

**SAMSUNG**

# PROJECTION TV RECEIVER

Chassis : P55A  
Model: HCM4215WX/XAA HCM422WX/XAA  
HCM4216WX/XAA

# **SERVICE** *Manual*

## PROJECTION TV RECEIVER

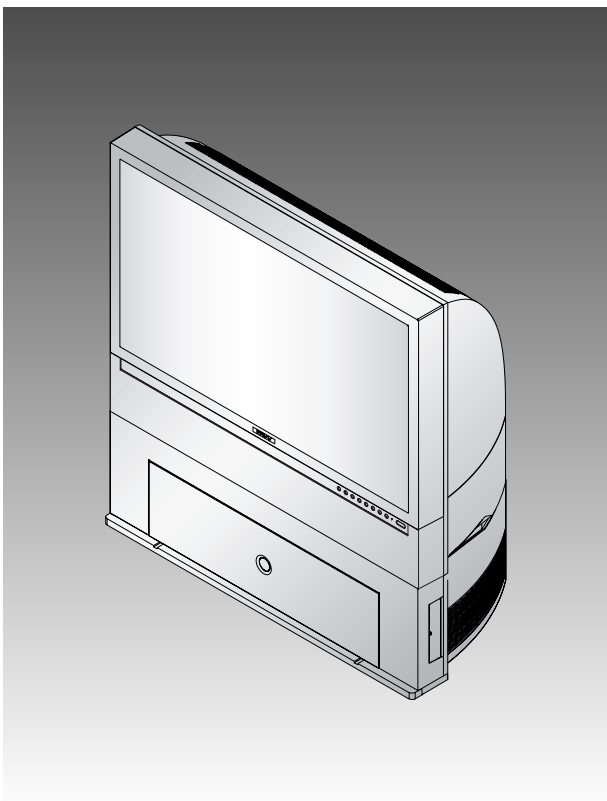

## CONTENTS

1. Precautions
2. Reference Information
3. Specifications
4. Alignment and Adjustments
5. Troubleshooting
6. Exploded View and Parts List
7. Electric Parts List
8. Block Diagrams
9. Wiring Diagram
10. Schematic Diagrams



## 1. Precautions

Follow these safety, servicing and ESD precautions to prevent damage and protect against potential hazards such as electrical shock and X-rays.

### 1-1 Safety Precautions

1. Be sure that all of the built-in protective devices are replaced. Restore any missing protective shields.
2. When reinstalling the chassis and its assemblies, be sure to restore all protective devices, including: nonmetallic control knobs and compartment covers.
3. Make sure that there are no cabinet openings through which people—particularly children—might insert fingers and contact dangerous voltages. Such openings include the spacing between the picture tube and the cabinet mask, excessively wide cabinet ventilation slots, and improperly fitted back covers.

If the measured resistance is less than 1.0 megohm or greater than 5.2 megohms, an abnormality exists that must be corrected before the unit is returned to the customer.

4. Leakage Current Hot Check (Figure 1-1):  
Warning: Do not use an isolation transformer during this test. Use a leakage-current tester or a metering system that complies with American National Standards Institute (ANIS C101.1, Leakage Current for Appliances), and Underwriters Laboratories (UL Publication UL1410, 59.7).
5. With the unit completely reassembled, plug the AC line cord directly into the power outlet. With the unit's AC switch first in the ON position and then OFF, measure the current between a known earth ground (metal water pipe, conduit, etc.) and all exposed metal parts, including: antennas, handle brackets, metal cabinets, screwheads and control shafts. The current measured should not exceed 0.5 milliamp. Reverse the power-plug prongs in the AC outlet and repeat the test.

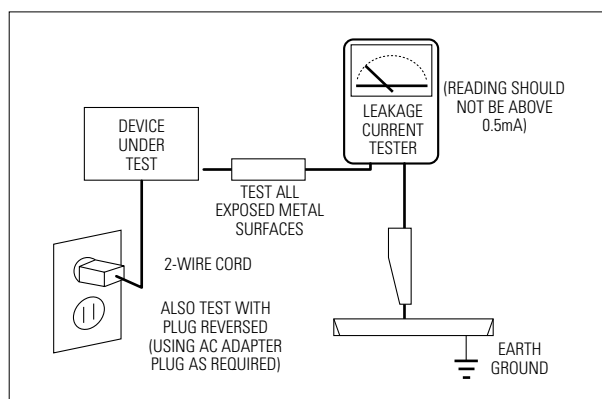



Fig. 1-1 AC Leakage Test

6. Antenna Cold Check:  
With the unit's AC plug disconnected from the AC source, connect an electrical jumper across the two AC prongs. Connect one lead of the ohmmeter to an AC prong. Connect the other lead to the coaxial connector.
7. X-ray Limits:  
The picture tube is especially designed to prohibit X-ray emissions. To ensure continued X-ray protection, replace the picture tube only with one that is the same type as the original. Carefully reinstall the picture tube shields and mounting hardware; these also provide X-ray protection.
8. High Voltage Limits:  
High voltage must be measured each time servicing is done on the B+, horizontal deflection or high voltage circuits. Correct operation of the X-ray protection circuits must be reconfirmed whenever they are serviced.  
(X-ray protection circuits also may be called "horizontal disable" or "hold-down".)

Heed the high voltage limits. These include the X-ray Protection Specifications Label, and the Product Safety and X-ray Warning Note on the service data schematic.

## 1-1 Safety Precautions (Continued)

---

9. High voltage is maintained within specified limits by close-tolerance, safety-related components and adjustments. If the high voltage exceeds the specified limits, check each of the special components.
10. Design Alteration Warning:  
Never alter or add to the mechanical or electrical design of this unit. Example: Do not add auxiliary audio or video connectors. Such alterations might create a safety hazard. Also, any design changes or additions will void the manufacturer's warranty.
11. Hot Chassis Warning:  
Some TV receiver chassis are electrically connected directly to one conductor of the AC power cord. If an isolation transformer is not used, these units may be safely serviced only if the AC power plug is inserted so that the chassis is connected to the ground side of the AC source.  
  
To confirm that the AC power plug is inserted correctly, do the following: Using an AC voltmeter, measure the voltage between the chassis and a known earth ground. If the reading is greater than 1.0V, remove the AC power plug, reverse its polarity and reinsert. Re-measure the voltage between the chassis and ground.
12. Some TV chassis are designed to operate with 85 volts AC between chassis and ground, regardless of the AC plug polarity. These units can be safely serviced only if an isolation transformer inserted between the receiver and the power source.
13. Some TV chassis have a secondary ground system in addition to the main chassis ground. This secondary ground system is not isolated from the AC power line. The two ground systems are electrically separated by insulating material that must not be defeated or altered.
14. Components, parts and wiring that appear to have overheated or that are otherwise damaged should be replaced with parts that meet the original specifications. Always determine the cause of damage or overheating, and correct any potential hazards.
15. Observe the original lead dress, especially near the following areas: Antenna wiring, sharp edges, and especially the AC and high voltage power supplies. Always inspect for pinched, out-of-place, or frayed wiring. Do not change the spacing between components and the printed circuit board. Check the AC power cord for damage. Make sure that leads and components do not touch thermally hot parts.
16. Picture Tube Implosion Warning:  
The picture tube in this receiver employs "integral implosion" protection. To ensure continued implosion protection, make sure that the replacement picture tube is the same as the original.
17. Do not remove, install or handle the picture tube without first putting on shatterproof goggles equipped with side shields. Never handle the picture tube by its neck. Some "in-line" picture tubes are equipped with a permanently attached deflection yoke; do not try to remove such "permanently attached" yokes from the picture tube.
18. Product Safety Notice:  
Some electrical and mechanical parts have special safety-related characteristics which might not be obvious from visual inspection. These safety features and the protection they give might be lost if the replacement component differs from the original—even if the replacement is rated for higher voltage, wattage, etc.  
  
Components that are critical for safety are indicated in the circuit diagram by shading, () or ().  
Use replacement components that have the same ratings, especially for flame resistance and dielectric strength specifications. A replacement part that does not have the same safety characteristics as the original might create shock, fire or other hazards.

## 1-2 Servicing Precautions

---

**Warning 1 :** First read the "Safety Precautions" section of this manual. If some unforeseen circumstance creates a conflict between the servicing and safety precautions, always follow the safety precautions.

**Warning 2 :** An electrolytic capacitor installed with the wrong polarity might explode.

1. Servicing precautions are printed on the cabinet. Follow them.
2. Always unplug the unit's AC power cord from the AC power source before attempting to: (a) Remove or reinstall any component or assembly, (b) Disconnect an electrical plug or connector, (c) Connect a test component in parallel with an electrolytic capacitor.
3. Some components are raised above the printed circuit board for safety. An insulation tube or tape is sometimes used. The internal wiring is sometimes clamped to prevent contact with thermally hot components. Reinstall all such elements to their original position.
4. After servicing, always check that the screws, components and wiring have been correctly reinstalled. Make sure that the portion around the serviced part has not been damaged.
5. Check the insulation between the blades of the AC plug and accessible conductive parts (examples: metal panels, input terminals and earphone jacks).
6. Insulation Checking Procedure: Disconnect the power cord from the AC source and turn the power switch ON. Connect an insulation resistance meter (500V) to the blades of the AC plug.  
  
The insulation resistance between each blade of the AC plug and accessible conductive parts (see above) should be greater than 1 megohm.
7. Never defeat any of the B+ voltage interlocks. Do not apply AC power to the unit (or any of its assemblies) unless all solid-state heat sinks are correctly installed.
8. Always connect a test instrument's ground lead to the instrument chassis ground before connecting the positive lead; always remove the instrument's ground lead last.
9. When some parts inside the optical engine (except lamp) are damaged, replace the whole optical engine.

**"CAUTION : Double-pole/neutral fusing"**

### 1-3 Precautions for Electrostatically Sensitive Devices (ESDs)

---

1. Some semiconductor (“solid state”) devices are easily damaged by static electricity. Such components are called Electrostatically Sensitive Devices (ESDs); examples include integrated circuits and some field-effect transistors. The following techniques will reduce the occurrence of component damage caused by static electricity.
2. Immediately before handling any semiconductor components or assemblies, drain the electrostatic charge from your body by touching a known earth ground. Alternatively, wear a discharging wrist-strap device. (Be sure to remove it prior to applying power—this is an electric shock precaution.)
3. After removing an ESD-equipped assembly, place it on a conductive surface such as aluminum foil to prevent accumulation of electrostatic charge.
4. Do not use freon-propelled chemicals. These can generate electrical charges that damage ESDs.
5. Use only a grounded-tip soldering iron when soldering or unsoldering ESDs.
6. Use only an anti-static solder removal device. Many solder removal devices are not rated as “anti-static”; these can accumulate sufficient electrical charge to damage ESDs.
7. Do not remove a replacement ESD from its protective package until you are ready to install it. Most replacement ESDs are packaged with leads that are electrically shorted together by conductive foam, aluminum foil or other conductive materials.
8. Immediately before removing the protective material from the leads of a replacement ESD, touch the protective material to the chassis or circuit assembly into which the device will be installed.
9. Minimize body motions when handling unpackaged replacement ESDs. Motions such as brushing clothes together, or lifting a foot from a carpeted floor can generate enough static electricity to damage an ESD.

#### CAUTION

These servicing instructions are for use by qualified service personnel only. To reduce the risk of electric shock do not perform any servicing other than that contained in the operating instructions unless you are qualified to do so.

## 2. Reference Information

### 2-1 Tables of Abbreviations and Acronyms

Table 2-1 Abbreviations

|      |  |     |                        |
|------|--|-----|------------------------|
| A    | Ampere                                 | MV  | Megavolt               |
| Ah   | Ampere-hour                            | MW  | Megawatt               |
| Å    | Angstrom                               | MΩ  | Megohm                 |
| dB   | Decibel                                | m   | Meter                  |
| dBm  | Decibel Referenced to One<br>Milliwatt | μA  | Microampere            |
| °C   | Degree Celsius                         | μF  | Microfarad             |
| °F   | Degree Fahrenheit                      | μH  | Microhenry             |
| °K   | degree Kelvin                          | μm  | Micrometer             |
| F    | Farad                                  | μs  | Microsecond            |
| G    | Gauss                                  | μW  | Microwatt              |
| GHz  | Gigahertz                              | mA  | Milliampere            |
| g    | Gram                                   | mg  | Milligram              |
| H    | Henry                                  | mH  | Millihenry             |
| Hz   | Hertz                                  | ml  | Milliliter             |
| h    | Hour                                   | mm  | Millimeter             |
| ips  | Inches Per Second                      | ms  | Millisecond            |
| kWh  | Kilowatt-hour                          | mV  | Millivolt              |
| kg   | Kilogram                               | nF  | Nanofarad              |
| kHz  | Kilohertz                              | Ω   | Ohm                    |
| kΩ   | Kilohm                                 | pF  | Picofarad              |
| km   | Kilometer                              | lb  | Pound                  |
| km/h | Kilometer Per Hour                     | rpm | Revolutions Per Minute |
| kV   | Kilovolt                               | rps | Revolutions Per Second |
| kVA  | Kilovolt-ampere                        | s   | Second (Time)          |
| kW   | Kilowatt                               | V   | Volt                   |
| l    | Liter                                  | VA  | Volt-ampere            |
| MHz  | Megahertz                              | W   | Watt                   |
|      |  | Wh  | Watt-hour              |

Table 2-2 Table of Acronyms

|       |   |        |   |
|-------|---|--------|---|
| ABL   | Automatic Brightness Limiter            | I/O    | Input/output                              |
| AC    | Alternating Current                     | L      | Left                                      |
| ACC   | Automatic Chroma Control                | L      | Low                                       |
| AF    | Audio Frequency                         | LED    | Light Emitting Diode                      |
| AFC   | Automatic Frequency Control             | LF     | Low Frequency                             |
| AFT   | Automatic Fine Tuning                   | MOSFET | Metal-Oxide-Semiconductor-Field-Effect-Tr |
| AGC   | Automatic Gain Control                  | MTS    | Multi-channel Television Sound            |
| AM    | Amplitude Modulation                    | NAB    | National Association of Broadcasters      |
| ANSI  | American National Standards Institute   | NEC    | National Electric Code                    |
| APC   | Automatic Phase Control                 | NTSC   | National Television Systems Committee     |
| APC   | Automatic Picture Control               | OSD    | On Screen Display                         |
| A/V   | Audio-Video                             | PCB    | Printed Circuit Board                     |
| AVC   | Automatic Volume Control                | PLL    | Phase-Locked Loop                         |
| BAL   | Balance                                 | PWM    | Pulse Width Modulation                    |
| BPF   | Bandpass Filter                         | QIF    | Quadrature Intermediate Frequency         |
| B-Y   | Blue-Y                                  | R      | Right                                     |
| CATV  | Community Antenna Television (Cable TV) | RC     | Resistor & Capacitor                      |
| CB    | Citizens Band                           | RF     | Radio Frequency                           |
| CCD   | Charge Coupled Device                   | R-Y    | Red-Y                                     |
| CCTV  | Closed Circuit Television               | SAP    | Second Audio Program                      |
| Ch    | Channel                                 | SAW    | Surface Acoustic Wave(Filter)             |
| CRT   | Cathode Ray Tube                        | SIF    | Sound Intermediate Frequency              |
| CW    | Continuous Wave                         | SMPS   | Switching Mode Power Supply               |
| DC    | Direct Current                          | S/N    | Signal/Noise                              |
| DVM   | Digital Volt Meter                      | SW     | Switch                                    |
| EIA   | Electronics Industries Association      | TP     | Test Point                                |
| ESD   | Electrostatic Discharge                 | TTL    | Transistor Transistor Logic               |
| ESD   | Electrostatically Sensitive Device      | TV     | Television                                |
| FBP   | Feedback Pulse                          | UHF    | Ultra High Frequency                      |
| FBT   | Flyback Transformer                     | UL     | Underwriters Laboratories                 |
| FF    | Flip-Flop                               | UV     | Ultraviolet                               |
| FM    | Frequency Modulation                    | VCD    | Variable-Capacitance Diode                |
| FS    | Fail Safe                               | VCO    | Voltage Controlled Oscillator             |
| GND   | Ground                                  | VCXO   | Voltage Controlled Crystal Oscillator     |
| G-Y   | Green-Y                                 | VHF    | Very High Frequency                       |
| H     | High                                    | VIF    | Video Intermediate Frequency              |
| HF    | High-Frequency                          | VR     | Variable Resistor                         |
| HI-FI | High Fidelity                           | VTR    | Video Tape Recorder                       |
| IC    | Inductance-Capacitance                  | VTVM   | Vacuum Tube Voltmeter                     |
| IC    | Integrated Circuit                      | TR     | Transistor                                |
| IF    | Intermediate Frequency                  |        |   |



## 2-2 Description of Dynamic Focus

Most large-screen video display devices that are using CRT (including CDT) usually apply the Dynamic Focus (hereinafter D/F) circuit.

As CRT has non-spherical surface (perfect spherical surface = 1, non-spherical surface  $R > 1$ ), the distance that the electron beam emitted from the electron gun reaches to the center of CRT is different from the one that the electron beam reaches to the corners. (See Figure 1.)

Only the beam, which has the equal distance as the beam from the electron gun to the center of CRT surface, can maintain the optimum focus.

By this reason, focus degradation at corners occurs inevitably.

To recover this, the speed of the electron beam injected into the corners of CRT should increase and the focus degradation by the difference of distances can be compensated.

Increasing the voltage is used as a method of increasing the speed of the electron beam at the corners of screen.

In this case, an ideal D/F voltage waveform is the form of parabola where the center of screen has low voltage and the corners has the highest voltages.

The horizontal D/F waveform compensates the focus degradation at left and right sides, but the vertical D/F waveform does at top and bottom sides.

The horizontal D/F and vertical D/F waveforms are separately created and mix two signals to compensate the focus of the whole screen.

And the vertical Dynamic Focus waveform is composed of the horizontal Dynamic Focus waveforms as much as the number of scanning lines. (See Figure 2.)

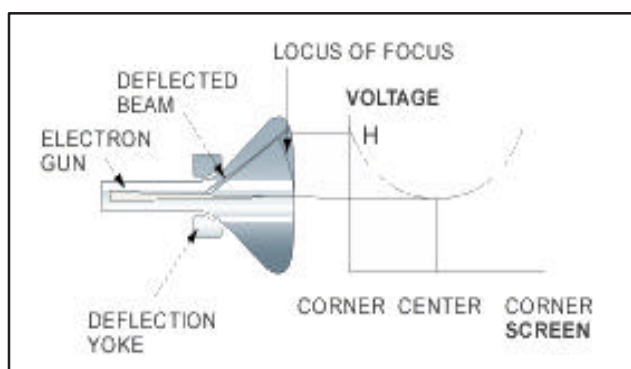

Fig. 1 Dynamic Focus Diagram (Horizontal)

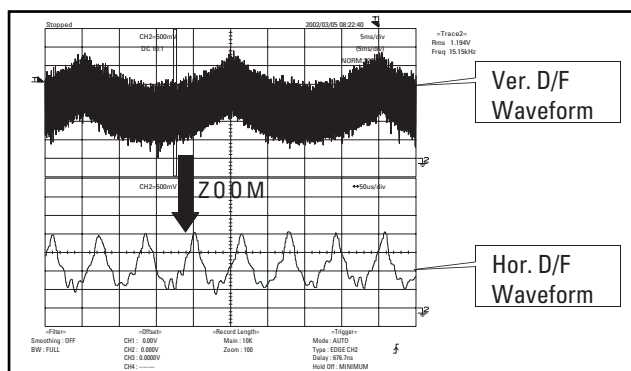

Fig. 2 H/V Dynamic Focus Waveform

## 2-3 IC Line Up

### 2-3-1 Progressive

| Table 2 - 3 IC Line - Up |            |             |                                |                    |
|--------------------------|------------|-------------|--------------------------------|--------------------|
| No                       | Block Name | IC Location | IC Name                        | CODE-NO            |
| 1                        | MAIN       | IC601       | TDA7265                        | AA96-00623E (ASSY) |
|                          |            | IC602       | MSP3420G (QFP)                 | 1204-002002        |
|                          |            | IC603       | TL062CDT (SOP)                 | 1201-000541        |
|                          |            | IC604       | TL062CDT (SOP)                 | 1201-000541        |
|                          |            | IC605       | TEA6422D (SOP)                 | 1001-001178        |
|                          |            | IC701       | TEA6425D (SOP)                 | 1001-001177        |
|                          |            | IC702       | TEA6425D (SOP)                 | 1001-001177        |
|                          |            | IC704       | PCF8591T                       | 1002-001048        |
|                          |            | IC801       | KA278RA05 X 3EA<br>+78R09+7808 | AA96-00475B (ASSY) |
|                          |            | IC802       | 7905 (DIP)                     | 1203-000119        |
|                          |            | IC807       | 78R12 (DIP)                    | 1203-000165        |
|                          |            | IC808       | SI-3050C                       | BP96-00020G (ASSY) |
| 2                        | Micom      | IC901       | SDA5550M (QGP)                 | 204-001912         |
|                          |            | IC902       | 24C16 (SOP)                    | 1103-000180        |
|                          |            | IC903       | 78RM33D                        | 1203-002302        |
|                          |            | IC905       | M27W201-80F6 (DIP)             | 1102-001130        |
| 3                        | PRO-SCAN   | IC01        | VSP9407 (QFP)                  | 1204-001938        |
|                          |            | IC02        | CXA2151Q (QFP)                 | 1204-001814        |
|                          |            | IC03        | BA7657F (SOP)                  | 1001-001082        |
|                          |            | IC04        | CXA2165Q (QFP)                 | 1204-001989        |
|                          |            | IC05        | LF18                           | 1203-002186        |
|                          |            | IC06        | 7027                           | 1203-001211        |
|                          |            | IC11        | 78RM33D                        | 1203-002302        |
|                          |            | IC13        | 74HC123 (SOP)                  | 0801-000662        |
| 4                        | CG-MDL     | IC01        | SDC12 (QFP)                    | BP13-00003A        |
|                          |            | IC02        | 78RM33D                        | 1203-002302        |

| Table 2 - 3 IC Line - Up (Continued) |              |                 |                     |             |          |             |
|--------------------------------------|--------------|-----------------|---------------------|-------------|----------|-------------|
| No                                   | Block Name   | IC Location     | IC Name             | CODE-NO     |          |             |
| 4                                    | CG-MDL       | IC03            | 7042                | 1203-001824 |          |             |
|                                      |              | IC04            | 7S04                | 0801-002345 |          |             |
|                                      |              | IC05            | 24C64 (SOP)         | 1103-001195 |          |             |
|                                      |              | IC06            | TSC871251G2D (PLCC) | AA09-00032A |          |             |
|                                      |              | IC07            | EL2250CS (SOP)      | 1201-001520 |          |             |
|                                      |              | IC08            | 74HC4052 (SOP)      | 1001-000164 |          |             |
|                                      |              | IC09            | 072 (SOP)           | 1201-001504 |          |             |
|                                      |              | IC10            | 072 (SOP)           | 1201-001504 |          |             |
|                                      |              | IC11            | 072 (SOP)           | 1201-001504 |          |             |
|                                      |              | IC12            | LM324AM (SOP)       | 1201-001135 |          |             |
|                                      |              | IC13            | NC7SB3157 (SOT)     | 1001-001155 |          |             |
|                                      |              | IC14            | 072 (SOP)           | 1201-001504 |          |             |
|                                      |              | IC15            | 7S04 (SOP)          | 0801-002345 |          |             |
|                                      |              | IC16            | 7S04 (SOP)          | 0801-002345 |          |             |
|                                      |              | IC17            | TLC2932IPWLE (SOP)  | 1209-001163 |          |             |
|                                      |              | 5               | SUB                 | ICS801      | VIPER12A | 1203-002177 |
|                                      |              |                 |                     | ICS802      | KA7805   | 1203-000568 |
| IC301                                | LA7845       |                 |                     | 1204-000517 |          |             |
| IC421                                | 78R12        |                 |                     | 1203-000165 |          |             |
| IC430                                | 317 (TO-220) |                 |                     | 1203-000161 |          |             |
| IC431                                | MC4558C      |                 |                     | 1201-000191 |          |             |
| IC471                                | TL494CN      |                 |                     | 1203-000610 |          |             |
| IC831S                               | STR-X6456    |                 |                     | AA13-00105A |          |             |
| IC851                                | SE110N       |                 |                     | 1203-001400 |          |             |
| ICR01S                               | 431 (TO-92)  |                 |                     | 1203-001217 |          |             |
| PC801S                               | PS2561       |                 |                     | 0604-001032 |          |             |
| PC811S                               | PS2561       |                 |                     | 0604-001032 |          |             |
| 6                                    | CRT          | IC501, 531, 561 | TDA6111Q            | 1201-001131 |          |             |
| 7                                    | CG-AMP       | ICZ103, 104     | STK392-010          | 1201-001512 |          |             |

## 2-4 MICOM IIC BUS LINE -UP

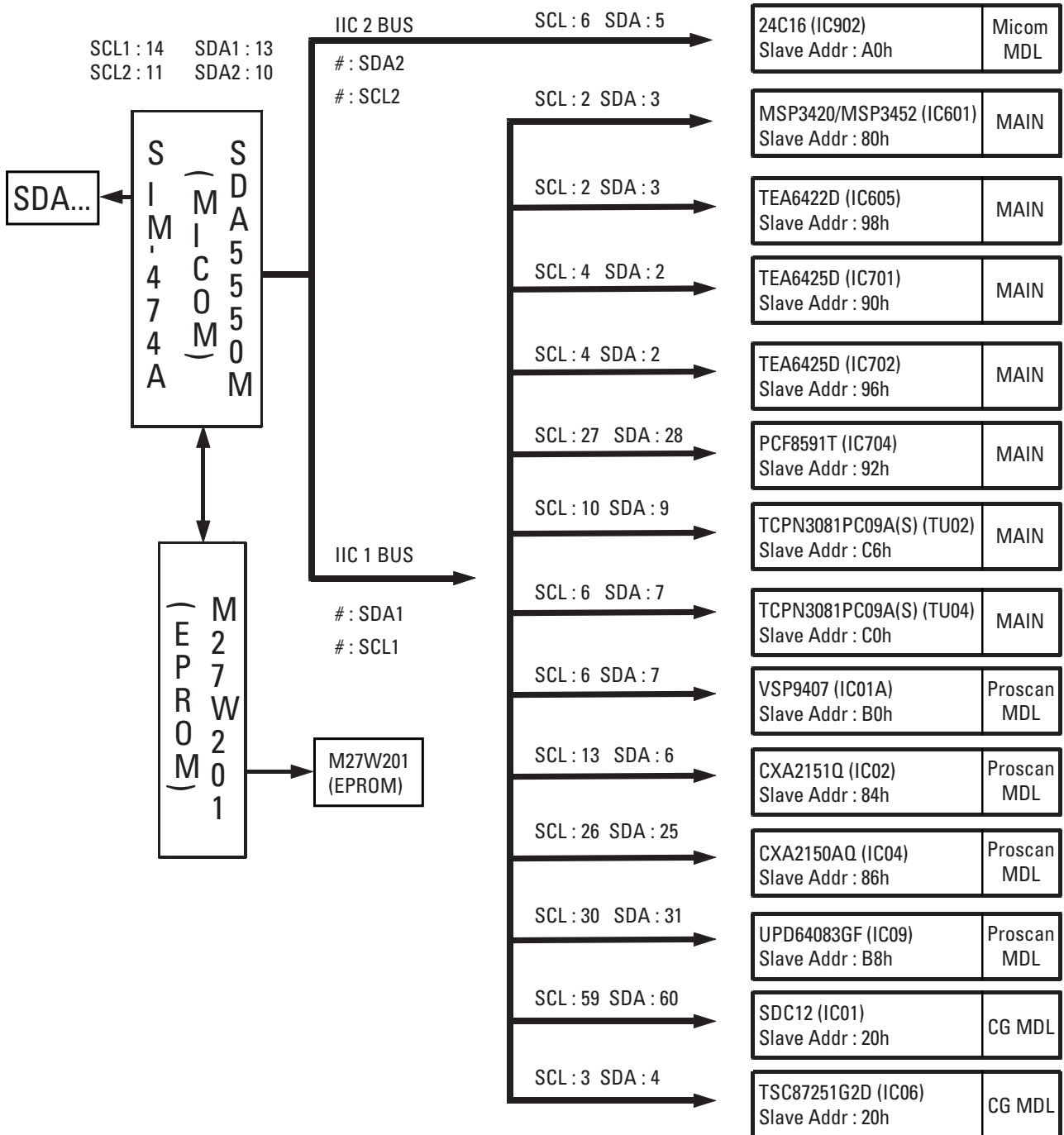

### 3. Specifications

|                        |  |
|------------------------|--|
| Broadcasting System    | NTSC   |
| Scanning System        | Progressive Scanning   |
| Tuning Range           | VHF : CH2 ~ CH13   |
| Antenna Impedance      | 75 ohm Unbalanced  |
| Intermediate Frequency | Video : 45.75 MHz<br>Sound : 42.25 MHz<br>Chrominance Subcarrier : 42.17 MHz |
| Sound Output           | STD : 10W<br>MAX : 15W   |
| Rated Voltage          | 120V / 60 Hz   |
| W/B Coordinates        | Hx : 266      Hy : 280      Y : 8.9<br>Lx : 268      Ly : 283      Y : 0.38  |
| High Voltage           | 29KV   |
| FUSE                   | 250V/6.3A<br>CODE NO : 3601-000300   |
| Power Consumption      | 240W   |
| Dimension              | 1002 X 450 X 1070mm<br>39.4 X 17.7 X 42.1 inch                               |
| Weight                 | 49Kg 108lbs  |

# MENO

## 4. Alignment and Adjustments

### 4-1 When entering the service mode:

1. Turn on the TV, and then select "STANDARD" on the picture adjustment mode.
2. Turn off the TV (STAND-BY).
3. Enter the service mode by pressing the remote control keys in the following sequence :

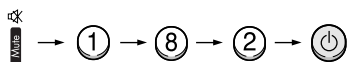

Note : If necessary, re-do steps 1~3.

Initial display when the service mode is switched.

1. When a RF signal is received

|                      |
|----------------------|
| SERVICE / Sim-474A   |
| DEFLECTION           |
| 480P OFFSET          |
| 1080i OFFSET         |
| CONVERGENCE OFFSET   |
| VIDEO ADJUST 1       |
| VIDEO ADJUST 2       |
| VIDEO ADJUST 3       |
| VIDEO ADJUST 4       |
| OPTION (E3h 98h 0ch) |
| RESET / 02-05-03     |

3. Service Mode Control Keys

|             |  |
|-------------|--|
| MAIN MENU   | MENU DISPLAY                               |
| CH UP/DOWN  | Select item by moving cursor               |
| VOL UP/DOWN | Decrease or increase the adjustment values |

#### < PRECAUTIONS >

1. When EEPROM IC (IC902) is replaced, first connect the power cord and wait for about 4~5 seconds.
2. After replacing EEPROM IC (IC902), enter the Service mode. Next, enter the standard data or the previous EEPROM IC data before replacement. And then check and adjust any items related to Geometric, Picture, Option.

## 4-2 Factory Data

---

### 4-2-1 Defection

| ITEM            | INITIAL DATA | Range  | EEP-ROM Copy Data |      |       | Remark   |
|-----------------|--------------|--------|-------------------|------|-------|----------|
|                 |              |        | RF                | 480P | 1080i |          |
| V Amp           |              | 0 ~ 63 | 31                | -    | -     | variable |
| V Shift         | 32           | 0 ~ 63 | 29                | -    | -     | fix      |
| H EW            |              | 0 ~ 63 | 31                | -    | -     | variable |
| H Shift         | 32           | 0 ~ 63 | 31                | -    | -     | fix      |
| V Linearity     | 6            | 0 ~ 15 | 7                 | -    | -     | fix      |
| Upper Linearity | 7            | 0 ~ 15 | 0                 | -    | -     | fix      |
| Lower Linearity | 8            | 0 ~ 15 | 0                 | -    | -     | fix      |
| VSC             | 3            | 0 ~ 15 | 7                 | -    | -     | fix      |
| H Parabola      | 10           | 0 ~ 63 | 31                | -    | -     | fix      |
| Upper Corner    | 32           | 0 ~ 63 | 31                | -    | -     | fix      |
| Lower Corner    | 32           | 0 ~ 63 | 31                | -    | -     | fix      |
| H Trapezium     | 32           | 0 ~ 63 | 31                | -    | -     | fix      |
| Bow             | 32           | 0 ~ 63 | 31                | -    | -     | fix      |
| Angel           | 32           | 0 ~ 63 | 31                | -    | -     | fix      |
| V Position      | 32           | 0 ~ 63 | 31                | -    | -     | fix      |
| CXA Left Blk    | 35           | 0 ~ 63 | 35                | -    | -     | fix      |
| CXA Right Blk   | 35           | 0 ~ 63 | 35                | -    | -     | fix      |



## 4-2-2 480P Offset

| ITEM            | INITIAL DATA | Range    | EEP-ROM Copy Data |      |       | Remark   |
|-----------------|--------------|----------|-------------------|------|-------|----------|
|                 |              |          | RF                | 480P | 1080i |          |
| V Amp           | 0            | -63 ~ 63 | -                 | 0    | -     | variable |
| V Shift         | 0            | -63 ~ 63 | -                 | 0    | -     | variable |
| H EW            | 0            | -63 ~ 63 | -                 | 0    | -     | variable |
| H Shift         | 0            | -63 ~ 63 | -                 | 0    | -     | variable |
| V Linearity     | 0            | -15~ 15  | -                 | 0    | -     | fix      |
| Upper Linearity | 0            | -15~ 15  | -                 | 0    | -     | fix      |
| Lower Linearity | 0            | -15~ 15  | -                 | 0    | -     | fix      |
| VSC             | 0            | -15~ 15  | -                 | 0    | -     | fix      |
| H Parabola      | 0            | -63 ~ 63 | -                 | 0    | -     | fix      |
| Upper Corner    | 0            | -63 ~ 63 | -                 | 0    | -     | fix      |
| Lower Corner    | 0            | -63 ~ 63 | -                 | 0    | -     | fix      |
| H Trapezium     | 0            | -63 ~ 63 | -                 | 0    | -     | fix      |
| Bow             | 0            | -63 ~ 63 | -                 | 0    | -     | fix      |
| Angel           | 0            | -63 ~ 63 | -                 | 0    | -     | fix      |
| V Position      | 0            | -63 ~ 63 | -                 | 0    | -     | fix      |
| CXA Left Blk    |              | -63 ~ 63 | -                 | 28   | -     | fix      |
| CXA Right Blk   |              | -63 ~ 63 | -                 | 36   | -     | fix      |

**4-2-3 1080i Offset**

| ITEM            | INITIAL DATA | Range    | EEP-ROM Copy Data |      |       | Remark   |
|-----------------|--------------|----------|-------------------|------|-------|----------|
|                 |              |          | RF                | 480P | 1080i |          |
| V Amp           | 0            | -63 ~ 63 | -                 | -    | 0     | variable |
| V Shift         | 0            | -63 ~ 63 | -                 | -    | 0     | variable |
| H EW            | 0            | -63 ~ 63 | -                 | -    | 0     | variable |
| H Shift         | 0            | -63 ~ 63 | -                 | -    | 0     | fix      |
| V Linearity     | 0            | -15~ 15  | -                 | -    | 0     |          |
| Upper Linearity | 0            | -15~ 15  | -                 | -    | 0     |          |
| Lower Linearity | 0            | -15~ 15  | -                 | -    | 0     |          |
| VSC             | 0            | -15~ 15  | -                 | -    | 0     |          |
| H Parabola      | 0            | -63 ~ 63 | -                 | -    | 0     |          |
| Upper Corner    | 0            | -63 ~ 63 | -                 | -    | 0     |          |
| Lower Corner    | 0            | -63 ~ 63 | -                 | -    | 0     |          |
| H Trapezium     | 0            | -63 ~ 63 | -                 | -    | 0     |          |
| Bow             | 0            | -63 ~ 63 | -                 | -    | 0     |          |
| Angel           | 0            | -63 ~ 63 | -                 | -    | 0     |          |
| V Position      | 0            | -63 ~ 63 | -                 | -    | 0     |          |
| CXA Left Blk    |              | -63 ~ 63 | -                 | -    | 63    |          |
| CXA Right Blk   |              | -63 ~ 63 | -                 | -    | 20    |          |

**4-2-4 CONVERGRNCE OFFSET**

| ITEM          | INITIAL DATA | Range    | EEP-ROM Copy Data |      |       | Remark   |
|---------------|--------------|----------|-------------------|------|-------|----------|
|               |              |          | RF                | 480P | 1080i |          |
| Offset Enable | 0            | 0 ~ 1    | 0                 |      |       | variable |
| V Amp         | 15           | -63 ~ 63 | 15                |      |       | variable |
| V Shift       | 0            | -63 ~ 63 | 0                 |      |       | variable |
| H EW          | 15           | -63 ~ 63 | 15                |      |       | variable |
| V Amp 1080i   | 15           | -63 ~ 63 | 15                |      |       | variable |
| V Shift 1080i | 0            | -63 ~ 63 | 0                 |      |       | variable |
| H EW 1080i    | 15           | -63 ~ 63 | 15                |      |       | variable |

**4-2-5 VIDEO ADJUST 1**

| ITEM         | INITIAL DATA | Range  | EEP-ROM Copy Data           |                      |       | Remark   |
|--------------|--------------|--------|-----------------------------|----------------------|-------|----------|
|              |              |        | RF-Copy                     | W/B<br>Control Value | 1080i |          |
| R Cutoff     | 20           | 0 ~ 63 | 31                          | 20                   | 31    | variable |
| G Cutoff     | 20           | 0 ~ 63 | 31                          | 20                   | 31    | variable |
| B Cutoff     | 20           | 0 ~ 63 | 31                          | 20                   | 31    | fix      |
| Color On/Off | 1            | 0 ~ 1  |                             | 1                    |       |          |
| CR offset    | 32           | 0 ~ 15 | 32                          |                      |       | fix      |
| CB offset    | 32           | 0 ~ 15 | 32                          |                      |       | fix      |
| R Driver     | 31           | 0 ~ 15 | 20                          | 31                   | 20    | variable |
| G Driver     | 31           | 0 ~ 15 | 20                          | 31                   | 20    | fix      |
| B Driver     | 31           | 0 ~ 63 | 20                          | 31                   | 20    | variable |
| Sub Bright   | 15           | 0 ~ 63 |                             | 15                   |       | variable |
| Sub Contrast | 7            | 0 ~ 15 |                             | 7                    |       | variable |
| Sub Color    | 20           | 0 ~ 23 |                             | 20                   |       |          |
| SubTint      | 7            | 0 ~ 13 | 8(AV/SV/DVD/480P)           |                      | 10    | fix      |
| CTI Level    | 1            | 0 ~ 3  | 1 (RF/AV/SV/DVD/480P/1080i) |                      |       | fix      |
| CDL AXIS     | 2            | 0 ~ 3  | 2                           |                      |       | fix      |
| LTI Level    | 0            | 0 ~ 3  | 1(RF/AV/SV/DVD/480P)        |                      | 2     | fix      |

## 4-2-6 VIDEO ADJUST 2

| ITEM          | INITIAL DATA | Range  | EEP-ROM Copy Data           |                     |          | Remark |
|---------------|--------------|--------|-----------------------------|---------------------|----------|--------|
|               |              |        | RF                          | 480P                | 1080i    |        |
| ABL Mode      | 3            | 0 ~ 3  | 3                           |                     |          | fix    |
| Gamma         | 2            | 0 ~ 3  | 1                           |                     |          | fix    |
| DPIC Level    | 3            | 0 ~ 3  | 3                           |                     |          | fix    |
| DC Trans      | 3            | 0 ~ 3  | 1                           |                     |          | fix    |
| ABL TH        | 15           | 0 ~ 15 | 15                          |                     |          | fix    |
| VM Level      | 2            | 0 ~ 3  | 2                           |                     |          | fix    |
| VM Coring     | 0            | 0 ~ 3  | 0                           |                     |          |        |
| VM f0         | 0            | 0 ~ 3  | 2 (RF/AV/SV/DVD/480P)       |                     | 1        | fix    |
| VM Limit      | 0            | 0 ~ 3  | 0                           |                     |          |        |
| VM Delay      | 0            | 0 ~ 3  | 0 (RF/AV/DVD)               |                     | 1 (480P) | fix    |
| SHP CD        | 1            | 0 ~ 3  | 1                           |                     |          |        |
| SHP f0        | 0            | 0 ~ 1  | 0                           | 1 (AV/SV/DVD/Comp2) |          | fix    |
| SHP f1 & P/O  | 11           | 0 ~ 15 | 13 1 (RF/AV/SVHS/DVD/Comp2) |                     |          | fix    |
| AKB Time      | 13           | 0 ~ 31 | 16                          |                     |          |        |
| Y/C Delay     | 30           | 0 ~ 31 | 30                          |                     |          |        |
| PIP Y/C Delay | 30           | 0 ~ 31 | 30                          |                     |          |        |
| BAND PASS F   | 1            | 0 ~ 7  | 1                           |                     |          |        |
| HIGH PASS F   | 3            | 0 ~ 7  | 3                           |                     |          |        |

**4-2-7 VIDEO ADJUST 3**

| ITEM           | INITIAL DATA | Range  | EEP-ROM Copy Data |      |       | Remark |
|----------------|--------------|--------|-------------------|------|-------|--------|
|                |              |        | RF                | 480P | 1080i |        |
| VSU            | 2            | 0 ~ 15 | 2                 | -    | -     |        |
| Melody Volume  | 4            | 0 ~ 20 | 4                 | -    | -     |        |
| H Comp         | 0            | 0 ~ 15 | 0                 | -    | -     |        |
| V Comp         | 0            | 0 ~ 15 | 0                 | -    | -     |        |
| Pin Comp       | 0            | 0 ~ 15 | 0                 | -    | -     |        |
| AFC Comp       | 0            | 0 ~ 7  | 0                 | -    | -     |        |
| Sync Comp      | 0            | 0 ~ 1  | 0                 | -    | -     |        |
| NR Off Value   | 5            | 0 ~ 9  | 5                 | -    | -     |        |
| V-Mute(x100ns) | 8            | 0 ~ 10 | 8                 | -    | -     |        |

## 4-2-8 VIDEO ADJUST 4

| ITEM              | INITIAL DATA | Range  | EEP-ROM Copy Data |                |       | Remark |
|-------------------|--------------|--------|-------------------|----------------|-------|--------|
|                   |              |        | RF                | 480P           | 1080i |        |
| System RF         | 1            | 0 ~ 3  | 2                 |                |       |        |
| System_VSD_480P   | 1            | 0 ~ 3  |                   | 1              |       |        |
| System_1080i      | 1            | 0 ~ 3  |                   |                | 2     | fix    |
| Shp_Fo_VSD_480P   | 1            | 0 ~ 1  |                   | 1              |       |        |
| HPF_VSD           | 3            | 0 ~ 7  | 3                 | 3 (AVS/SV/DVD) |       |        |
| BPF_VSD           | 1            | 0 ~ 7  | 1                 | 1 (AVS/SV/DVD) |       | fix    |
| Chrm_bdwth_RF     | 28           | 0 ~ 63 | 28                |                |       | fix    |
| Chrm_bdwth_Video  | 28           | 0 ~ 63 | 28                |                |       | fix    |
| Chrm_bdwth_Svideo | 30           | 0 ~ 63 | 30                |                |       | fix    |
| Chrm_bdwth_DVD    | 28           | 0 ~ 63 | 28                |                |       | fix    |
| IF_Comp_RF        | 2            | 0 ~ 7  | 2                 |                |       | fix    |
| IF_Comp_Video     | 4            | 0 ~ 7  | 4                 |                |       | fix    |
| IF_Comp_Svideo    | 5            | 0 ~ 7  | 5                 |                |       | fix    |
| IF_Comp_DVD       | 4            | 0 ~ 7  | 4                 |                |       | fix    |
| VM_Delay_480P     | 1            | 0 ~ 3  |                   | 1              |       | fix    |

**4-2-9 OPTION**

| ITEM           | INITIAL DATA | Range                      | Option | Remark |
|----------------|--------------|----------------------------|--------|--------|
| CRT            | WIDE         | WIDE ↔ 4:3                 | WIDE   |        |
| PIP            | ON           | ON ↔ OFF                   | ON     |        |
| 3D-Comb Filter | OFF          | ON ↔ OFF                   | OFF    |        |
| Blue Screen    | OFF          | ON ↔ OFF                   | OFF    |        |
| BBE Effect     | ON           | ON ↔ OFF                   | ON     |        |
| Auto power On  | ON           | ON ↔ OFF                   | ON     |        |
| System         | CT           | CT (EN+SP+ER)→CT-A(E+SP+F) | CT     |        |
| Virtual Dolby  | OFF          | ON ↔ OFF                   | OFF    |        |
| ACS            | ON           | ON ↔ OFF                   | ON     |        |
| Vchip (CT,CTA) | ON           | ON ↔ OFF                   | ON     |        |
| Vchop Area     | USA          | USA                        | USA    |        |
| Sub Woofer     | OFF          | ON ↔ OFF                   | OFF    |        |
| No Sync Mute   | ON           | ON ↔ OFF                   | ON     |        |
| X-Lay          | ON           | ON ↔ OFF                   | ON     |        |
| AGC            | OFF          | ON ↔ OFF                   | OFF    |        |
| Tubo Effect    | OFF          | ON ↔ OFF                   | OFF    |        |
| Burst Screen   | OFF          | ON ↔ OFF                   | OFF    |        |
| DW Multi       | Large        | Large ↔ Double             | Large  |        |
| Letter Box     | ON           | ON ↔ OFF                   | ON     |        |



### 4-3 Screen Change (When adjusting I<sup>2</sup>C Bus Geometric items)

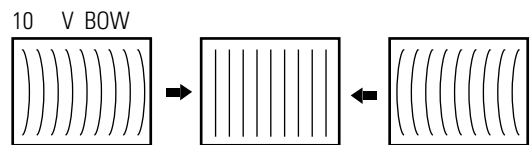
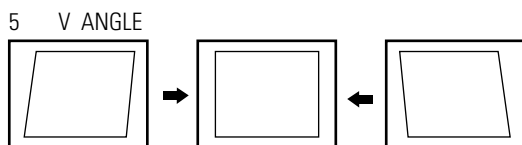
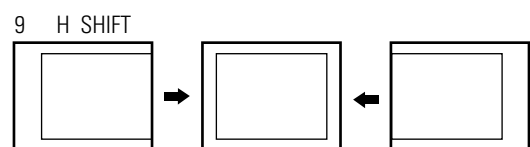
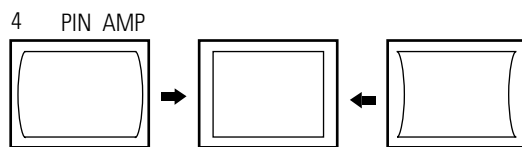
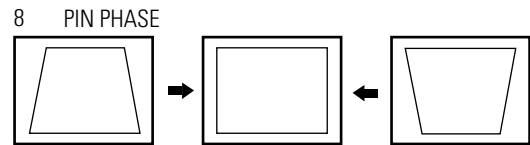
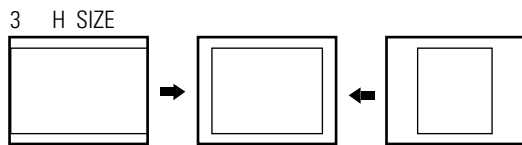
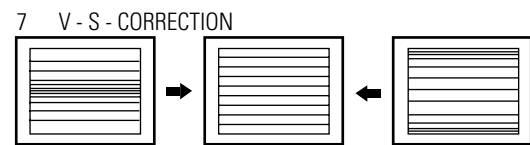
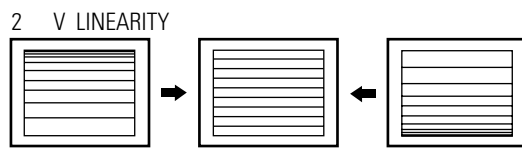
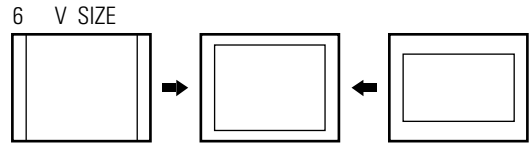
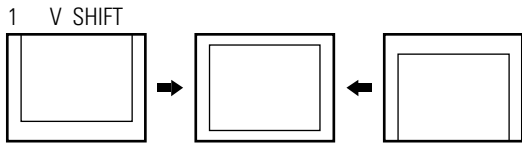

## 4-4 Other Adjustments

### 4-4-1 Screen Adjustment

1. Warm up the TV for at least 30 minutes.
2. Select the "STANDARD" Video mode.
3. Turn to the Video Mode (No Signal) using a remote-control.
4. Connect an oscilloscope to RK,GK,BK.
5. Adjust the VR (VR501, VR531, VR561) screen so that RK, GK, BK pulse is 20Vp-p each. (Turn the R,G,B VR screen fully counterclockwise in the area of each flyback line.)

### 4-4-2 White Balance Adjustment

1. Select the "STANDARD" video mode.
2. Input 100% white pattern.
3. In the stand-by mode, press the remote-control keys in the following sequence:

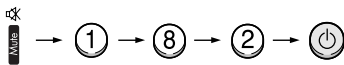

4. Warm up the TV for at least 30 minutes.
5. Input a 10-step signal.
6. R-cut off, B-cut off, and G-cut off by pressing the Volume keys.
7. Adjust the low light with viewing the dark side of the screen.
8. Select R-drive, G-drive, and B-drive by pressing the Volume keys.
9. Adjust the high light with viewing the light side of the screen.
10. If necessary, redo adjustments 6~9.
11. Press the Menu key to exit.

### 4-4-3 Sub-Brightness Adjustment

1. Input a sub-brightness adjustment signal. (TOSHIBA PATTERN)

2. In the stand-by mode, press the remote-control keys in the following sequence :

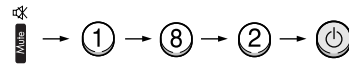

3. Select SBT by pressing the Volume keys.
4. Adjust so that the 63 step on the right side of the screen is not seen (Use the Volume keys).
5. Press the Menu key to exit.

### 4-4-4 High Voltage (29KV) Check

#### PRECAUTION

1. Input a lion head pattern.
2. Select "STANDARD" video mode.
3. Warm up the TV for at least 10 minutes.
4. Use a 1000:1 probe.

#### ADJUSTMENT

1. Connect the (+) terminal of the 1000:1 probe to the high voltage distributor and the (-) terminal to GND (located on the deflection board).
2. Adjust RR471S (located on the deflection board) so that the digital meter indicates  $DC\ 29V \pm 0.1V$ .

### 4-4-5 F.S. (Fail Safe) Adjustment

Note : The finished product has a well-mounted VR (RR402S).  
If necessary, do the F.S. adjustments in the following sequence.

1. Use a digital multimeter.
2. Connect the digital multimeter to the JIG pin (DZ482S) terminals
3. Adjust VR (RR402S) so that the voltage becomes 2.25V.
4. After the adjustments are complete, be sure to mount VR (RR402S) correctly.

### 4-4-6 F.S. (Fail Safe) Circuit Check

Note : The F.S. Circuit check must be performed after servicing.

1. Turn on the TV.
2. Select the "STANDARD" video mode.
3. Short F/S Test point (located on the SUB PCB). Then, both sound and picture disappear. (Note: Even if the shorted terminals are removed, both sound and picture do not appear. This proves the F.S. circuit is working. )
4. To restore both sound and picture, turn off the TV and reset it after about 30 seconds.

### 4-4-7 Static Focus Adjustment

#### PRECAUTION

1. Select the "STANDARD" video mode.
2. Input a crosshatch pattern.
3. Cover the lenses that are not being adjusted.
4. Connect a convergence jig and read data.
5. Adjust the lens for best focus. (See Fig. 4-1)

#### STATIC FOCUS (CONTINUED)

Vary the focus pack VR (Red, Blue) on the front cabinet. Adjust the TV for best possible focus around the center of the crosshatch pattern, without losing overall screen balance. Figure Crosshatch Pattern  
Examine these points together.

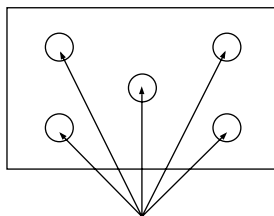

Examine these points together

Fig. 4-1 Crosshatch Pattern.

### 4-4-8 Lens Focus Adjustment

#### PRECAUTIONS

1. Do this adjustment after the static focus adjustment and the tilt adjustment.
2. Select the "STANDARD" video mode. (Contrast:100, Brightness:50)
3. Input a crosshatch pattern.

#### ADJUSTMENT

1. Loosen the lens screws.
2. Cover the two lenses that are not being adjusted.
3. Adjust the lens, observing the color aberration vertically and horizontally within 3 blocks of the center of the crosshatch pattern.
4. When the lens is turned clockwise, the color aberration will change as follows:

| <u>Lens</u> | <u>Color Aberration Change</u> |
|-------------|--------------------------------|
| R           | Orange - Crimson               |
| G           | Blue - Red                     |
| B           | Purple - Green                 |

5. Green lens adjustment:  
Set the lens at the point where Blue just changes to Red. If the color aberration is irregular throughout the picture screen, adjust the lens to show Red color aberration (approximately 1~3 mm area) within a 3-block grid around the horizontal center-line. If the color aberration is irregular, adjust the lens as shown in the diagram below. (Accurate alignment of Green is important for overall color quality.)
6. Red lens adjustment  
Set the Red lens at the point where Orange becomes Crimson.
7. Blue lens adjustment  
Set the Blue lens at the point where Purple becomes Green.

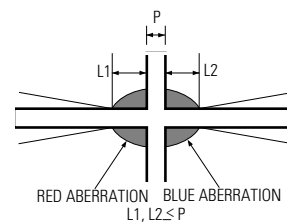
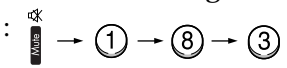
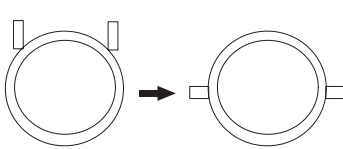

Fig. 4-2 Color Aberration

## 4-5 Beam alignment Adjustments



1. Select the "STANDARD" video mode.
2. Warm up the set at least for 10 minutes.
3. Enter the Convergence mode by pressing the remote control buttons in the following sequence  
 : 
4. Set the Beam Alignment Adjustment CY to Zero magnetic field area.



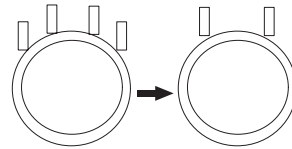

(Creation of CPM Zero Magnet)

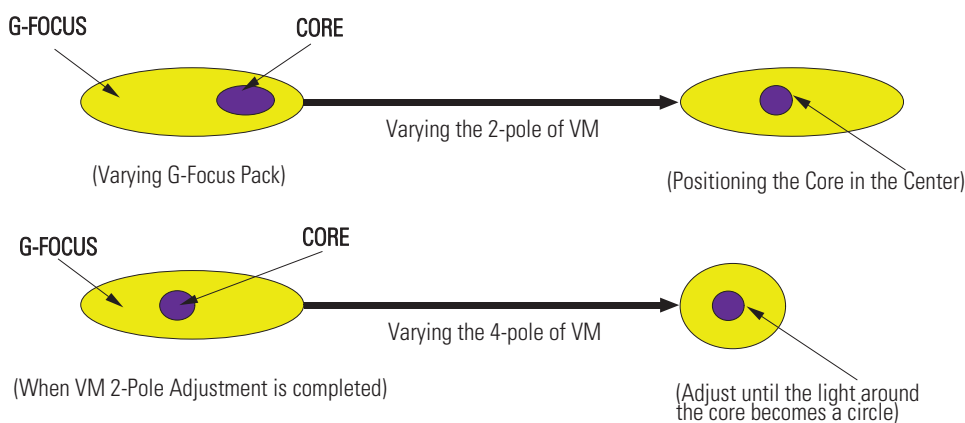

(Creation of the 2-pole/4-pole zero magnets)

5. Check the squarewave at the point where the focus is misaligned (Use an audio oscillator).
6. Press the  button on the remote control, and a vibrating dot-pattern appears.
7. Adjust the Focus-pack VR for defocusing.
8. Mute the other patterns (R/B) other than G-PATTERN.  
 (Use  /  buttons on the remote control.)
9. Adjust the 2, 4 polarities of VM-COIL as shown in figure below.
10. Adjust the G-Focus until any light around the core disappears.



11. Adjust G-Focus so that the surrounding flash can disappear from the spot.
12. After G-Focus adjustments are complete, adjust R-Focus as above procedures.
13. The B-CRT adjustments can be omitted because the variance of beam focus is small.  
 (Only Vm-coil is mounted.)
14. Adjust the Focus-pack VR for fine focusing.
15. Press the  button on the remote control, and the mode changes to the Convergence Adjustment mode.
16. Press the  button on the remote control to return to normal viewing.

## 4-6 High Voltage Part

### 4-6-1 PWM REG Circuit

For the existing high voltage REG circuit (input voltage variation type), a dynamic REG response is not provided. So it is difficult for both beam linearity and uniformity in screen size to be maintained on the screen with rapidly changing beams.

A PWM (Pulse Width Modulation) type of high voltage, however, provides the maintenance of beam linearity and uniformity in screen size via a quick response to beam change by performing sync lock every 1H line, and detecting beam fluctuation at 1H line, and then controlling the IC current of high voltage output circuit.

#### 1. High Voltage Fluctuation Detect (DC Detect)

FBT pin 11 detects DC high voltage fluctuation. The detected DC high voltage value is input to PWM IC471 pin1 through R473, VR471, R471, and then it is input to a differential AMP circuit that differentiates the gap after comparing with the reference voltage input to pin2.

#### 2. High Voltage Fluctuation Detect (AC Detect)

To check AC high voltage fluctuation, the output from FBT is detected by using a capacitor inside the high voltage distributor. The detection of AC high voltage fluctuation, a detection of dynamic beam current change is required in order to keep beam linearity and uniformity in size.

Regarding the capacitor, a capacity of less than 3000P should be applied to a PWM type. (The existing type needs a capacity of about 6000P.) AC detect circuit eliminates unnecessary high frequency by using C476, D472. Also, AC gain is limited to + / - 0.7V (D472). This AC gain is combined with the detection value of DC high voltage fluctuation by using C478.

#### 3. PWM IC OSC Sync Lock

A PWM type IC needs sync lock for PWM pulse and horizontal scan line.

The standard time constant of OSC circuit is determined by C487, R475 (PWM IC pins 5 and 6). And the standard OSC frequency is about 27 kHz. The horizontal frequency of scan line is 31.5kHz(NT), 3375kHz(DTV), 15.75kHz(Interface), so sync lock for this horizontal frequency should be performed using sync lock circuit. The sync lock circuit consists of Q481(Tr KSC815-Y), D479, D478, and C492. The input AFC signal is connected to PWM IC pin 5 through D479 so that it can be negative Trig.

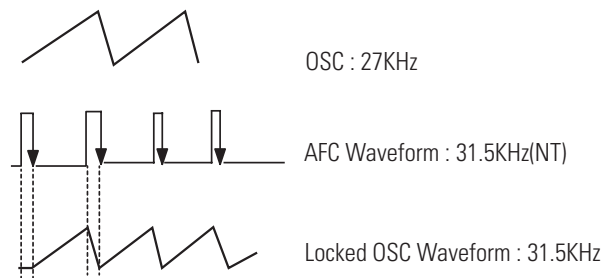

#### 4. Dead Time (HV Protect)

Dead Time (PWM IN pin4) consists of C481, delays high voltage for a certain time to soft start in power on, a x-ray protection circuit. The voltage of Dead Time is detected by FBT pin7 and through DC Feedback. The normal voltage of Dead Time is +27V. When high voltage increases, however, detected voltage is in proportion to high voltage. Then, the detected voltage is applied to ICR01S(TL431). If the voltage is over 2.5V (normal:about 2.25V), TL431 turns ON, the base port of QR401S becomes low, and then an emitter current flows. At this time, a high voltage protection point is set. When QR401S turns ON, high voltage is applied to PWM IC pin4 and then muted.

### 5. Output Circuit

The voltages, which are detected form an error detection circuit of PWM IC (Differential AMP) and Dead Time, each is applied to PWM comparator . Due to these detection coltages, Q1, Q2 (Output TR) parallel operate. Q482 (External TR), however, functions as a buffer; natches impedance between the output port of PWM IC and the final output TR(IRFS640). The PWM pulse (applied to the final output FET (IRFS640 GATE) varies the IC current of high voltage TR(Q473) by adjusting the load impedance of storage Trans (T431). Due to this variation of current, the gain for Q473 emitter pulse changes T444(FBT)makes this emitter pulse became high voltage. Such change keeps both dynamic and static changes fixed. The output waveform of high voltage TR emitter is as shown in the figure below.

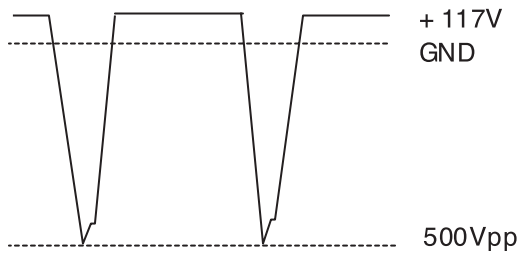

about 1V. A PWM modulation type REG detects static, dynamic high voltage fluctuation for only Ton Time (when the current of the output TR collector flows) each 1H, and modulates the width of PWM pulse. So, this PWM type has better improvement in the characteristic of high voltage REG as compared to the existing type.

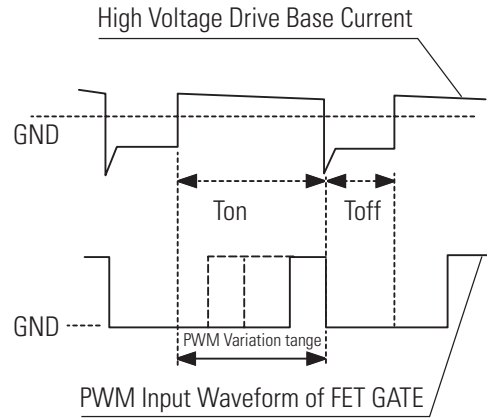

### 8. Application Effects

- 1) Improvement of horizontal size fluctuation
- 2) Linearity improved
- 3) Embodiment of X-ray protection circuit

The figures below show characteristics when a PWM high voltage REG circuit is applied.

### 6. Parameters according to beam

To maintain the set high voltage value (31kV), parmaters such as +Ve (DC), Vcp High Voltage change (See the table below).

| Factor of high voltage change | Parameters              |           |     |              |
|-------------------------------|-------------------------|-----------|-----|--------------|
|                               | Width of FET Gate Pulse | + Ve (DC) | Vcp | High Voltage |
| Beam ↓<br>(High voltage ↑)    | ↓                       | ↑         | ↓   | ↓            |
| Beam ↓<br>(High voltage ↑)    | ↑                       | ↓         | ↑   | ↑            |

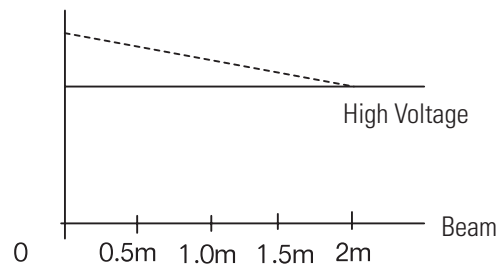

----- High Voltage OFF  
 \_\_\_\_\_ High Voltage REG ON

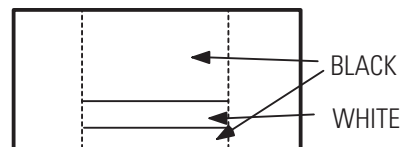

PWM type



Existing type

When a Toshiba Pattern is received, the screen is displayed as shown in figure side

## 4-7 Screen-Jig

### 4-7-1 HCM4215W/HCM422W/HCM4216W (NORMAL MODE)

42W5ScreenSize:X932,Y524(X:378=9\*2+30\*12,Y:440=28\*2+64\*6)

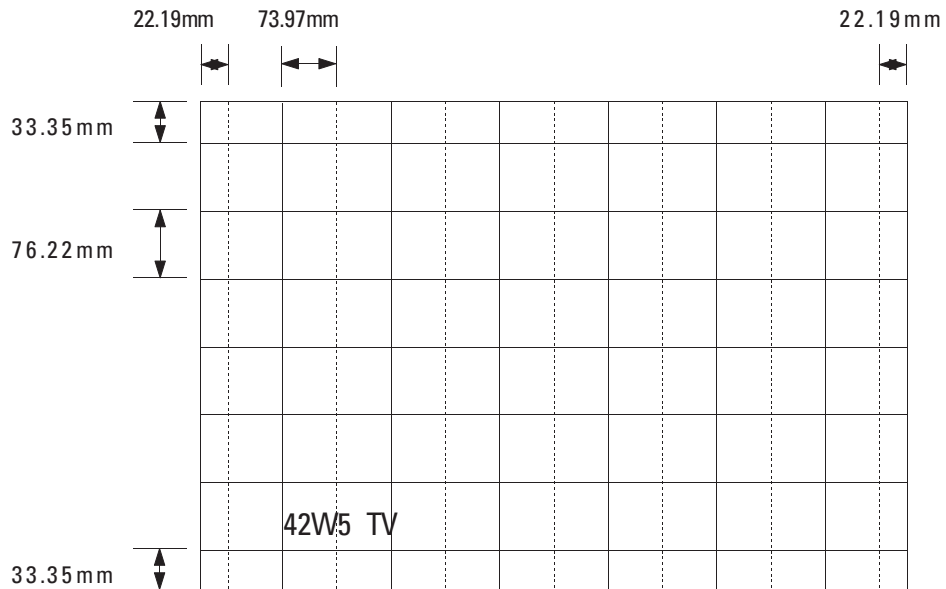

### 4-7-2 HCM4215W/HCM422W/HCM4216W (DTV MODE)

42W5 DTV Mode : X 932, Y 524 (X:408=18\*2+31\*12, Y:488=40\*2+68\*6)

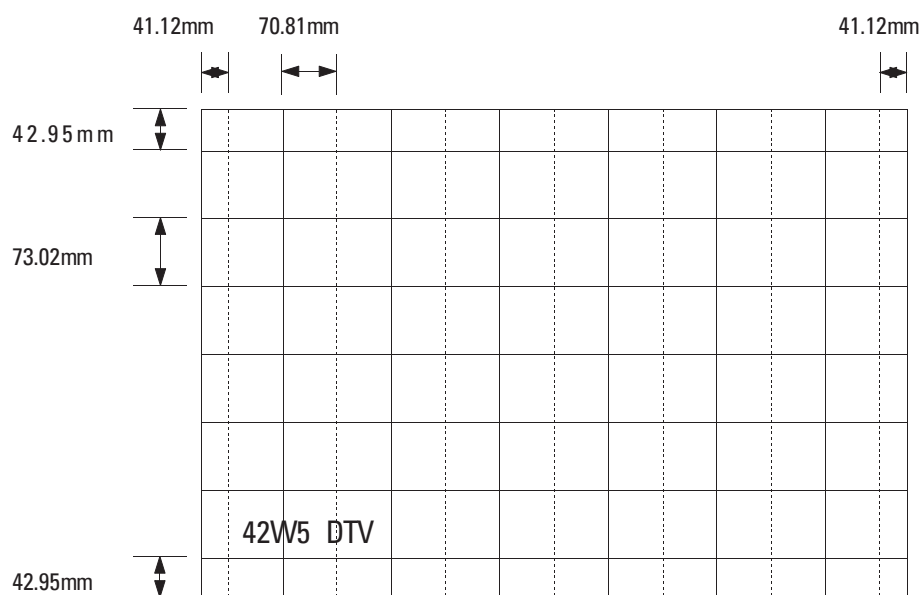



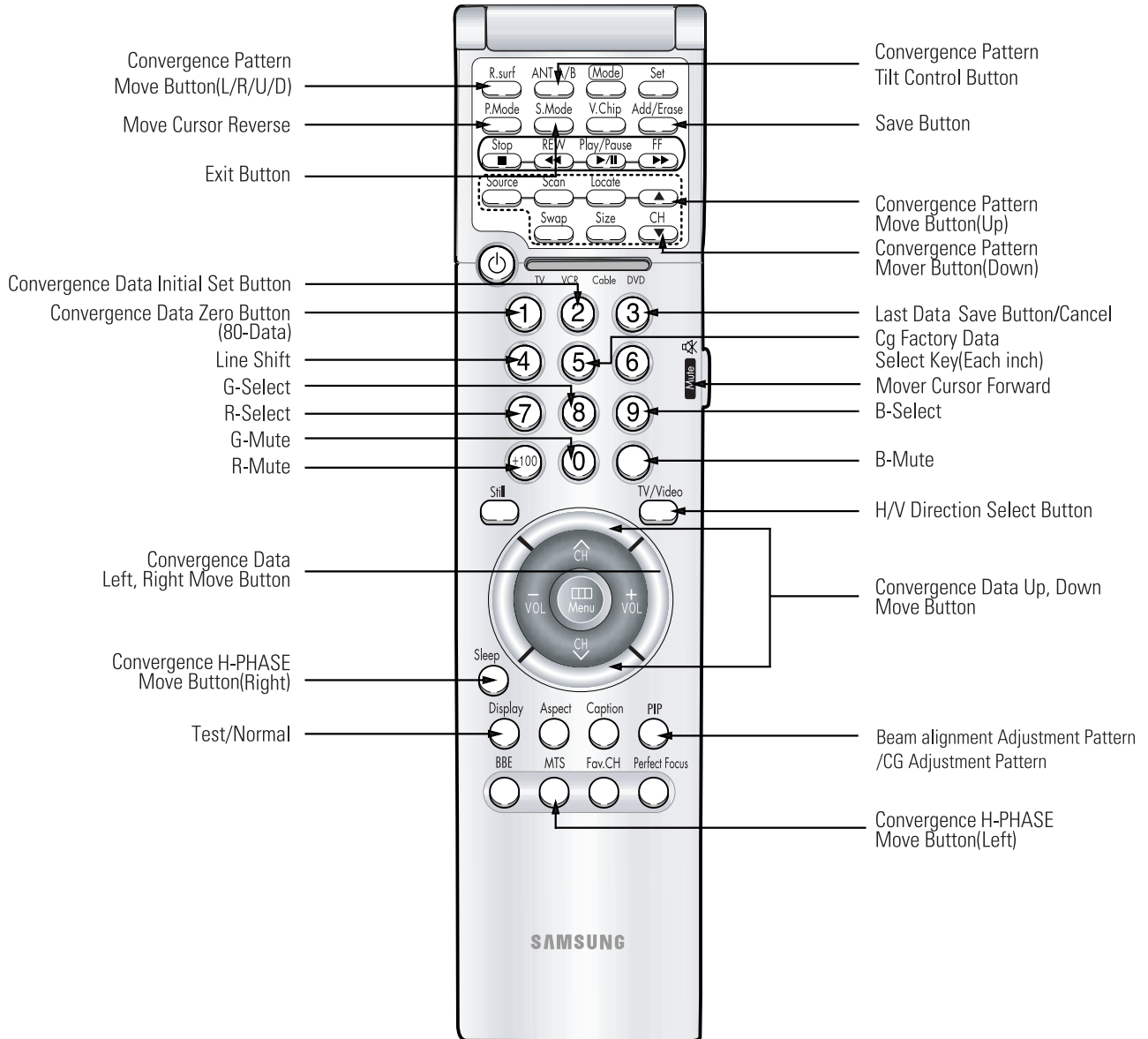











## 4-8 Remote Control for Servicing (Convergence Mode)





### 4-7-1 KEY Function

1. R-SELECT   
Press to select RED color.
2. G-SELECT   
Press to select GREEN color.
3. B-SELECT   
Press to select BLUE color.
4. R-MUTE   
Press to mute RED color.
5. G-MUTE   
Press to mute GREEN color.
6. B-MUTE   
Press to mute BLUE color.
7. CANCEL KEY   
Press to revert to the previous data during the Convergence Adjustment.
8. TEST/NORMAL   
Press to check TV mode in the Convergence Mode.
9. LINE SHIFT   
Press to move a line up/down or left/right.
10. FACTORY DATA SELECT BUTTON   
Press to call the factory default values.
11. H/V DIRECTION SELECT BUTTON   
Press to switch the cursor direction horizontally or vertically.
12. SAVE BUTTON   
After the Convergence Adjustments are completed, press to save data.
13. EXIT BUTTON   
After the Convergence adjustments are completed, press to exit to TV mode.

14. MOVE CURSOR FORWARD   
 Press to move the cursor right or down.

15. MOVE CURSOR REVERSE   
 Press to move the cursor left or up.

16. CONVERGENCE PICTURE MOVE BUTTON

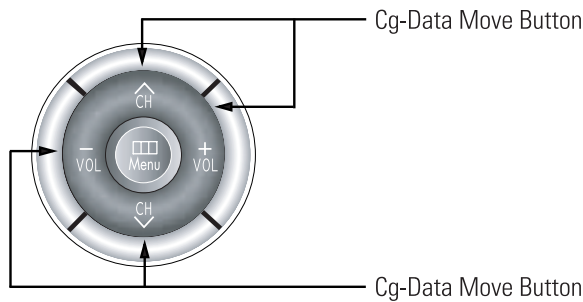

17. CONVERGENCE MOVE BUTTON    
 Press to move the convergence left (  ) or right (  ).

18. CONVERGENCE DATA ZERO BUTTON ①  
 Press to zero the convergence correction data.

19. INITIAL DATA SET BUTTON ②

**Changes when applying Almighty-Cg, Module (How to extract the basic Cg Data)**

| Inch (Type) | Model Name           | Basic Data                        | Screen Display  |
|-------------|----------------------|-----------------------------------|---|
|             | Representative Model | Number after entering the Cg-Mode |   |
| 42"         |                      | 5-425(Press in regular order)     |  |

20. Move Convergence Pattern P55A Service Manual   
 After pressing the R.surf button, use the Channel Up/Down and Volume +/- buttons to move the Convergence Pattern up/down/left/right.

21. Convergence Pattern Tilt Control Button   
 After pressing the ANT A/B button, use the Channel Up/Down and Volume +/- buttons to create a tilt to the Convergence Pattern.

**NOTE** Note : Use the following two buttons only when they are indispensable.

21. Beam alignment Adjustment Pattern achieve Button 

## 4-8 Convergence Adjustment

### 4-8-1 Convergence Adjustment)



#### Special Notes

- / A sensor is attached on the center of each side of the Convergence Mode pattern (see figure below). The sensors are required for normal Perfect Focus function.
- / Use a screen jig to do the convergence adjustments correctly (Especially, perform correct convergence adjustments on the center of each side where a sensor is located.)
- / Do the convergence adjustments correctly. Otherwise, any Perfect Focus error can happen.

1. Warm up the TV for a least 30 minutes.
2. Input an NTSC Signal.(Use an antenna or AV source.)







Make sure that deflection yoke are properly adjusted so that the center of Green, Red, Blue pattern is aligned on the center of screen jig.

3. Enter the Convergence Mode by Pressing the remote control keys in the following sequence:

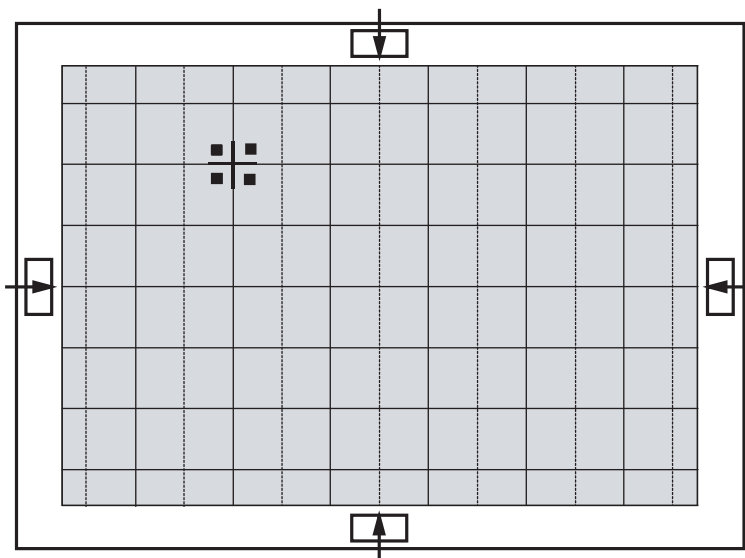

If OSD displayed as shown in figure below, press the  key to exit. Then, redo step 3 to enter the Convergence Mode. After entering the Convergence Mode, Stand by for about five seconds before doing the adjustments.





4. To adjust GREEN, first press the  and the  keys, and then press the  key. Press to move the cursor right or down.

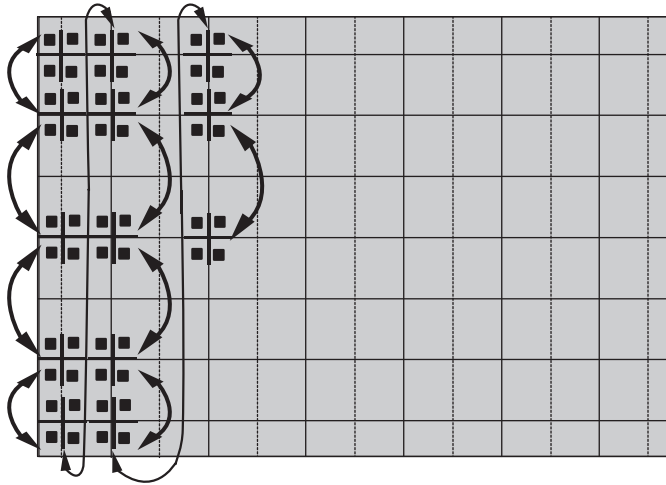

5. The  key moves the cursor horizontally or vertically.



When the  key is pressed once again, the cursor moves horizontally.

6. The  key moves the cursor right, and the  key moves the cursor left.

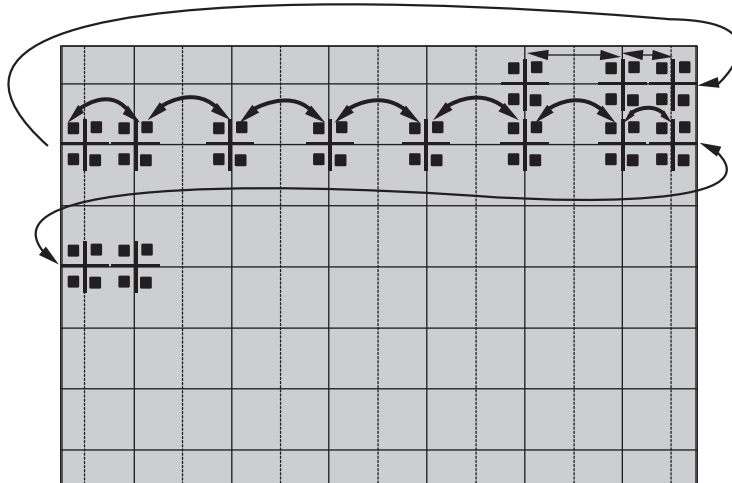

7. Use the ④ key for overall balance.

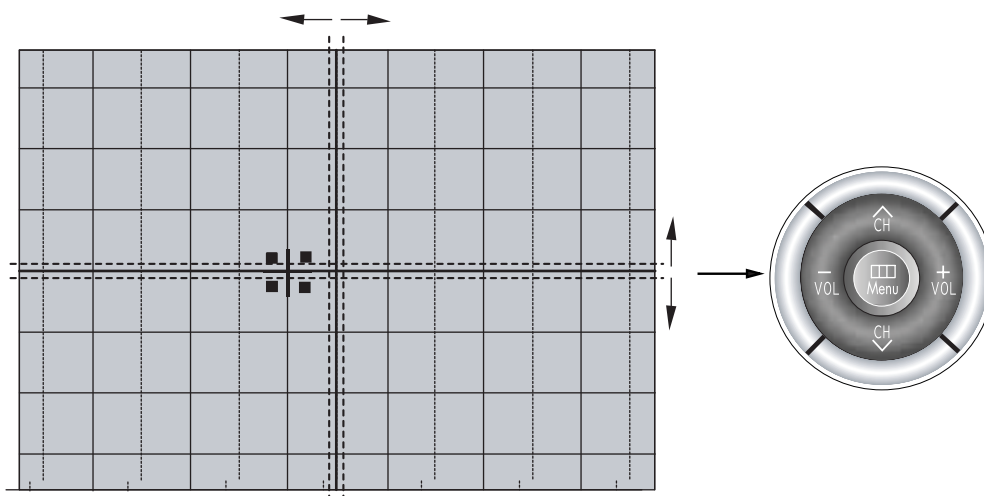

8. After the Line Shift is cancelled by pressing the ④ key, use the Channel and Volume keys (Up/Down) to make big adjustments.



9. After the green convergence adjustments are completed, press the <sup>Add/Erase</sup>  key to save the data.

10. Superimpose the Red and Green colors by pressing the  and the  keys.

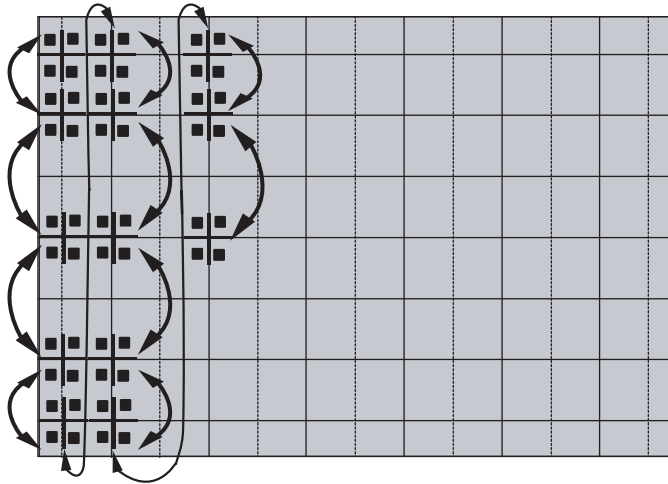
11. To adjust RED, redo steps 5~7.



When the cursor moves vertically 

12. To superimpose the blue and green colors, press (1) the  key for R-Mute, (2) the  key to cancel the B-Mute, and (3) the  key for B- select

13. To adjust BLUE, redo steps 5~7, 13.

14. If any color is not properly adjusted when displaying the red, blue and green colors, readjust the color.



2. After the Convergence Adjustments are complete, press the  key to exit.
3. DTV Convergence adjustment must be done same as the above Normal Mode Convergence Adjustment (Use a 16 : 9 screen jig for DTV)



When Convergence Adjustment is not normally done or the convergence center is misaligned with the sensing point, any adjustment error happens. Therefore, be sure to use a screen jig to correctly adjust during troubleshooting.



## 4-9 MICOM and Pins Voltage

### 4-9-1 MICOM MODULE Pins

| PIN NO | ITEM       | FUNCTION                   | VOLT     |
|--------|------------|----------------------------|----------|
| 1      | KEY 1      | KEY SCAN 1                 | 2.28[V]  |
| 2      | PROTECT    | PROTECT PORT               | 0.83[mV] |
| 3      | KEY 2      | KEY SCAN 2                 | 2.25[V]  |
| 4      | GND        | GND                        | -        |
| 5      | KEY 3      | KEY SCAN 3                 | 2.29[V]  |
| 6      | STB-5[V]   | VCC                        | 4.91[V]  |
| 7      | IR IN      | REMOCON INPUT              | 3.74[V]  |
| 8      | POWER      | POWER ON/OFF RELAY CONTROL | 1.03[V]  |
| 9      | TIMER-LED  | TIMER LED                  | 2.07[V]  |
| 10     | 1080 i     | 1080i MODE SWITCHING       | 2.53[V]  |
| 11     | GND        | GND                        | -        |
| 12     | V-RESET    | VIDEO SIGNAL MUTE          | 2.84[mV] |
| 13     | SCL1       | SERIAL CLOCK LINE 1        | 3.43[V]  |
| 14     | GND        | GND                        | -        |
| 15     | SDA1       | SERIAL DATA LINE 1         | 3.49[V]  |
| 16     | S-RESET    | SOUND RESET                | 4.21[V]  |
| 17     | ST-BY-LED  | STANDY-BY LED              | 2.95[V]  |
| 18     | RESET      | RESET                      | 2.47[V]  |
| 19     | AMP-MUTE   | SOUND AMP MUTE             | 0.89[mV] |
| 20     | N.C        | N.C                        | -        |
| 21     | GND        | GND                        | -        |
| 22     | SW1        | SW1 (CONTROL)              | 4.58[V]  |
| 23     | SCL2       | SERIAL CLOCK LINE 2        | 3.27[V]  |
| 24     | C-SPK-MUTE | CENTER SPEAKER MUTE        | 3.26[V]  |
| 25     | SDA2       | SERIAL DATA LINE 2         | 3.27[V]  |
| 26     | SW3        | SW3 (CONTROL)              | 5[mV]    |
| 27     | GND        | GND                        | -        |
| 28     | SW2        | SW2 (CONTROL)              | 2.08[V]  |
| 29     | SUB-AFT    | SUB AFT CONTROL            | 2.57[V]  |
| 30     | GND        | GND                        | -        |
| 31     | MAIN-AFT   | MAIN TUNER AFT CONTROL     | 1.04[V]  |
| 32     | BUS-STOP   | I <sup>2</sup> C BUS STOP  | 3.27[V]  |

|    | ITEM       | FUNCTION                | VOLT       |
|----|------------|-------------------------|------------|
| 33 | 5[V]       | 5[V]                    | 4.96[V]    |
| 34 | J-BLANK    | HORIZONTAL BLANK        | 215.8[mV]  |
| 35 | GND        | GND                     | -          |
| 36 | V-BLANK    | VERTICAL BLANK          | -12.10[mV] |
| 37 | 2RF-S      | 2RF-SWITCHING           | 297.68[mV] |
| 38 | GND        | GND                     | -          |
| 39 | GND        | GND                     | -          |
| 40 | N.C        | N.C                     | -          |
| 41 | VS1        | VERTICAL SYNC           | -          |
| 42 | N.C        | N.C                     | -          |
| 43 | HS1        | HORIZONTAL SYNC         | 215.51[mV] |
| 44 | N.C        | N.C                     | -          |
| 45 | GND        | GND                     | -          |
| 46 | S-SW1      | SUB TUNER SWITCH 1      | 3.74[V]    |
| 47 | TTX-CVBS   | TTX/CAPTION-CVBS        | 1.19[V]    |
| 48 | GND        | GND                     | -          |
| 49 | GND        | GND                     | -          |
| 50 | S-SW2      | SUB TUNER SWITCH 2      | -          |
| 51 | AV-LINK    | NOT USE                 | -          |
| 52 | M-SW1      | MAIN TUNER SWITCH 1     | -          |
| 53 | GND        | GND                     | -          |
| 54 | M-SW2      | MAIN TUNER SWITCH 2     | -          |
| 55 | RXD        | RXD                     | -          |
| 56 | GND        | GND                     | -          |
| 57 | TXD        | TXD                     | -          |
| 58 | OSD-TTX-R  | ON SCREEN DISPLAY RED   | 168[mV]    |
| 59 | GND        | GND                     | -          |
| 60 | OSD-TTX-G  | ON SCREEN DISPLAY GREEN | 0.46[V]    |
| 61 | WP         | WRITE PROTECT           | -          |
| 62 | OSD-TTX-B  | ON SCREEN DISPLAY BLUE  | 0.46[V]    |
| 63 | 3.3[V]     | 3.3[V]                  | 3.26[V]    |
| 64 | OSD-TTX-FB | OSD/TTX-FB              | 7.31[mV]   |

**4-9-2 PROSCAN MODULE Pins**

| PIN NO | ITEM       | FUNCTION                         | VOLT       |
|--------|------------|----------------------------------|------------|
| 1      | EW         | EAST WEST OUT                    | 2.26[V]    |
| 2      | V-BLK      | VERTICAL BLANK                   | -12.07[mV] |
| 3      | ABL        | ABL(Automtic Brightness Limiter) | 2.26[V]    |
| 4      | VD-        | VERTICAL DRIVE (- VOLTAGE)       | 3.46[V]    |
| 5      | VD+        | VERTICAL DRIVE (+ VOLTAGE)       | 3.53[V]    |
| 6      | H-BLK      | HORIZONTAL BLANKING              | 215.93[mV] |
| 7      | HD         | HORIZONTAL DRIVE                 | 2.38[V]    |
| 8      | GND        | GND                              | -          |
| 9      | OSD/TTX-FB | OSD/TTX-FB                       | 7.29[mV]   |
| 10     | OSD/TTX-B  | ON SCREEN DISPLAY BLUE IN        | 0.46[mV]   |
| 11     | OSD/TTX-G  | ON SCREEN DISPLAY GREEN IN       | 0.46[mV]   |
| 12     | OSD/TTX-R  | ON SCREEN DISPLAY RED IN         | 167.99[mV] |
| 13     | V-RESET    | VIDEO SIGNAL MUTE                | 2.94[mV]   |
| 14     | GND        | GND                              | -          |
| 15     | SCL1       | SERIAL CLOCK LINE                | 3.42[V]    |
| 16     | SDA1       | SERIAL DATA LINE                 | 3.50[V]    |
| 17     | HS1        | HORIZONTAL SYNC                  | 251.4[mV]  |
| 18     | VS1        | VERTICLA OUT                     | 27.28[mV]  |
| 19     | GND        | GND                              | -          |
| 20     | CG-R       | CONVERGENCE RED                  | 0.27[mV]   |
| 21     | CG-G       | CONVERGENCE GREEN                | 0.27[mV]   |
| 22     | CG-B       | CONVERGENCE BLUE                 | 0.29[mV]   |
| 23     | CG-SYNC    | CONVERGENCE SYNC                 | 180.03[mV] |
| 24     | D/F        | DYNAMIC FOCUS                    | 1.5[V]     |
| 25     | GND        | GND                              | -          |
| 26     | 9[V]       | 9[V]                             | 9[V]       |
| 27     | GND        | GND                              | -          |
| 28     | N.C        | N.C                              | -          |
| 29     | RXD        | RXD                              | -          |
| 30     | TXD        | TXD                              | -          |
| 31     | GND        | GND                              | -          |
| 32     | 13.5[V]    | 13.5[V]                          | 14.05[V]   |

|    | ITEM          | FUNCTION              | VOLT     |
|----|---------------|-----------------------|----------|
| 33 | 5[V]-DW1      | 5[V]-DW1              | 4.97[V]  |
| 34 | VM-Y          | VM-Y OUTPUT           | 1.97[V]  |
| 35 | SW3           | SW3 (CONTROL)         | 4.98[mV] |
| 36 | SW2           | SW2 (CONTROL)         | 2.08[V]  |
| 37 | SW1           | SW1 (CONTROL)         | 4.58[V]  |
| 38 | GND           | GND                   | -        |
| 39 | PIP-C         | PIP-C INPUT           | 1.20[mV] |
| 40 | PIP-Y/C CVBS  | PIP-Y/CVBS INPUT      | 1.33[mV] |
| 41 | GND           | GND                   | -        |
| 42 | MAIN-C        | MAIN-C INPUT          | 1.34[mV] |
| 43 | MAIN-Y/C CVBS | MAIN-Y/CVBS INPIUT    | 1.57[mV] |
| 44 | N.C           | N.C                   | -        |
| 45 | GND           | GND                   | -        |
| 46 | N.C           | N.C                   | -        |
| 47 | GND           | GND                   | -        |
| 48 | RF2-CVBS      | RF1-CVBS              | -        |
| 49 | DVD-Pr/R      | DVD-Pr/R (COMPONENT1) | -        |
| 50 | DVD-Y/G       | DVD-Y/G (COMPONENT1)  | -        |
| 51 | DVD-Pb/R      | DVD-Pr/B (COMPONENT1) | -        |
| 52 | FB            | NOT USE               | -        |
| 53 | GND           | GND                   | -        |
| 54 | DTV1-Pr       | DTV1-Pr (COMPONENT3)  | -        |
| 55 | DTV1-Y        | DTV1-Y (COMPONENT3)   | -        |
| 56 | DTV1-Pb       | DTV1Pb (COMPONENT3)   | -        |
| 57 | GND           | GND                   | -        |
| 58 | DTV2-Pr       | DTV2-Pr (COMPONENT3)  | -        |
| 59 | DTV2-Y        | DTV2-Y (COMPONENT3)   | -        |
| 60 | DTV2-Pb       | DTV2-Pb (COMPONENT3)  | -        |
| 61 | GND           | GND                   | -        |
| 62 | 5[V]-DW2      | 5[V]-DW2              | 4.89[V]  |
| 63 | DVI-ID        | N.C                   | -        |
| 64 | PC-ID         | N.C                   | -        |

**4-9-3 CONVERGENCE MODULE Pins**

| PIN NO | ITEM    | FUNCTION             | VOLT        |
|--------|---------|----------------------|-------------|
| 1      | 5[V]-CG | 5[V]-CG              | 5.2[V]      |
| 2      | GND     | GND                  | -           |
| 3      | D/F     | DYNAMIC FOCUS        | 1.5[V]      |
| 4      | GND     | GND                  | -           |
| 5      | SCL1    | SERIAL CLOCK LINE 1  | 3.4[V]      |
| 6      | CG-SYNC | CONVERGENCE SYNC     | 179[mV]     |
| 7      | GND     | GND                  | -           |
| 8      | N.C     | N.C                  | 5.2[V]      |
| 9      | CG-R    | CONVERGENCE RED      | 0.27[mV]    |
| 10     | CG-G    | CONVERGENCE GREEN    | 0.26[mV]    |
| 11     | CG-B    | CONVERGENCE BLUE     | 0.29[mV]    |
| 12     | SDA1    | SERIAL DATA LINE 1   | 3.5[V]      |
| 13     | N.C     | N.C                  | -           |
| 14     | IR      | INPUT REMOCON        | 3.7[V]      |
| 15     | N.C     | N.C                  | -           |
| 16     | GND     | GND                  | -           |
| 17     | GND     | GND                  | -           |
| 18     | GND     | GND                  | -           |
| 19     | BV      | BULE VERTICAL OUT    | 34.27[mV]   |
| 20     | BH      | BULE HORIZONTAL OUT  | -107.32[mV] |
| 21     | GV      | GREEN VERTICAL OUT   | 101.52[mV]  |
| 22     | GH      | GREEN HORIZONTAL OUT | -15.83[mV]  |
| 23     | RV      | RED VERTICAL OUT     | 104.32[mV]  |
| 24     | RH      | RED HORIZONTAL OUT   | -88.95[mV]  |
| 25     | GND     | GND                  | -           |
| 26     | H-BLK   | HORIZONTAL BLANK     | 275[mV]     |
| 27     | V-BLK   | VERTICAL BLANK       | -13.22[mV]  |
| 28     | GND     | GND                  | -           |
| 29     | N.C     | N.C                  | -           |
| 30     | -5[V]   | -5[V]                | -4.99[V]    |
| 31     | 5[V]    | 5[V]                 | 5.24[V]     |
| 32     | GND     | GND                  | -           |

# MEMO

## 5. Troubleshooting

### 5-1 Convergence Misaligned

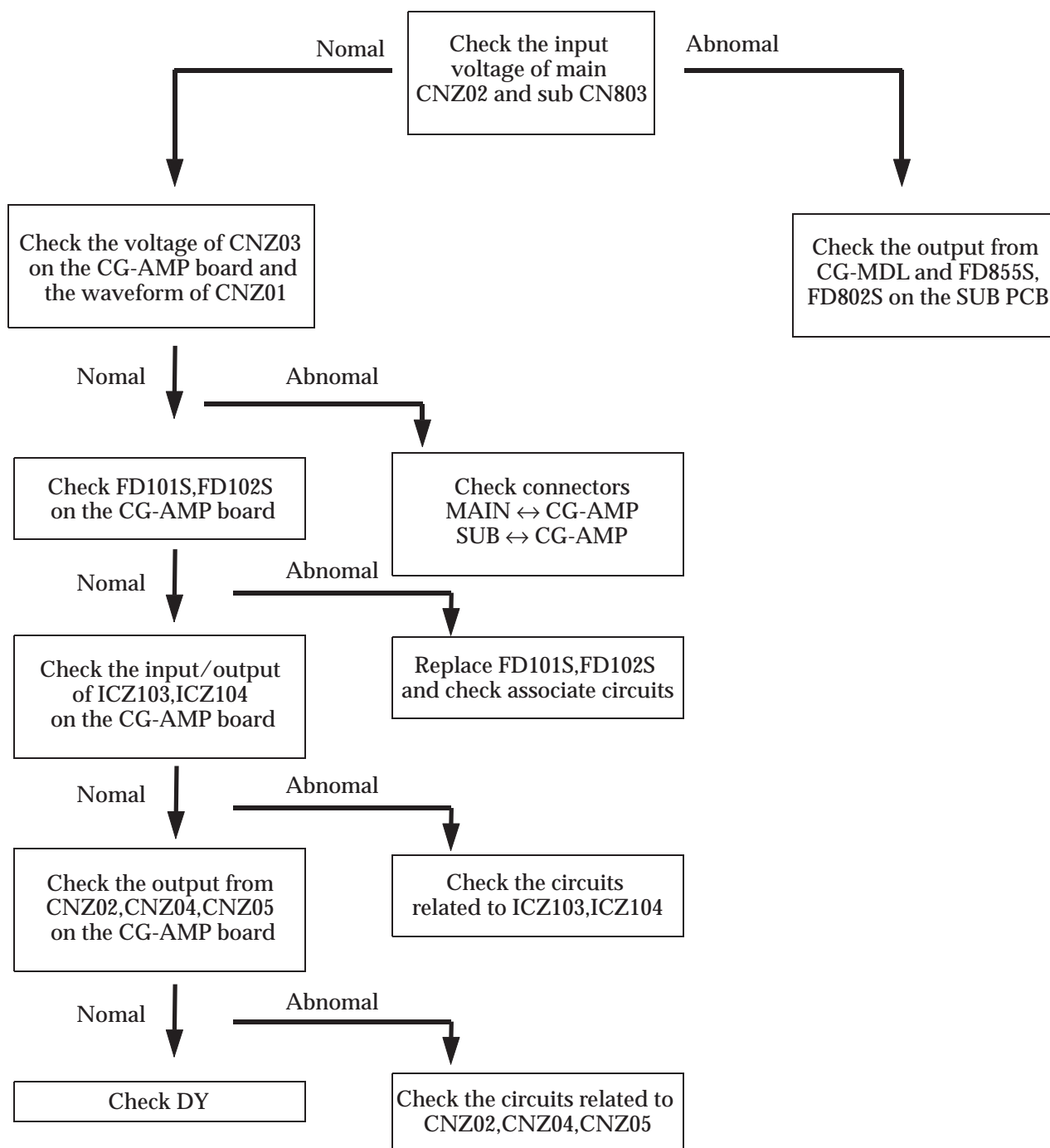

## 5-2 No Sound

---

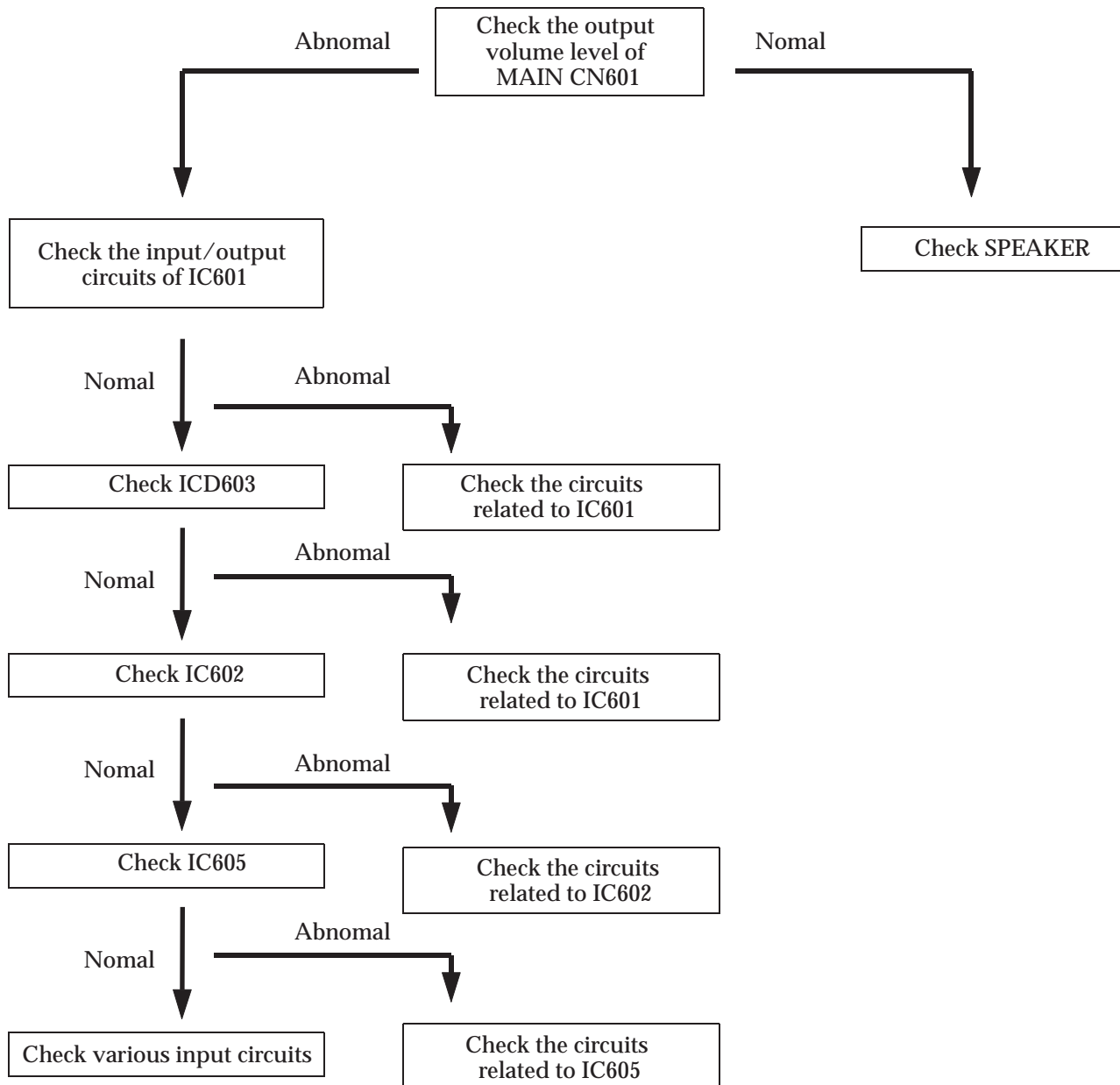



## 5-3 No Raster

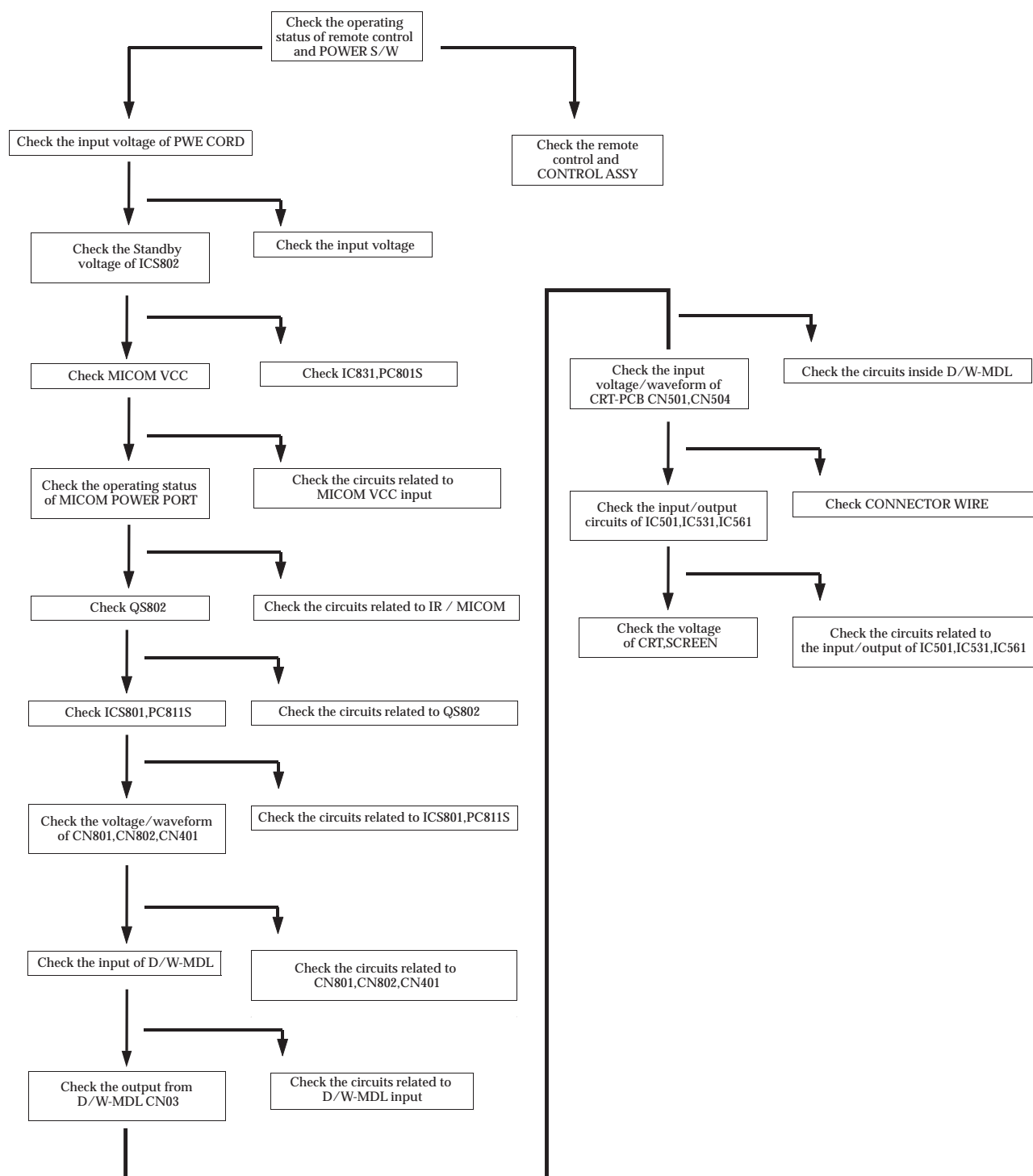

# MEMO

## 6. Exploded View & Parts List

### 6-1 HCM4215WX/XAA

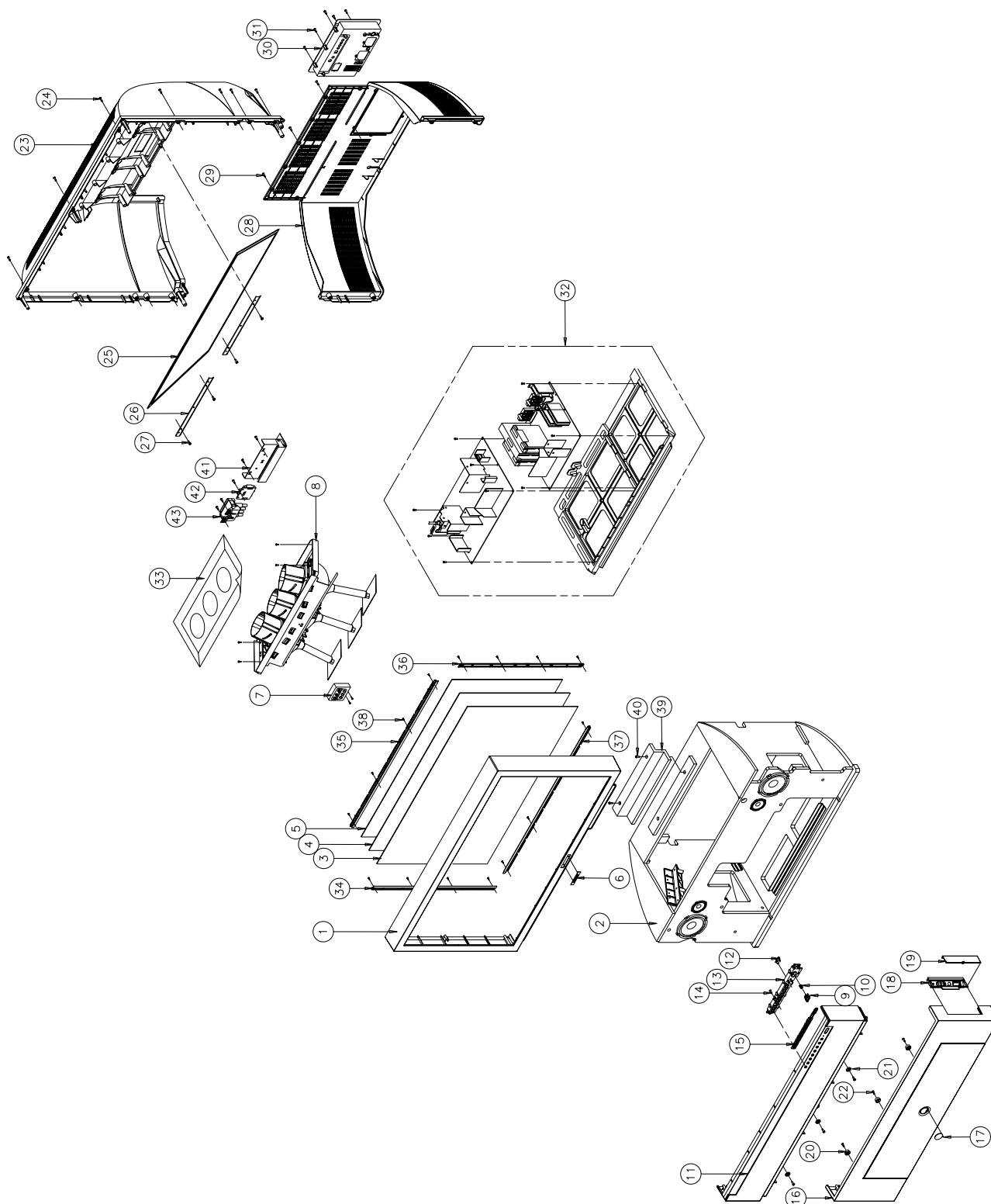

**6-2 HCM4215WX/XAA**

| No | Code No     | Description;Specification                | Q'ty | Remark | S.N.A |
|----|-------------|--|------|--------|-------|
| 1  | AA64-02727D | CABINET-FRONT,MASK TOP;42W5,HIPS,HB,G430 | 1    |        | S.N.A |
| 2  | BP91-00005D | ASSY-CABINET,WOOD;;WOOD,MIJU,42W5        | 1    |        | S.N.A |
| 3  | AA67-00207A | SCREEN-FILTER;;T=82%,960*552*2,G=110,AG  | 1    |        |       |
| 4  | AA67-00193A | SCREEN-TINT;42W,958*550,T=0.73,P=052     | 1    |        |       |
| 5  | AA67-00193B | SCREEN-FRESNEL;42W,960*552,T=2.0         | 1    |        |       |
| 6  | AA64-02211D | BADGE-BRAND;72MM,AL FORGING,DG703P,SAMSU | 1    |        | S.N.A |
| 7  | BP59-00005A | MODULE-FOCUS PACK ASS'Y;PJT TV,F301-P03A | 1    |        |       |
| 8  | BP91-00259A | ASSY PRT;HCM4215WX/XAA,P55A,ASSY-PRT     | 1    |        | S.N.A |
| 9  | AA64-02740B | KNOB-POWER;42W5,ABS,HB,G3676,SVM3012     | 1    |        |       |
| 10 | AA61-60003J | SPRING-CS;-SUS304,-,-,OD6,N7,OD6,-,-,-,  | 1    |        | S.N.A |
| 11 | AA64-02726B | CABINET-PANEL CONTROL;42W5,HIPS,HB,G4309 | 1    |        | S.N.A |
| 12 | AA64-02742A | WINDOW-RMC,LED;42W5,PC,CLR               | 1    |        | S.N.A |
| 13 | AA64-02739B | KNOB-CONTROL;42W5,ABS,HB,G3676,SVM3012   | 1    |        |       |
| 14 | 6003-001026 | SCREW-TAPTITE;RH,+,B,M4,L15,ZPC(BLK),SWR | 4    | KC+CPC |       |
| 15 | AA61-01130B | GUIDE-KNOB,CONTROL;42W5,ABS HB,G3676,SVM | 1    |        | S.N.A |
| 16 | AA64-02725G | CABINET-FRONT,BOT;42W5,HIPS,VO,G4309,DG7 | 1    |        | S.N.A |
| 17 | AA64-02743B | BADGE-DECORATION;42W5,AL,DG703P,NI,RS    | 1    |        | S.N.A |
| 18 | AA61-01128F | HOLDER-SIDE,A/V;42W5,ABS HB,G3676,DG703P | 1    |        | S.N.A |
| 19 | AA64-02780F | DOOR-AV;42W5,ABS HB,G3676,DG703P         | 1    |        |       |
| 20 | AA61-01132A | VELCRO-A;COMMANDO,BST1 1/4H              | 3    |        | S.N.A |
| 21 | AA61-01133A | VELCRO-B;COMMANDO,BST1 1/4H              | 3    |        | S.N.A |
| 22 | 6003-001019 | SCREW-TAPTITE;RH,+,B,M4,L12,ZPC(BLK),SWR | 4    | VC+CPC | S.N.A |
| 23 | AA64-02728A | CABINET-BACK, TOP;42W5,HIPS,HB,G4309     | 1    |        |       |
| 24 | 6003-001026 | SCREW-TAPTITE;RH,+,B,M4,L15,ZPC(BLK),SWR | 11   | CBT+CF |       |
| 25 | AA67-00204A | MIRROR-FRONT;42W5,FSM,870*633*446        | 1    |        |       |
| 26 | BP61-00008A | BRACKET-MIRROR,ASSY;42W5,SECC,T1.0,01123 | 2    |        | S.N.A |
| 27 | 6003-001026 | SCREW-TAPTITE;RH,+,B,M4,L15,ZPC(BLK),SWR | 4    | BM+CBT |       |
| 28 | AA64-02729B | CABINET-BACK,BOT;42W5,HIPS,VO,G4309      | 1    |        |       |
| 29 | 6005-001003 | SCREW-WOOD;HH,+,M4,L19,ZPC(BLK),SWRCH18A | 3    | HC+CW  |       |
| 30 | BP96-00038A | ASSY COVER P-TERMINAL,ANT;42W5,HIPS VO,B | 1    |        | S.N.A |
| 31 | 6003-001026 | SCREW-TAPTITE;RH,+,B,M4,L15,ZPC(BLK),SWR | 4    | TB+RJK |       |
| 32 | BP91-00231A | ASSY CHASSIS;HCM4215WX/MVT,P55A          | 1    |        | S.N.A |
| 33 | AA60-00072B | SPACER-COVER,DUST;43,54,62J9,SPONGE 94HF | 1    |        | S.N.A |
| 34 | BP61-00025B | BRACKET-SCREEN,ASSY(R);42W5,SECC,T1.0,NE | 1    |        | S.N.A |
| 35 | BP61-00023B | BRACKET-SCREEN,ASSY(TOP);42W5,SECC,T1.0, | 1    |        | S.N.A |
| 36 | BP61-00026B | BRACKET-SCREEN,ASSY(L);42W5,SECC,T1.0,NE | 1    |        | S.N.A |
| 37 | BP61-00024B | BRACKET-SCREEN,ASSY(BOT);42W5,SECC,T1.0, | 1    |        | S.N.A |
| 38 | AA60-10011A | SCREW-TAPTITE;-SWRCH18A,M4,L12,HH,+,PC,  | 20   | BS+CF  | S.N.A |
| 39 | BP64-00029A | INLAY-SUPPORT;42W5,PS SHEET,T0.5,94V0    | 1    |        | S.N.A |
| 40 | 6005-001003 | SCREW-WOOD;HH,+,M4,L19,ZPC(BLK),SWRCH18A | 2    | IS+CW  |       |
| 41 | AA95-02002A | ASSY SUB-PCB,CG AMP;COMMANDO             | 1    |        |       |
| 42 | AA94-08270A | ASSY PCB MISC-DY JACK;COMMANDO           | 1    |        | S.N.A |
| 43 | AA26-00101A | TRANS FBT;FWZ50A001E/FFA97513B,12KV,5P,- | 1    |        |       |

## 6-3 HCM4216WX/XAA

| No | Code No     | Description;Specification                | Q'ty | Remark | S.N.A |
|----|-------------|--|------|--------|-------|
| 1  | AA64-02727E | CABINET-FRONT,MASK TOP;42W5,HIPS,HB,G430 | 1    |        |       |
| 2  | BP91-00005D | ASSY-CABINET,WOOD;WOOD,MIJU,42W5         | 1    |        | S.N.A |
| 3  | AA67-00207A | SCREEN-FILTER;;T=82%,960*552*2,G=110,AG  | 1    |        |       |
| 4  | AA67-00193A | SCREEN-TINT;42W,958*550,T=0.73,P=052     | 1    |        |       |
| 5  | AA67-00193B | SCREEN-FRESNEL;42W,960*552,T=2.0         | 1    |        |       |
| 6  | AA64-02211E | BADGE-BRAND;72MM,AL FORGING,SVM1132,SAMS | 1    |        | S.N.A |
| 7  | BP59-00005A | MODULE-FOCUS PACK ASS'Y;PJT TV,F301-P03A | 1    |        |       |
| 8  | BP91-00259A | ASSY PRT;HCM4215WX/XAA,P55A,ASSY-PRT     | 1    |        | S.N.A |
| 9  | AA64-02740A | KNOB-POWER;42W5,ABS,HB,G3676,COT         | 1    |        |       |
| 10 | AA61-60003J | SPRING-CS;-SUS304,-,OD6,N7,OD6,-,-,-,    | 1    |        | S.N.A |
| 11 | AA64-02726A | CABINET-PANEL,CONTROL;42W5,HIPS,HB,G4309 | 1    |        | S.N.A |
| 12 | AA64-02742A | WINDOW-RMC,LED;42W5,PC,CLR               | 1    |        | S.N.A |
| 13 | AA64-02739A | KNOB-CONTROL;42W5,ABS,HB,G3676,COT       | 1    |        |       |
| 14 | 6003-001026 | SCREW-TAPTITE;RH,+,B,M4,L15,ZPC(BLK),SWR | 4    | KC+CPC |       |
| 15 | AA61-01130A | GUIDE-KNOB,CONTROL;42W5,ABS HB,G3676,SVM | 1    |        | S.N.A |
| 16 | AA64-02725F | CABINET-FRONT,BOT;42W5,HIPS,VO,G4309,SVM | 1    |        | S.N.A |
| 17 | AA64-02743A | BADGE-DECORATION;42W5,AL,NI,RS           | 1    |        |       |
| 18 | AA61-01128B | HOLDER-SIDE,A/V;43T7,ABS HB,G3676,SVM-11 | 1    |        | S.N.A |
| 19 | AA64-02780B | DOOR-AV;43T7,ABS HB,G3676,SVM-1132       | 1    |        |       |
| 20 | AA61-01132A | VELCRO-A;COMMANDO,BST1 1/4H              | 3    |        | S.N.A |
| 21 | AA61-01133A | VELCRO-B;COMMANDO,BST1 1/4H              | 3    |        | S.N.A |
| 22 | 6003-001019 | SCREW-TAPTITE;RH,+,B,M4,L12,ZPC(BLK),SWR | 4    | VC+CPC | S.N.A |
| 23 | AA64-02728A | CABINET-BACK,TOP;42W5,HIPS,HB,G4309      | 1    |        |       |
| 24 | 6003-001026 | SCREW-TAPTITE;RH,+,B,M4,L15,ZPC(BLK),SWR | 11   | CBT+CF |       |
| 25 | AA67-00204A | MIRROR-FRONT;42W5,FSM,870*633*446        | 1    |        |       |
| 26 | BP61-00008A | BRACKET-MIRROR,ASSY;42W5,SECC,T1.0,01123 | 2    |        | S.N.A |
| 27 | 6003-001026 | SCREW-TAPTITE;RH,+,B,M4,L15,ZPC(BLK),SWR | 4    | BM+CBT |       |
| 28 | AA64-02729B | CABINET-BACK,BOT;42W5,HIPS,VO,G4309      | 1    |        |       |
| 29 | 6005-001003 | SCREW-WOOD;HH,+,M4,L19,ZPC(BLK),SWRCH18A | 3    | HC+CW  |       |
| 30 | BP96-00038A | ASSY COVER P-TERMINAL,ANT;42W5,HIPS VO,B | 1    |        | S.N.A |
| 31 | 6003-001026 | SCREW-TAPTITE;RH,+,B,M4,L15,ZPC(BLK),SWR | 4    | TB+RJK |       |
| 32 | BP91-00266A | ASSY CHASSIS;HCM4216WX/XAA,P55A,CHASSIS  | 1    |        |       |
| 33 | AA60-00072B | SPACER-COVER,DUST;43,54,62J9,SPONGE 94HF | 1    |        | S.N.A |
| 34 | BP61-00025B | BRACKET-SCREEN,ASSY(R);42W5,SECC,T1.0,NE | 1    |        | S.N.A |
| 35 | BP61-00023B | BRACKET-SCREEN,ASSY(TOP);42W5,SECC,T1.0, | 1    |        | S.N.A |
| 36 | BP61-00026B | BRACKET-SCREEN,ASSY(L);42W5,SECC,T1.0,NE | 1    |        | S.N.A |
| 37 | BP61-00024B | BRACKET-SCREEN,ASSY(BOT);42W5,SECC,T1.0, | 1    |        | S.N.A |
| 38 | AA60-10011A | SCREW-TAPTITE;-SWRCH18A,M4,L12,HH,+,PC,  | 20   | BS+CF  | S.N.A |
| 39 | BP64-00029A | INLAY-SUPPORT;42W5,PS SHEET,T0.5,94V0    | 1    |        | S.N.A |
| 40 | 6005-001003 | SCREW-WOOD;HH,+,M4,L19,ZPC(BLK),SWRCH18A | 2    | IS+CW  |       |
| 41 | AA95-02002A | ASSY SUB-PCB,CG AMP;COMMANDO             | 1    |        |       |
| 42 | AA94-08270A | ASSY PCB MISC-DY JACK;COMMANDO           | 1    |        | S.N.A |
| 43 | AA26-00101A | TRANS FBT;FWZ50A001E/FFA97513B,12KV,5P,- | 1    |        |       |

**6-4 HCM422WX/XAA**

| No | Code No     | Description;Specification                | Q'ty | Remark | S.N.A |
|----|-------------|--|------|--------|-------|
| 1  | AA64-02727F | CABINET-FRONT,MASK TOP;42W5,HIPS,HB,G430 | 1    |        |       |
| 2  | BP91-00005D | ASSY-CABINET,WOOD;WOOD,MIJU,42W5         | 1    |        | S.N.A |
| 3  | AA67-00207A | SCREEN-FILTER;;T=82%,960*552*2,G=110,AG  | 1    |        |       |
| 4  | AA67-00193A | SCREEN-TINT;42W,958*550,T=0.73,P=052     | 1    |        |       |
| 5  | AA67-00193B | SCREEN-FRESNEL;42W,960*552,T=2.0         | 1    |        |       |
| 6  | AA64-02211E | BADGE-BRAND;72MM,AL FORGING,SVM1132,SAMS | 1    |        | S.N.A |
| 7  | BP59-00005A | MODULE-FOCUS PACK ASS'Y;PJT TV,F301-P03A | 1    |        |       |
| 8  | BP91-00259A | ASSY PRT;HCM4215WX/XAA,P55A,ASSY-PRT     | 1    |        | S.N.A |
| 9  | AA64-02740A | KNOB-POWER;42W5,ABS,HB,G3676,COT         | 1    |        |       |
| 10 | AA61-60003J | SPRING-CS;-SUS304,-,-,OD6,N7,OD6,-,-,-,  | 1    |        | S.N.A |
| 11 | AA64-02726A | CABINET-PANEL,CONTROL;42W5,HIPS,HB,G4309 | 1    |        | S.N.A |
| 12 | AA64-02742A | WINDOW-RMC,LED;42W5,PC,CLR               | 1    |        | S.N.A |
| 13 | AA64-02739A | KNOB-CONTROL;42W5,ABS,HB,G3676,COT       | 1    |        |       |
| 14 | 6003-001026 | SCREW-TAPTITE;RH,+,B,M4,L15,ZPC(BLK),SWR | 4    | KC+CPC |       |
| 15 | AA61-01130A | GUIDE-KNOB,CONTROL;42W5,ABS HB,G3676,SVM | 1    |        | S.N.A |
| 16 | AA64-02725F | CABINET-FRONT,BOT;42W5,HIPS,VO,G4309,SVM | 1    |        | S.N.A |
| 17 | AA64-02743A | BADGE-DECORATION;42W5,AL,NI,RS           | 1    |        |       |
| 18 | AA61-01128B | HOLDER-SIDE,A/V;43T7,ABS HB,G3676,SVM-11 | 1    |        | S.N.A |
| 19 | AA64-02780B | DOOR-AV;43T7,ABS HB,G3676,SVM-1132       | 1    |        |       |
| 20 | AA61-01132A | VELCRO-A;COMMANDO,BST1 1/4H              | 3    |        | S.N.A |
| 21 | AA61-01133A | VELCRO-B;COMMANDO,BST1 1/4H              | 3    |        | S.N.A |
| 22 | 6003-001019 | SCREW-TAPTITE;RH,+,B,M4,L12,ZPC(BLK),SWR | 4    | VC+CPC | S.N.A |
| 23 | AA64-02728A | CABINET-BACK, TOP;42W5,HIPS,HB,G4309     | 1    |        |       |
| 24 | 6003-001026 | SCREW-TAPTITE;RH,+,B,M4,L15,ZPC(BLK),SWR | 7    | CBT+CF |       |
| 25 | AA67-00204A | MIRROR-FRONT;42W5,FSM,870*633*446        | 1    |        |       |
| 26 | BP61-00008A | BRACKET-MIRROR,ASSY;42W5,SECC,T1.0,01123 | 2    |        | S.N.A |
| 27 | 6003-001026 | SCREW-TAPTITE;RH,+,B,M4,L15,ZPC(BLK),SWR | 4    | BM+CBT |       |
| 28 | AA64-02729B | CABINET-BACK,BOT;42W5,HIPS,VO,G4309      | 1    |        |       |
| 29 | 6005-001003 | SCREW-WOOD;HH,+,M4,L19,ZPC(BLK),SWRCH18A | 3    | HC+CW  |       |
| 30 | BP96-00038B | ASSY COVER P-TERMINAL,ANT;42W5,HIPS VO,B | 1    |        | S.N.A |
| 31 | 6003-001026 | SCREW-TAPTITE;RH,+,B,M4,L15,ZPC(BLK),SWR | 4    | TB+RJK |       |
| 32 | BP91-00252A | ASSY CHASSIS;HCM422WX/XAA,P55A           | 1    |        |       |
| 33 | AA60-00072B | SPACER-COVER,DUST;43,54,62J9,SPONGE 94HF | 1    |        | S.N.A |
| 34 | BP61-00025B | BRACKET-SCREEN,ASSY(R);42W5,SECC,T1.0,NE | 1    |        | S.N.A |
| 35 | BP61-00023B | BRACKET-SCREEN,ASSY(TOP);42W5,SECC,T1.0, | 1    |        | S.N.A |
| 36 | BP61-00026B | BRACKET-SCREEN,ASSY(L);42W5,SECC,T1.0,NE | 1    |        | S.N.A |
| 37 | BP61-00024B | BRACKET-SCREEN,ASSY(BOT);42W5,SECC,T1.0, | 1    |        | S.N.A |
| 38 | AA60-10011A | SCREW-TAPTITE;-SWRCH18A,M4,L12,HH,+,PC,  | 20   | BS+CF  | S.N.A |
| 39 | BP64-00029A | INLAY-SUPPORT;42W5,PS SHEET,T0.5,94V0    | 1    |        | S.N.A |
| 40 | 6005-001003 | SCREW-WOOD;HH,+,M4,L19,ZPC(BLK),SWRCH18A | 2    | IS+CW  |       |
| 41 | AA95-02002A | ASSY SUB-PCB,CG AMP;COMMANDO             | 1    |        |       |
| 42 | AA94-08270A | ASSY PCB MISC-DY JACK;COMMANDO           | 1    |        | S.N.A |
| 43 | AA26-00101A | TRANS FBT;FWZ50A001E/FFA97513B,12KV,5P,- | 1    |        |       |

## 7. Electrical Parts List

### 7-1 HCM4215WX/XAA

| Loc. No.            | Code No. | Description ; Specification                          | Remark | Loc. No. | Code No.    | Description ; Specification                           | Remark |
|---------------------|----------|--|--------|----------|-------------|---|--------|
| <b>ASSY CHASSIS</b> |          |  |        |          |             |   |        |
| 1                   | *        | BP91-00231A ASSY CHASSIS;HCM4215WX/MVT,P55A          | S.N.A  | ...      | GRW-SC      | BP39-00004C LEAD CONNECTOR ASSY;P55A/HCM4215W,UL3239  |        |
| ...                 |          |  |        | ...      | IC501       | AA96-50311L ASSY H/S;-AMP,AA62-30175D ,TDA6111Q,HE    | S.N.A  |
| ...                 |          |  |        | ...      | IC531       | AA96-50311L ASSY H/S;-AMP,AA62-30175D ,TDA6111Q,HE    | S.N.A  |
| ...                 |          |  |        | ...      | IC561       | AA96-50311L ASSY H/S;-AMP,AA62-30175D ,TDA6111Q,HE    | S.N.A  |
| ...                 |          |  |        | ...      | 1201-001131 | IC-VIDEO AMP;6111,SIP9P,-,SINGLE,-,PLAS               |        |
| ...                 | PM+HC    | 6003-001023 SCREW-TAPTITE;RW,H+,B,M3,L10,ZPC(YEL),SW | S.N.A  | ...      | 6003-000334 | SCREW-TAPTITE;RH,+2S,M3,L6,ZPC(YEL),SWR               | S.N.A  |
| ...                 | PP+HC    | 6003-001023 SCREW-TAPTITE;RW,H+,B,M3,L10,ZPC(YEL),SW | S.N.A  | ...      | AA62-30175D | HEAT-SINK,PS;-SECC,T1.0,-,33X15X30 FT-2               | S.N.A  |
| ...                 | SMW-GN   | AA39-20010D LEAD CONNECTOR-ASSY;,1P,YFH800-01,S,400, |        | ...      | Q371        | AA96-00244H ASSY H/S;SCREW,2SC4636(2),CRT,SLICON-OIL  | S.N.A  |
| ...                 |          | AA94-08575A ASSY PCB MISC-AV-FRONT;HCM4215W,P55A     | S.N.A  | ...      | 0205-000129 | GREASE-SILICON;SC102,JAPAN                            | S.N.A  |
| ...                 | CNW01A   | BP39-00016A LEAD CONNECTOR ASSY;P55A/HCM4215W,UL2547 |        | ...      | 0502-000442 | TR-POWER;2SC4636RB,NPN,2W,TO-220,ST,10-               |        |
| ...                 | CNW702   | AA39-00260A LEAD CONNECTOR ASSY;,UL1007#26,UL/CSA,3P |        | ...      | 6003-000335 | SCREW-TAPTITE;RH,+2S,M3,L8,ZPC(YEL),SWR               | S.N.A  |
| ...                 | CNY01A   | 3711-003601 CONNECTOR-HEADER;BOX,12P,1R,2.5mm,ANGLE  |        | ...      | AA62-00046A | HEAT SINK-PS;-T1.0,-,D1(DREAM) 60X25X                 | S.N.A  |
| ...                 | CNY702   | 3711-000447 CONNECTOR-HEADER;3WALL,3P,1R,2.5mm,ANGLE |        | ...      | RPW-SC      | BP39-00004B LEAD CONNECTOR ASSY;P55A/HCM4215W,UL3239  |        |
| ...                 | JK101    | 3722-000544 JACK-VHS;4P;11.5mm,AG,BLK,N              |        | ...      | SCW-GN      | AA39-00198D LEAD CONNECTOR ASSY;P55A/HCM4215W,UL1617  |        |
| ...                 | JK102    | 3722-001164 JACK-PIN;3P;3.4mm,SN,WH;YE,RE,#16-22     |        | ...      | SG301       | 4715-001050 SURGE ABSORBER;2.4kV,20%,1500A,-,DISC-RA  |        |
| ...                 | SW101    | 3404-000208 SWITCH-TACT;12V,50mA,120gf,6x6mm,SPST    |        | ...      | SG502       | AA27-00084A COIL;S-23,-,-,-,-,-,S-23,5000Mohm MIN,    |        |
| ...                 |          | BP96-00007F ASSY COVER P-SIDE;JACK;42W5,ABS HB G3676 |        | ...      | SG532       | AA27-00084A COIL;S-23,-,-,-,-,-,S-23,5000Mohm MIN,    |        |
| ...                 |          | AA61-01128F HOLDER-SIDE,A/V;42W5,ABS HB,G3676,DG703P | S.N.A  | ...      | SG562       | AA27-00084A COIL;S-23,-,-,-,-,-,S-23,5000Mohm MIN,    |        |
| ...                 |          | AA64-02086E INLAY-AV;W3,PS SHEET,TO.5,P55A           | S.N.A  | ...      | V501        | 3704-001019 SOCKET-CRT;10P;29.1PI,35.5PI,AU30U,-      |        |
| ...                 |          | AA64-02780F DOOR-AV;42W5,ABS HB,G3676,DG703P         |        | ...      | V531        | 3704-001019 SOCKET-CRT;10P;29.1PI,35.5PI,AU30U,-      |        |
| ...                 |          | 0202-000187 SOLDER-WIRE FLUX;-RS60S,D1.2.63Sn/37Pb   | S.N.A  | ...      | V561        | 3704-001019 SOCKET-CRT;10P;29.1PI,35.5PI,AU30U,-      |        |
| ...                 |          | AA97-07429A ASSY AUTO;0000                           | S.N.A  | ...      | VR501       | 2101-000321 VR-ROTARY;1Mohm,-,0.6W,SIDE               |        |
| ...                 | PCB      | AA41-00499B PCB-FRONT A/V;SVP-54T6SR,FR-1,1L,A,1.6T, | S.N.A  | ...      | VR531       | 2101-000321 VR-ROTARY;1Mohm,-,0.6W,SIDE               |        |
| ...                 | RK101    | 2001-000006 R-CARBON;2.4KOHM,5%,1/8W,AA,TP,1.8X3.2MM |        | ...      | VR561       | 2101-000321 VR-ROTARY;1Mohm,-,0.6W,SIDE               |        |
| ...                 |          | AA94-08576A ASSY PCB MISC-CONTROL;HCM4215W,P55A      |        | ...      | 3301-001201 | CORE-FERRITE;AE,21x11x32mm,1500,280G                  |        |
| ...                 | CNW01    | AA39-00223A LEAD CONNECTOR ASSY;,11P,67096-011,35155 |        | ...      | AA39-20010B | LEAD CONNECTOR-ASSY;,1P,YFH800-01,S,500,              |        |
| ...                 | CNW02    | AA39-00259A LEAD CONNECTOR ASSY;,UL1007#26,UL/CSA,3P |        | ...      | 0202-000187 | SOLDER-WIRE FLUX;-RS60S,D1.2.63Sn/37Pb                | S.N.A  |
| ...                 | CNY01    | 3711-003353 CONNECTOR-HEADER;BOX,11P,1R,2.5mm,ANGLE, |        | ...      | AA97-07608A | ASSY AUTO-CRT;HCM4215W                                | S.N.A  |
| ...                 | CNY02    | 3711-000447 CONNECTOR-HEADER;3WALL,3P,1R,2.5mm,ANGLE |        | ...      | C361        | 2306-000122 C-FILM,MPEF;100nF,5%,50V,TP,7.3x4.0x5.0mm |        |
| ...                 | LEDY01   | 0601-001381 LED;ROUND,RED;GRN,5.0MM,650/563NM        |        | ...      | C371        | 2401-000302 C-AL;100uF,20%,25V,GP,TP,6.3x11.5         |        |
| ...                 | RMY01    | AA32-00012A MODULE REMOCON;ORC-50HF2,38KHZ,940NM,MES |        | ...      | C372        | 2401-000480 C-AL;10uF,20%,50V,GP,TP,5x11.5            |        |
| ...                 | SWY01    | 3404-001006 SWITCH-TACT;12V,50mA,160gf,6x6mm,SPST    |        | ...      | C373        | 2401-000302 C-AL;100uF,20%,25V,GP,TP,6.3x11.5         |        |
| ...                 | SWY02    | 3404-001006 SWITCH-TACT;12V,50mA,160gf,6x6mm,SPST    |        | ...      | C374        | 2401-001621 C-AL;6.8uF,20%,450V,GP,TP,13x20.5         |        |
| ...                 | SWY03    | 3404-001006 SWITCH-TACT;12V,50mA,160gf,6x6mm,SPST    |        | ...      | C376        | 2201-000556 C-CERAMIC,DISC;0.47nF,10%,500V,Y5P,TP,5.  |        |
| ...                 | SWY04    | 3404-001006 SWITCH-TACT;12V,50mA,160gf,6x6mm,SPST    |        | ...      | C502        | 2401-000027 C-AL;4.7uF,20%,50V,GP,TP,5x11.5           |        |
| ...                 | SWY05    | 3404-001006 SWITCH-TACT;12V,50mA,160gf,6x6mm,SPST    |        | ...      | C503        | 2201-000119 C-CERAMIC,DISC;100nF,+80-20%,50V,Y5V,TP,  |        |
| ...                 | SWY06    | 3404-001006 SWITCH-TACT;12V,50mA,160gf,6x6mm,SPST    |        | ...      | C504        | 2401-001571 C-AL;47uF,+20%-0%,50V,GP,TP,8x11.5        |        |
| ...                 | SWY07    | 3404-001006 SWITCH-TACT;12V,50mA,160gf,6x6mm,SPST    |        | ...      | C505        | 2305-000149 C-FILM,MPEF;100nF,5%,100V,TP,12x12.5x6.5  |        |
| ...                 | SWY08    | 3404-001006 SWITCH-TACT;12V,50mA,160gf,6x6mm,SPST    |        | ...      | C506        | 2401-000430 C-AL;10uF,20%,250V,GP,TP,10x16mm,5m       |        |
| ...                 |          | 3301-001201 CORE-FERRITE;AE,21x11x32mm,1500,280G     |        | ...      | C507        | 2305-000154 C-FILM,MPEF;100nF,5%,400V,TP,21.5x6.5x11  |        |
| ...                 |          | 0202-000187 SOLDER-WIRE FLUX;-RS60S,D1.2.63Sn/37Pb   | S.N.A  | ...      | C510        | 2401-000430 C-AL;10uF,20%,250V,GP,TP,10x16mm,5m       |        |
| ...                 |          | AA97-07423A ASSY AUTO;0000                           | S.N.A  | ...      | C511        | 2201-000723 C-CERAMIC,DISC;4.7nF,20%,3KV,Y5U,TP,16x5  |        |
| ...                 | CY01     | 2401-002009 C-AL;100uF,20%,16V,GP,TP,6.3x7.5         |        | ...      | C512        | 2401-000133 C-AL;1000uF,20%,16V,GP,TP,10x20.5         |        |
| ...                 | DZY02    | 0403-000510 DIODE-ZENER;MTZJ6.2B,6.2V,5.96-6.27V,500 |        | ...      | C513        | 2201-000983 C-CERAMIC,DISC;1nF,10%,2kV,Y5P,TP,9x5.7   |        |
| ...                 | DZY03    | 0403-000510 DIODE-ZENER;MTZJ6.2B,6.2V,5.96-6.27V,500 |        | ...      | C514        | 2201-000599 C-CERAMIC,DISC;0.56nF,10%,500V,Y5P,TP,5.  |        |
| ...                 | PCB      | BP41-00001C PCB-CONTROL;SVP-42W5HD,FR-1,1L,C,1.6T,33 | S.N.A  | ...      | C532        | 2401-000027 C-AL;4.7uF,20%,50V,GP,TP,5x11.5           |        |
| ...                 | QY01     | 0504-000123 TR-DIGITAL;KSR1010,NPN,300mW,10K,TO-92,T |        | ...      | C533        | 2201-000119 C-CERAMIC,DISC;100nF,+80-20%,50V,Y5V,TP,  |        |
| ...                 | RY02     | 2001-000832 R-CARBON;5100HM,5%,1/8W,AA,TP,1.8X3.2MM  |        | ...      | C534        | 2401-001571 C-AL;47uF,+20%-0%,50V,GP,TP,8x11.5        |        |
| ...                 | RY03     | 2001-000832 R-CARBON;5100HM,5%,1/8W,AA,TP,1.8X3.2MM  |        | ...      | C535        | 2305-000149 C-FILM,MPEF;100nF,5%,100V,TP,12x12.5x6.5  |        |
| ...                 | RY04     | 2001-000429 R-CARBON;1KOHM,5%,1/8W,AA,TP,1.8X3.2MM   |        | ...      | C536        | 2401-000430 C-AL;10uF,20%,250V,GP,TP,10x16mm,5m       |        |
| ...                 | RY05     | 2001-000832 R-CARBON;5100HM,5%,1/8W,AA,TP,1.8X3.2MM  |        | ...      | C537        | 2305-000154 C-FILM,MPEF;100nF,5%,400V,TP,21.5x6.5x11  |        |
| ...                 | RY06     | 2001-000924 R-CARBON;6800HM,5%,1/8W,AA,TP,1.8X3.2MM  |        | ...      | C540        | 2401-000430 C-AL;10uF,20%,250V,GP,TP,10x16mm,5m       |        |
| ...                 | RY07     | 2001-000020 R-CARBON(S);220HM,5%,1/2W,AA,TP,2.4X6.4M |        | ...      | C541        | 2201-000723 C-CERAMIC,DISC;4.7nF,20%,3KV,Y5U,TP,16x5  |        |
| ...                 | RY08     | 2001-001108 R-CARBON(S);22KOHM,5%,1/2W,AA,TP,2.4X6.4 |        | ...      | C543        | 2201-000983 C-CERAMIC,DISC;1nF,10%,2kV,Y5P,TP,9x5.7   |        |
| ...                 | RY09     | 2001-000109 R-CARBON(S);4700HM,5%,1/2W,AA,TP,2.4X6.4 |        | ...      | C544        | 2201-000599 C-CERAMIC,DISC;0.56nF,10%,500V,Y5P,TP,5.  |        |
| ...                 |          | AA94-08582A ASSY PCB MISC-CRT-COMMANDO,C2            |        | ...      | C562        | 2401-000027 C-AL;4.7uF,20%,50V,GP,TP,5x11.5           |        |
| ...                 | CN501    | 3711-002648 CONNECTOR-HEADER;BOX,9P,1R,2.5mm,STRAIGH |        | ...      | C563        | 2201-000119 C-CERAMIC,DISC;100nF,+80-20%,50V,Y5V,TP,  |        |
| ...                 | CN502    | 3711-003052 CONNECTOR-HEADER;BOX,10P,1R,2.5MM,STRAIG |        | ...      | C564        | 2401-001571 C-AL;47uF,+20%-0%,50V,GP,TP,8x11.5        |        |
| ...                 | CN502B   | 3711-003052 CONNECTOR-HEADER;BOX,10P,1R,2.5MM,STRAIG |        | ...      | C565        | 2305-000149 C-FILM,MPEF;100nF,5%,100V,TP,12x12.5x6.5  |        |
| ...                 | CN503    | 3711-003973 CONNECTOR-HEADER;BOX,11P,1R,2.5mm,STRAIG |        | ...      | C566        | 2401-000430 C-AL;10uF,20%,250V,GP,TP,10x16mm,5m       |        |
| ...                 | CN503R   | 3711-003973 CONNECTOR-HEADER;BOX,11P,1R,2.5mm,STRAIG |        | ...      | C567        | 2305-000154 C-FILM,MPEF;100nF,5%,400V,TP,21.5x6.5x11  |        |
| ...                 | CN504    | 3711-002645 CONNECTOR-HEADER;BOX,6P,1R,2.5mm,STRAIGH |        | ...      | C570        | 2401-000430 C-AL;10uF,20%,250V,GP,TP,10x16mm,5m       |        |
| ...                 | CNW401   | AA39-20027B LEAD CONNECTOR-ASSY;,6P,67096-006,S,400, |        | ...      | C571        | 2201-000723 C-CERAMIC,DISC;4.7nF,20%,3KV,Y5U,TP,16x5  |        |
| ...                 | CNW501   | AA39-20031D LEAD CONNECTOR-ASSY;,9P,67096-009,S,500, |        | ...      | C573        | 2201-000983 C-CERAMIC,DISC;1nF,10%,2kV,Y5P,TP,9x5.7   |        |
| ...                 | CNW502   | AA39-00112A LEAD CONNECTOR-ASSY;,10P,35155-1000,S,30 |        | ...      | C574        | 2201-000599 C-CERAMIC,DISC;0.56nF,10%,500V,Y5P,TP,5.  |        |
| ...                 | CNW503   | AA39-00120F LEAD CONNECTOR ASSY;SIR-T165,UL1007#26,U |        | ...      | D361        | 0401-000005 DIODE-SWITCHING;1N4148,100V,200mA,DO-35,  |        |
| ...                 | GBW-GN   | AA39-20010D LEAD CONNECTOR-ASSY;,1P,YFH800-01,S,400, |        | ...      | D362        | 0401-000005 DIODE-SWITCHING;1N4148,100V,200mA,DO-35,  |        |
| ...                 | GBW-SC   | BP39-00004C LEAD CONNECTOR ASSY;P55A/HCM4215W,UL3239 |        | ...      | D371        | 0401-000005 DIODE-SWITCHING;1N4148,100V,200mA,DO-35,  |        |
| ...                 | GRW-GN   | AA39-20010D LEAD CONNECTOR-ASSY;,1P,YFH800-01,S,400, |        | ...      | D372        | 0401-000005 DIODE-SWITCHING;1N4148,100V,200mA,DO-35,  |        |

Electrical Parts List

| Loc. No. | Code No. | Description ; Specification                          | Remark | Loc. No. | Code No. | Description ; Specification                          | Remark |
|----------|----------|--|--------|----------|----------|--|--------|
| ....     | D373     | 0402-000243 DIODE-RECTIFIER;RC2-V1,2000V,0.2A,DO-201 |        | ....     | R361     | 2001-001097 R-CARBON(S);2.4KOHM,5%,1/2W,AA,TP,2.4X6. |        |
| ....     | D501     | 0402-000546 DIODE-RECTIFIER;TVR10G,400V,1.0A,DO-41,T |        | ....     | R362     | 2001-000660 R-CARBON;33KOHM,5%,1/8W,AA,TP,1.8X3.2MM  |        |
| ....     | D502     | 0402-000546 DIODE-RECTIFIER;TVR10G,400V,1.0A,DO-41,T |        | ....     | R363     | 2001-000723 R-CARBON;4.3KOHM,5%,1/8W,AA,TP,1.8X3.2MM |        |
| ....     | D503     | 0402-000493 DIODE-RECTIFIER;1R5GU41,400V,1.5A,DO-15L |        | ....     | R364     | 2001-000938 R-CARBON;680HM,5%,1/8W,AA,TP,1.8X3.2MM   |        |
| ....     | D504     | 0401-000005 DIODE-SWITCHING;1N4148,100V,200mA,DO-35, |        | ....     | R365     | 2001-001120 R-CARBON(S);3.30HM,5%,1/2W,AA,TP,2.4X6.4 |        |
| ....     | D509     | 0401-000005 DIODE-SWITCHING;1N4148,100V,200mA,DO-35, |        | ....     | R366     | 2001-000109 R-CARBON(S);4700HM,5%,1/2W,AA,TP,2.4X6.4 |        |
| ....     | D510     | 0401-000005 DIODE-SWITCHING;1N4148,100V,200mA,DO-35, |        | ....     | R367     | 2001-001065 R-CARBON(S);110KOHM,5%,1/2W,AA,TP,2.4X6. |        |
| ....     | D531     | 0402-000546 DIODE-RECTIFIER;TVR10G,400V,1.0A,DO-41,T |        | ....     | R368     | 2001-001065 R-CARBON(S);110KOHM,5%,1/2W,AA,TP,2.4X6. |        |
| ....     | D532     | 0402-000546 DIODE-RECTIFIER;TVR10G,400V,1.0A,DO-41,T |        | ....     | R369     | 2001-001065 R-CARBON(S);110KOHM,5%,1/2W,AA,TP,2.4X6. |        |
| ....     | D533     | 0402-000493 DIODE-RECTIFIER;1R5GU41,400V,1.5A,DO-15L |        | ....     | R369A    | 2001-001065 R-CARBON(S);110KOHM,5%,1/2W,AA,TP,2.4X6. |        |
| ....     | D561     | 0402-000546 DIODE-RECTIFIER;TVR10G,400V,1.0A,DO-41,T |        | ....     | R370     | 2001-001065 R-CARBON(S);110KOHM,5%,1/2W,AA,TP,2.4X6. |        |
| ....     | D562     | 0402-000546 DIODE-RECTIFIER;TVR10G,400V,1.0A,DO-41,T |        | ....     | R371     | 2001-001065 R-CARBON(S);110KOHM,5%,1/2W,AA,TP,2.4X6. |        |
| ....     | D563     | 0402-000493 DIODE-RECTIFIER;1R5GU41,400V,1.5A,DO-15L |        | ....     | R372     | 2001-001110 R-CARBON(S);240KOHM,5%,1/2W,AA,TP,2.4X6. |        |
| ....     | DZ501    | 0403-000334 DIODE-ZENER;UZ2.7BSA,2.7V,2.54-2.75V,500 |        | ....     | R373     | 2001-001110 R-CARBON(S);240KOHM,5%,1/2W,AA,TP,2.4X6. |        |
| ....     | DZ502    | 0403-000508 DIODE-ZENER;MTZJ5.6B,5.6V,5.45-5.73V,500 |        | ....     | R374     | 2001-001110 R-CARBON(S);240KOHM,5%,1/2W,AA,TP,2.4X6. |        |
| ....     | DZ503    | 0403-000708 DIODE-ZENER;MTZJ13B,13V,12.55-13.21V,500 |        | ....     | R375     | 2001-001113 R-CARBON(S);270KOHM,5%,1/2W,AA,TP,2.4X6. |        |
| ....     | DZ531    | 0403-000334 DIODE-ZENER;UZ2.7BSA,2.7V,2.54-2.75V,500 |        | ....     | R376     | 2001-000613 R-CARBON;3.9KOHM,5%,1/8W,AA,TP,1.8X3.2MM |        |
| ....     | DZ532    | 0403-000508 DIODE-ZENER;MTZJ5.6B,5.6V,5.45-5.73V,500 |        | ....     | R377     | 2004-001892 R-METAL(S);162Kohm,1%,1/2W,AA,TP,2.5x6.5 |        |
| ....     | DZ533    | 0403-000708 DIODE-ZENER;MTZJ13B,13V,12.55-13.21V,500 |        | ....     | R378     | 2004-001892 R-METAL(S);162Kohm,1%,1/2W,AA,TP,2.5x6.5 |        |
| ....     | DZ561    | 0403-000334 DIODE-ZENER;UZ2.7BSA,2.7V,2.54-2.75V,500 |        | ....     | R379     | 2004-001892 R-METAL(S);162Kohm,1%,1/2W,AA,TP,2.5x6.5 |        |
| ....     | DZ562    | 0403-000508 DIODE-ZENER;MTZJ5.6B,5.6V,5.45-5.73V,500 |        | ....     | R380     | 2004-001892 R-METAL(S);162Kohm,1%,1/2W,AA,TP,2.5x6.5 |        |
| ....     | DZ563    | 0403-000708 DIODE-ZENER;MTZJ13B,13V,12.55-13.21V,500 |        | ....     | R381     | 2001-001088 R-CARBON(S);1KOHM,5%,1/2W,AA,TP,2.4X6.4M |        |
| ....     | EL01     | AA60-40011B EYELET;ID2.2,OD3.2,-,BSP-                | S.N.A  | ....     | R382     | 2002-001006 R-COMPOSITION;4.7KOHM,15%,1/2W,AA,TP,3.7 |        |
| ....     | EL02     | AA60-40011B EYELET;ID2.2,OD3.2,-,BSP-                | S.N.A  | ....     | R500     | 2001-000613 R-CARBON;3.9KOHM,5%,1/8W,AA,TP,1.8X3.2MM |        |
| ....     | EL03     | AA60-40011A EYELET;ID2.0,OD2.8,-,BST-                | S.N.A  | ....     | R502     | 2001-000995 R-CARBON;820OHM,5%,1/8W,AA,TP,1.8X3.2MM  |        |
| ....     | EL04     | AA60-40011B EYELET;ID2.2,OD3.2,-,BSP-                | S.N.A  | ....     | R503     | 2001-000429 R-CARBON;1KOHM,5%,1/8W,AA,TP,1.8X3.2MM   |        |
| ....     | EL05     | AA60-40011B EYELET;ID2.2,OD3.2,-,BSP-                | S.N.A  | ....     | R504     | 2001-000006 R-CARBON;2.4KOHM,5%,1/8W,AA,TP,1.8X3.2MM |        |
| ....     | EL06     | AA60-40011A EYELET;ID2.0,OD2.8,-,BST-                | S.N.A  | ....     | R505     | 2001-000362 R-CARBON;1500HM,5%,1/8W,AA,TP,1.8X3.2MM  |        |
| ....     | EL503    | AA60-40011B EYELET;ID2.2,OD3.2,-,BSP-                | S.N.A  | ....     | R506     | 2001-001049 R-CARBON(S);1.3KOHM,5%,1/2W,AA,TP,2.4X6. |        |
| ....     | EL504    | AA60-40011B EYELET;ID2.2,OD3.2,-,BSP-                | S.N.A  | ....     | R507     | 2001-001088 R-CARBON(S);1KOHM,5%,1/2W,AA,TP,2.4X6.4M |        |
| ....     | EL505    | AA60-40011B EYELET;ID2.2,OD3.2,-,BSP-                | S.N.A  | ....     | R508     | 2003-000738 R-METAL OXIDE(S);56Kohm,5%,2W,AA,TP,4x12 |        |
| ....     | EL533    | AA60-40011B EYELET;ID2.2,OD3.2,-,BSP-                | S.N.A  | ....     | R509     | 2001-000734 R-CARBON;4.7KOHM,5%,1/8W,AA,TP,1.8X3.2MM |        |
| ....     | EL534    | AA60-40011B EYELET;ID2.2,OD3.2,-,BSP-                | S.N.A  | ....     | R510     | 2001-000908 R-CARBON;62KOHM,5%,1/8W,AA,TP,1.8X3.2MM  |        |
| ....     | EL535    | AA60-40011B EYELET;ID2.2,OD3.2,-,BSP-                | S.N.A  | ....     | R511     | 2001-000281 R-CARBON;1000HM,5%,1/8W,AA,TP,1.8X3.2MM  |        |
| ....     | EL536    | AA60-40011B EYELET;ID2.2,OD3.2,-,BSP-                | S.N.A  | ....     | R513     | 2008-001129 R-FUSIBLE(S);1.5ohm,5%,1/2W,AF,TP,2.5x6. |        |
| ....     | EL537    | AA60-40011B EYELET;ID2.2,OD3.2,-,BSP-                | S.N.A  | ....     | R514     | 2001-001122 R-CARBON(S);3.9KOHM,5%,1/2W,AA,TP,2.4X6. |        |
| ....     | EL563    | AA60-40011B EYELET;ID2.2,OD3.2,-,BSP-                | S.N.A  | ....     | R515     | 2002-001017 R-COMPOSITION;1Kohm,10%,1/2W,AA,TP,3.7x9 |        |
| ....     | EL564    | AA60-40011B EYELET;ID2.2,OD3.2,-,BSP-                | S.N.A  | ....     | R516     | 2001-000009 R-CARBON;20KOHM,5%,1/8W,AA,TP,1.8X3.2MM  |        |
| ....     | EL565    | AA60-40011B EYELET;ID2.2,OD3.2,-,BSP-                | S.N.A  | ....     | R517     | 2001-000085 R-CARBON(S);100KOHM,5%,1/2W,AA,TP,2.4X6. |        |
| ....     | EL566    | AA60-40011A EYELET;ID2.2,OD3.2,-,BSP-                | S.N.A  | ....     | R518     | 2002-001021 R-COMPOSITION;560KOHM,10%,1/2W,AA,TP,3.7 |        |
| ....     | EL567    | AA60-40011B EYELET;ID2.2,OD3.2,-,BSP-                | S.N.A  | ....     | R519     | 2002-001021 R-COMPOSITION;560KOHM,10%,1/2W,AA,TP,3.7 |        |
| ....     | GT371    | AA60-40014A PIN-GT,ASSY;1P,-,AUTO                    | S.N.A  | ....     | R520     | 2001-000066 R-CARBON(S);10KOHM,5%,1/2W,AA,TP,2.4X6.4 |        |
| ....     | GT372    | AA60-40014A PIN-GT,ASSY;1P,-,AUTO                    | S.N.A  | ....     | R521     | 2001-001052 R-CARBON(S);1.5MOHM,5%,1/2W,AA,TP,2.4X6. |        |
| ....     | GT373    | AA60-40014A PIN-GT,ASSY;1P,-,AUTO                    | S.N.A  | ....     | R522     | 2002-001006 R-COMPOSITION;4.7KOHM,15%,1/2W,AA,TP,3.7 |        |
| ....     | GT374    | AA60-40014A PIN-GT,ASSY;1P,-,AUTO                    | S.N.A  | ....     | R523     | 2002-001006 R-COMPOSITION;4.7KOHM,15%,1/2W,AA,TP,3.7 |        |
| ....     | GT501    | AA60-40014A PIN-GT,ASSY;1P,-,AUTO                    | S.N.A  | ....     | R524     | 2001-000028 R-CARBON(S);1000HM,5%,1/2W,AA,TP,2.4X6.4 |        |
| ....     | GT502    | AA60-40014A PIN-GT,ASSY;1P,-,AUTO                    | S.N.A  | ....     | R526     | 2001-000539 R-CARBON;24KOHM,5%,1/8W,AA,TP,1.8X3.2MM  |        |
| ....     | GT503    | AA60-40014A PIN-GT,ASSY;1P,-,AUTO                    | S.N.A  | ....     | R527     | 2001-000577 R-CARBON;2KOHM,5%,1/8W,AA,TP,1.8X3.2MM   |        |
| ....     | GT504    | AA60-40014A PIN-GT,ASSY;1P,-,AUTO                    | S.N.A  | ....     | R528     | 2001-001015 R-CARBON;9.1KOHM,5%,1/8W,AA,TP,1.8X3.2MM |        |
| ....     | GT506    | AA60-40014A PIN-GT,ASSY;1P,-,AUTO                    | S.N.A  | ....     | R529     | 2002-001021 R-COMPOSITION;560KOHM,10%,1/2W,AA,TP,3.7 |        |
| ....     | GT531    | AA60-40014A PIN-GT,ASSY;1P,-,AUTO                    | S.N.A  | ....     | R530     | 2001-000429 R-CARBON;1KOHM,5%,1/8W,AA,TP,1.8X3.2MM   |        |
| ....     | GT532    | AA60-40014A PIN-GT,ASSY;1P,-,AUTO                    | S.N.A  | ....     | R531     | 2001-000290 R-CARBON;10KOHM,5%,1/8W,AA,TP,1.8X3.2MM  |        |
| ....     | GT533    | AA60-40014A PIN-GT,ASSY;1P,-,AUTO                    | S.N.A  | ....     | R532     | 2001-000995 R-CARBON;820OHM,5%,1/8W,AA,TP,1.8X3.2MM  |        |
| ....     | GT534    | AA60-40014A PIN-GT,ASSY;1P,-,AUTO                    | S.N.A  | ....     | R533     | 2001-000429 R-CARBON;1KOHM,5%,1/8W,AA,TP,1.8X3.2MM   |        |
| ....     | GT535    | AA60-40014A PIN-GT,ASSY;1P,-,AUTO                    | S.N.A  | ....     | R534     | 2001-000563 R-CARBON;27KOHM,5%,1/8W,AA,TP,1.8X3.2MM  |        |
| ....     | GT536    | AA60-40014A PIN-GT,ASSY;1P,-,AUTO                    | S.N.A  | ....     | R536     | 2001-001049 R-CARBON(S);1.3KOHM,5%,1/2W,AA,TP,2.4X6. |        |
| ....     | GT537    | AA60-40014A PIN-GT,ASSY;1P,-,AUTO                    | S.N.A  | ....     | R537     | 2001-001088 R-CARBON(S);1KOHM,5%,1/2W,AA,TP,2.4X6.4M |        |
| ....     | GT561    | AA60-40014A PIN-GT,ASSY;1P,-,AUTO                    | S.N.A  | ....     | R538     | 2003-000738 R-METAL OXIDE(S);56Kohm,5%,2W,AA,TP,4x12 |        |
| ....     | GT562    | AA60-40014A PIN-GT,ASSY;1P,-,AUTO                    | S.N.A  | ....     | R540     | 2001-000908 R-CARBON;62KOHM,5%,1/8W,AA,TP,1.8X3.2MM  |        |
| ....     | GT563    | AA60-40014A PIN-GT,ASSY;1P,-,AUTO                    | S.N.A  | ....     | R541     | 2001-000009 R-CARBON;20KOHM,5%,1/8W,AA,TP,1.8X3.2MM  |        |
| ....     | GT564    | AA60-40014A PIN-GT,ASSY;1P,-,AUTO                    | S.N.A  | ....     | R542     | 2001-000890 R-CARBON;6.8KOHM,5%,1/8W,AA,TP,1.8X3.2MM |        |
| ....     | GT567    | AA60-40014A PIN-GT,ASSY;1P,-,AUTO                    | S.N.A  | ....     | R543     | 2008-001129 R-FUSIBLE(S);1.5ohm,5%,1/2W,AF,TP,2.5x6. |        |
| ....     | GT568    | AA60-40014A PIN-GT,ASSY;1P,-,AUTO                    | S.N.A  | ....     | R544     | 2001-001122 R-CARBON(S);3.9KOHM,5%,1/2W,AA,TP,2.4X6. |        |
| ....     | L501     | 2701-000114 INDUCTOR-AXIAL;10uH,10%,2.5x3.4mm        |        | ....     | R545     | 2002-001017 R-COMPOSITION;1Kohm,10%,1/2W,AA,TP,3.7x9 |        |
| ....     | L531     | 2701-000114 INDUCTOR-AXIAL;10uH,10%,2.5x3.4mm        |        | ....     | R546     | 2001-000009 R-CARBON;20KOHM,5%,1/8W,AA,TP,1.8X3.2MM  |        |
| ....     | L561     | 2701-000168 INDUCTOR-AXIAL;3.3uH,5%,2.5x3.4mm        |        | ....     | R547     | 2001-000085 R-CARBON(S);100KOHM,5%,1/2W,AA,TP,2.4X6. |        |
| ....     | PCB      | AA41-00600A PCB-CRT,FR-1,1L,A,1.6T,245X245,COMMANDO  | S.N.A  | ....     | R548     | 2002-001021 R-COMPOSITION;560KOHM,10%,1/2W,AA,TP,3.7 |        |
| ....     | Q361     | 0501-000283 TR-SMALL SIGNAL;KSA539,PNP,400mW,TO-92,T |        | ....     | R549     | 2002-001021 R-COMPOSITION;560KOHM,10%,1/2W,AA,TP,3.7 |        |
| ....     | Q362     | 0501-000366 TR-SMALL SIGNAL;KSC2330-Y,NPN,1W,TO-92L, |        | ....     | R550     | 2001-000066 R-CARBON(S);10KOHM,5%,1/2W,AA,TP,2.4X6.4 |        |
| ....     | Q501     | 0502-000006 TR-POWER;KSC1507,NPN,15W,TO-220,TP,120-  |        | ....     | R551     | 2001-001052 R-CARBON(S);1.5MOHM,5%,1/2W,AA,TP,2.4X6. |        |
| ....     | Q502     | 0501-000389 TR-SMALL SIGNAL;KSC815,NPN,400mW,TO-92,T |        | ....     | R552     | 2002-001006 R-COMPOSITION;4.7KOHM,15%,1/2W,AA,TP,3.7 |        |
| ....     | Q504     | 0501-000283 TR-SMALL SIGNAL;KSA539,PNP,400mW,TO-92,T |        | ....     | R553     | 2002-001006 R-COMPOSITION;4.7KOHM,15%,1/2W,AA,TP,3.7 |        |
| ....     | Q531     | 0502-000006 TR-POWER;KSC1507,NPN,15W,TO-220,TP,120-  |        | ....     | R554     | 2001-000028 R-CARBON(S);1000HM,5%,1/2W,AA,TP,2.4X6.4 |        |
| ....     | Q533     | 0501-000283 TR-SMALL SIGNAL;KSA539,PNP,400mW,TO-92,T |        | ....     | R555     | 2001-000734 R-CARBON;4.7KOHM,5%,1/8W,AA,TP,1.8X3.2MM |        |
| ....     | Q534     | 0501-000283 TR-SMALL SIGNAL;KSA539,PNP,400mW,TO-92,T |        | ....     | R556     | 2001-000007 R-CARBON;3KOHM,5%,1/8W,AA,TP,1.8X3.2MM   |        |
| ....     | Q561     | 0502-000006 TR-POWER;KSC1507,NPN,15W,TO-220,TP,120-  |        | ....     | R557     | 2001-000362 R-CARBON;1500HM,5%,1/8W,AA,TP,1.8X3.2MM  |        |
| ....     | Q563     | 0501-000283 TR-SMALL SIGNAL;KSA539,PNP,400mW,TO-92,T |        | ....     | R558     | 2001-000319 R-CARBON;120KOHM,5%,1/8W,AA,TP,1.8X3.2MM |        |



| Loc. No. | Code No.    | Description ; Specification              | Remark                                    | Loc. No. | Code No.    | Description ; Specification             | Remark                                   |  |
|----------|-------------|--|---|----------|-------------|---|--|--|
| ...4     | R559        | 2002-001015                              | R-COMPOSITION;47Kohm,5%,1/2W,AA,TP,3.7x9  | ...4     | CZ152       | 2202-000121                             | C-CERAMIC,MLC-AXIAL;100pF,10%,50V,Y5P,TP |  |
| ...4     | R562        | 2001-000232                              | R-CARBON;1.3KOHM,5%,1/8W,AA,TP,1.8X3.2MM  | ...4     | CZ153       | 2202-000121                             | C-CERAMIC,MLC-AXIAL;100pF,10%,50V,Y5P,TP |  |
| ...4     | R563        | 2001-000429                              | R-CARBON;1KOHM,5%,1/8W,AA,TP,1.8X3.2MM    | ...4     | CZ154       | 2202-000121                             | C-CERAMIC,MLC-AXIAL;100pF,10%,50V,Y5P,TP |  |
| ...4     | R564        | 2001-000908                              | R-CARBON;62KOHM,5%,1/8W,AA,TP,1.8X3.2MM   | ...4     | CZ155       | 2202-000121                             | C-CERAMIC,MLC-AXIAL;100pF,10%,50V,Y5P,TP |  |
| ...4     | R566        | 2001-001049                              | R-CARBON(S);1.3KOHM,5%,1/2W,AA,TP,2.4X6   | ...4     | CZ156       | 2202-000121                             | C-CERAMIC,MLC-AXIAL;100pF,10%,50V,Y5P,TP |  |
| ...4     | R567        | 2001-001088                              | R-CARBON(S);1KOHM,5%,1/2W,AA,TP,2.4X6.4M  | ...4     | ELZ01       | AA60-40011A                             | EYELET;ID2.0,OD2.8,-,BST,-               |  |
| ...4     | R568        | 2001-000734                              | R-CARBON;4.7KOHM,5%,1/8W,AA,TP,1.8X3.2MM  | ...4     | ELZ02       | AA60-40011A                             | EYELET;ID2.0,OD2.8,-,BST,-               |  |
| ...4     | R569        | 2001-000472                              | R-CARBON;2.7KOHM,5%,1/8W,AA,TP,1.8X3.2MM  | ...4     | ELZ03       | AA60-40011A                             | EYELET;ID2.0,OD2.8,-,BST,-               |  |
| ...4     | R570        | 2001-000362                              | R-CARBON;150OHM,5%,1/8W,AA,TP,1.8X3.2MM   | △ ...4   | FD101S      | 3601-001065                             | FUSE-AXIAL LEAD;125V,3.5A,FAST-ACTING,CE |  |
| ...4     | R571        | 2001-000281                              | R-CARBON;100OHM,5%,1/8W,AA,TP,1.8X3.2MM   | △ ...4   | FD102S      | 3601-001065                             | FUSE-AXIAL LEAD;125V,3.5A,FAST-ACTING,CE |  |
| ...4     | R573        | 2008-001129                              | R-FUSIBLE(S);1.5ohm,5%,1/2W,AF,TP,2.5x6   | ...4     | LZ107       | 2701-000142                             | INDUCTOR-AXIAL;1uH,10%,2.5x3.4mm         |  |
| ...4     | R574        | 2001-001122                              | R-CARBON(S);3.9KOHM,5%,1/2W,AA,TP,2.4X6   | ...4     | LZ108       | 2701-000142                             | INDUCTOR-AXIAL;1uH,10%,2.5x3.4mm         |  |
| ...4     | R575        | 2002-001017                              | R-COMPOSITION;1Kohm,10%,1/2W,AA,TP,3.7x9  | ...4     | LZ109       | 2701-000142                             | INDUCTOR-AXIAL;1uH,10%,2.5x3.4mm         |  |
| ...4     | R576        | 2001-000009                              | R-CARBON;20KOHM,5%,1/8W,AA,TP,1.8X3.2MM   | ...4     | LZ110       | 2701-000142                             | INDUCTOR-AXIAL;1uH,10%,2.5x3.4mm         |  |
| ...4     | R577        | 2001-000085                              | R-CARBON(S);100KOHM,5%,1/2W,AA,TP,2.4X6   | ...4     | LZ111       | 2701-000142                             | INDUCTOR-AXIAL;1uH,10%,2.5x3.4mm         |  |
| ...4     | R578        | 2002-001021                              | R-COMPOSITION;560KOHM,10%,1/2W,AA,TP,3.7  | ...4     | LZ112       | 2701-000142                             | INDUCTOR-AXIAL;1uH,10%,2.5x3.4mm         |  |
| ...4     | R579        | 2002-001021                              | R-COMPOSITION;560KOHM,10%,1/2W,AA,TP,3.7  | ...4     | PCB         | AA41-00601A                             | PCB-CG AMP,-CEM-1,1L,A,1.6T,245X245,COMM |  |
| ...4     | R580        | 2001-000066                              | R-CARBON(S);1KOHM,5%,1/2W,AA,TP,2.4X6.4   | ...4     | R856        | 2001-001155                             | R-CARBON(S);5.6KOHM,5%,1/2W,AA,TP,2.4X6  |  |
| ...4     | R581        | 2001-001052                              | R-CARBON(S);1.5MOHM,5%,1/2W,AA,TP,2.4X6   | ...4     | R857        | 2001-001155                             | R-CARBON(S);5.6KOHM,5%,1/2W,AA,TP,2.4X6  |  |
| ...4     | R582        | 2002-001006                              | R-COMPOSITION;4.7KOHM,15%,1/2W,AA,TP,3.7  | ...4     | RFZ19       | 2008-000261                             | R-FUSIBLE(S);150ohm,5%,1W,AF,TP,3.9x10mm |  |
| ...4     | R583        | 2002-001006                              | R-COMPOSITION;4.7KOHM,15%,1/2W,AA,TP,3.7  | ...4     | RFZ20       | 2008-000261                             | R-FUSIBLE(S);150ohm,5%,1W,AF,TP,3.9x10mm |  |
| ...4     | R584        | 2001-000028                              | R-CARBON(S);100OHM,5%,1/2W,AA,TP,2.4X6.4  | ...4     | RFZ21       | 2008-000261                             | R-FUSIBLE(S);150ohm,5%,1W,AF,TP,3.9x10mm |  |
| ...4     | R588        | 2003-000738                              | R-METAL OXIDE(S);56Kohm,5%,2W,AA,TP,4x12  | ...4     | RFZ22       | 2008-000261                             | R-FUSIBLE(S);150ohm,5%,1W,AF,TP,3.9x10mm |  |
| ...4     | R589        | 2002-001015                              | R-COMPOSITION;47Kohm,5%,1/2W,AA,TP,3.7x9  | ...4     | RFZ50       | 2008-000261                             | R-FUSIBLE(S);150ohm,5%,1W,AF,TP,3.9x10mm |  |
| ...4     | SG501       | 4715-001036                              | SURGE ABSORBER;500V,20%,-,TP              | ...4     | RFZ51       | 2008-000261                             | R-FUSIBLE(S);150ohm,5%,1W,AF,TP,3.9x10mm |  |
| ...4     | SG503       | 4715-001036                              | SURGE ABSORBER;500V,20%,-,TP              | ...4     | RFZ52       | 2008-000261                             | R-FUSIBLE(S);150ohm,5%,1W,AF,TP,3.9x10mm |  |
| ...4     | SG531       | 4715-001036                              | SURGE ABSORBER;500V,20%,-,TP              | ...4     | RFZ53       | 2008-000261                             | R-FUSIBLE(S);150ohm,5%,1W,AF,TP,3.9x10mm |  |
| ...4     | SG533       | 4715-001036                              | SURGE ABSORBER;500V,20%,-,TP              | ...4     | RZ104       | 2001-001114                             | R-CARBON(S);2700HM,5%,1/2W,AA,TP,2.4X6.4 |  |
| ...4     | SG561       | 4715-001036                              | SURGE ABSORBER;500V,20%,-,TP              | ...4     | RZ105       | 2001-001114                             | R-CARBON(S);2700HM,5%,1/2W,AA,TP,2.4X6.4 |  |
| ...4     | SG563       | 4715-001036                              | SURGE ABSORBER;500V,20%,-,TP              | ...4     | RZ106       | 2001-001114                             | R-CARBON(S);2700HM,5%,1/2W,AA,TP,2.4X6.4 |  |
| ...3     | BP59-00005A | MODULE-FOCUS PACK ASSY;RJT TV,F301-P03A  |   | ...4     | RZ107       | 2001-001114                             | R-CARBON(S);2700HM,5%,1/2W,AA,TP,2.4X6.4 |  |
| ...2     | AA95-02002A | ASSY SUB-PCB,CG AMP,COMMANDO             |   | ...4     | RZ108       | 2001-001114                             | R-CARBON(S);2700HM,5%,1/2W,AA,TP,2.4X6.4 |  |
| ...3     | CNW01       | BP39-00005A                              | LEAD CONNECTOR ASSY;P55A/HCM4215W,UL2547  | ...4     | RZ109       | 2001-001114                             | R-CARBON(S);2700HM,5%,1/2W,AA,TP,2.4X6.4 |  |
| ...3     | CNW03       | BP39-00015A                              | LEAD CONNECTOR ASSY;P55A/HCM4215W,UL1185  | ...4     | RZ110       | 2001-000800                             | R-CARBON;5.1KOHM,5%,1/8W,AA,TP,1.8X3.2MM |  |
| ...3     | CNZ01       | 3711-003046                              | CONNECTOR-HEADER;BOX,9P,1R,2.5mm,STRAIGH  | ...4     | RZ111       | 2001-000563                             | R-CARBON;27KOHM,5%,1/8W,AA,TP,1.8X3.2MM  |  |
| ...3     | CNZ02       | 3711-003043                              | CONNECTOR-HEADER;BOX,4P,1R,2.5mm,STRAIGH  | ...4     | RZ112       | 2001-000563                             | R-CARBON;27KOHM,5%,1/8W,AA,TP,1.8X3.2MM  |  |
| ...3     | CNZ03       | 3711-003043                              | CONNECTOR-HEADER;BOX,4P,1R,2.5mm,STRAIGH  | ...4     | RZ113       | 2001-000591                             | R-CARBON;3.3KOHM,5%,1/8W,AA,TP,1.8X3.2MM |  |
| ...3     | CNZ04       | 3711-003043                              | CONNECTOR-HEADER;BOX,4P,1R,2.5mm,STRAIGH  | ...4     | RZ114       | 2001-000857                             | R-CARBON;560OHM,5%,1/8W,AA,TP,1.8X3.2MM  |  |
| ...3     | CNZ05       | 3711-003043                              | CONNECTOR-HEADER;BOX,4P,1R,2.5mm,STRAIGH  | ...4     | RZ115       | 2001-000591                             | R-CARBON;3.3KOHM,5%,1/8W,AA,TP,1.8X3.2MM |  |
| ...3     | CZ101       | BP96-00005A                              | ASSY HEAT SINK P;BP62-00002A,SCREW,STK39  | S.N.A    | ...4        | RZ116                                   | 2001-000857                              | R-CARBON;560OHM,5%,1/8W,AA,TP,1.8X3.2MM  |
| ...4     | CIS         | 1201-001225                              | IC-VIDEO AMP;392,SIP,22P,-,TRIPLE,-,PLAS  | ...4     | RZ117       | 2001-000591                             | R-CARBON;3.3KOHM,5%,1/8W,AA,TP,1.8X3.2MM |  |
| ...4     | CIS         | BP73-00002A                              | SILICON/RUBBER;COMMANDO CG AMP,SILICON    | S.N.A    | ...4        | RZ118                                   | 2001-000857                              | R-CARBON;560OHM,5%,1/8W,AA,TP,1.8X3.2MM  |
| ...4     | CIS         | BP62-00008A                              | HEAT SINK;COMMANDO CG AMP,AL6063,T2.0,W1  | S.N.A    | ...4        | RZ123                                   | 2003-002148                              | R-METAL OXIDE;3.9OHM,2%,2W,AF,TP,3.9X10M |
| ...4     | CIS         | BP62-00002A                              | HEAT SINK;COMMANDO,A1050P,T2.0,W62.0,H14  | S.N.A    | ...4        | RZ124                                   | 2003-002148                              | R-METAL OXIDE;3.9OHM,2%,2W,AF,TP,3.9X10M |
| ...4     | CIS         | 6003-001021                              | SCREW-TAPTITE;RH,+ ,B,M3,L15,ZPC(YEL),SWR | S.N.A    | ...4        | RZ125                                   | 2003-002148                              | R-METAL OXIDE;3.9OHM,2%,2W,AF,TP,3.9X10M |
| ...3     | AA65-30110A | CLAMP-WIRE;ALL MODEL,NYLON 66,V2,-,BLK,P | S.N.A                                     | ...4     | RZ126       | 2003-002148                             | R-METAL OXIDE;3.9OHM,2%,2W,AF,TP,3.9X10M |  |
| ...3     | BP61-00076A | HOLDER-PUSH,A;42W5,NYLON6.6,NATURAL      | S.N.A                                     | ...4     | RZ127       | 2003-002148                             | R-METAL OXIDE;3.9OHM,2%,2W,AF,TP,3.9X10M |  |
| ...3     | BP61-00077A | HOLDER-PUSH,B;42W5,NYLON6.6,NATURAL      | S.N.A                                     | ...4     | RZ128       | 2003-002148                             | R-METAL OXIDE;3.9OHM,2%,2W,AF,TP,3.9X10M |  |
| ...3     | 0202-000187 | SOLDER-WIRE FLUX;-RS60S,D1.2,63Sn/37Pb   | S.N.A                                     | ...4     | RZ129       | 2003-002171                             | R-METAL OXIDE(S);150ohm,5%,2W,AG,TP,3.9x |  |
| ...3     | AA97-07418A | ASSY AUTO;0000                           | S.N.A                                     | ...4     | RZ129A      | 2003-002171                             | R-METAL OXIDE(S);150ohm,5%,2W,AG,TP,3.9x |  |
| ...4     | C866        | 2401-000183                              | C-AL;1000uF,20%,35V,WT,TP,12.5x25,5       | ...4     | RZ130       | 2003-002171                             | R-METAL OXIDE(S);150ohm,5%,2W,AG,TP,3.9x |  |
| ...4     | C869        | 2401-000183                              | C-AL;1000uF,20%,35V,WT,TP,12.5x25,5       | ...4     | RZ130A      | 2003-002171                             | R-METAL OXIDE(S);150ohm,5%,2W,AG,TP,3.9x |  |
| ...4     | CZ108       | 2202-000863                              | C-CERAMIC,MLC-AXIAL;560pF,10%,50V,Y5P,TP  | ...4     | RZ131       | 2003-002171                             | R-METAL OXIDE(S);150ohm,5%,2W,AG,TP,3.9x |  |
| ...4     | CZ109       | 2202-000863                              | C-CERAMIC,MLC-AXIAL;560pF,10%,50V,Y5P,TP  | ...4     | RZ131A      | 2003-002171                             | R-METAL OXIDE(S);150ohm,5%,2W,AG,TP,3.9x |  |
| ...4     | CZ110       | 2202-000863                              | C-CERAMIC,MLC-AXIAL;560pF,10%,50V,Y5P,TP  | ...4     | RZ132       | 2003-002171                             | R-METAL OXIDE(S);150ohm,5%,2W,AG,TP,3.9x |  |
| ...4     | CZ111       | 2202-000205                              | C-CERAMIC,MLC-AXIAL;22pF,5%,50V,SL,TP,1   | ...4     | RZ132A      | 2003-002171                             | R-METAL OXIDE(S);150ohm,5%,2W,AG,TP,3.9x |  |
| ...4     | CZ112       | 2202-000825                              | C-CERAMIC,MLC-AXIAL;680pF,10%,50V,Y5P,TP  | ...4     | RZ133       | 2001-000563                             | R-CARBON;27KOHM,5%,1/8W,AA,TP,1.8X3.2MM  |  |
| ...4     | CZ113       | 2202-000561                              | C-CERAMIC,MLC-RADIAL;680pF,5%,50V,NPO,TP  | ...4     | RZ134       | 2001-000563                             | R-CARBON;27KOHM,5%,1/8W,AA,TP,1.8X3.2MM  |  |
| ...4     | CZ114       | 2202-000561                              | C-CERAMIC,MLC-RADIAL;680pF,5%,50V,NPO,TP  | ...4     | RZ135       | 2001-000563                             | R-CARBON;27KOHM,5%,1/8W,AA,TP,1.8X3.2MM  |  |
| ...4     | CZ115       | 2202-000205                              | C-CERAMIC,MLC-AXIAL;22pF,5%,50V,SL,TP,1   | ...4     | RZ136       | 2001-000591                             | R-CARBON;3.3KOHM,5%,1/8W,AA,TP,1.8X3.2MM |  |
| ...4     | CZ116       | 2202-000825                              | C-CERAMIC,MLC-AXIAL;680pF,10%,50V,Y5P,TP  | ...4     | RZ137       | 2001-000857                             | R-CARBON;560OHM,5%,1/8W,AA,TP,1.8X3.2MM  |  |
| ...4     | CZ117       | 2201-000327                              | C-CERAMIC,DISC;2.2nF,10%,50V,Y5V,TP,6.5x  | ...4     | RZ138       | 2001-000591                             | R-CARBON;3.3KOHM,5%,1/8W,AA,TP,1.8X3.2MM |  |
| ...4     | CZ118       | 2201-000327                              | C-CERAMIC,DISC;2.2nF,10%,50V,Y5V,TP,6.5x  | ...4     | RZ139       | 2001-000857                             | R-CARBON;560OHM,5%,1/8W,AA,TP,1.8X3.2MM  |  |
| ...4     | CZ126       | 2202-000863                              | C-CERAMIC,MLC-AXIAL;560pF,10%,50V,Y5P,TP  | ...4     | RZ140       | 2001-000591                             | R-CARBON;3.3KOHM,5%,1/8W,AA,TP,1.8X3.2MM |  |
| ...4     | CZ127       | 2202-000863                              | C-CERAMIC,MLC-AXIAL;560pF,10%,50V,Y5P,TP  | ...4     | RZ141       | 2001-000857                             | R-CARBON;560OHM,5%,1/8W,AA,TP,1.8X3.2MM  |  |
| ...4     | CZ128       | 2202-000863                              | C-CERAMIC,MLC-AXIAL;560pF,10%,50V,Y5P,TP  | ...4     | RZ142       | 2003-002148                             | R-METAL OXIDE;3.9OHM,2%,2W,AF,TP,3.9X10M |  |
| ...4     | CZ132       | 2202-000205                              | C-CERAMIC,MLC-AXIAL;22pF,5%,50V,SL,TP,1   | ...4     | RZ143       | 2003-002148                             | R-METAL OXIDE;3.9OHM,2%,2W,AF,TP,3.9X10M |  |
| ...4     | CZ133       | 2202-000825                              | C-CERAMIC,MLC-AXIAL;680pF,10%,50V,Y5P,TP  | ...4     | RZ144       | 2003-002148                             | R-METAL OXIDE;3.9OHM,2%,2W,AF,TP,3.9X10M |  |
| ...4     | CZ134       | 2202-000205                              | C-CERAMIC,MLC-AXIAL;22pF,5%,50V,SL,TP,1   | ...4     | RZ145       | 2003-002148                             | R-METAL OXIDE;3.9OHM,2%,2W,AF,TP,3.9X10M |  |
| ...4     | CZ135       | 2202-000825                              | C-CERAMIC,MLC-AXIAL;680pF,10%,50V,Y5P,TP  | ...4     | RZ146       | 2003-002148                             | R-METAL OXIDE;3.9OHM,2%,2W,AF,TP,3.9X10M |  |
| ...4     | CZ136       | 2202-000205                              | C-CERAMIC,MLC-AXIAL;22pF,5%,50V,SL,TP,1   | ...4     | RZ147       | 2003-002148                             | R-METAL OXIDE;3.9OHM,2%,2W,AF,TP,3.9X10M |  |
| ...4     | CZ137       | 2202-000825                              | C-CERAMIC,MLC-AXIAL;680pF,10%,50V,Y5P,TP  | ...4     | RZ148       | 2003-002171                             | R-METAL OXIDE(S);150ohm,5%,2W,AG,TP,3.9x |  |
| ...4     | CZ138       | 2201-000327                              | C-CERAMIC,DISC;2.2nF,10%,50V,Y5V,TP,6.5x  | ...4     | RZ148A      | 2003-002171                             | R-METAL OXIDE(S);150ohm,5%,2W,AG,TP,3.9x |  |
| ...4     | CZ139       | 2201-000327                              | C-CERAMIC,DISC;2.2nF,10%,50V,Y5V,TP,6.5x  | ...4     | RZ149       | 2003-002171                             | R-METAL OXIDE(S);150ohm,5%,2W,AG,TP,3.9x |  |
| ...4     | CZ140       | 2401-000962                              | C-AL;22uF,20%,50V,GP,TP,5x11,5            | ...4     | RZ149A      | 2003-002171                             | R-METAL OXIDE(S);150ohm,5%,2W,AG,TP,3.9x |  |
| ...4     | CZ141       | 2401-000962                              | C-AL;22uF,20%,50V,GP,TP,5x11,5            | △ ...2   | AA96-00156A | ASSY-POWER,CORD;-EP2/YES(US),H/C100MM,K |  |  |
| ...4     | CZ151       | 2202-000121                              | C-CERAMIC,MLC-AXIAL;100pF,10%,50V,Y5P,TP  | ...3     | 3301-001201 | CORE-FERRITE;AE,21x11x32mm,1500,280G    |  |  |

Electrical Parts List

| Loc. No. | Code No.    | Description ; Specification              | Remark                                   | Loc. No. | Code No. | Description ; Specification | Remark                                   |  |
|----------|-------------|--|--|----------|----------|-----------------------------|--|--|
| ...3     | AA61-20284A | HOLDER;P-CORD,PP,-,-,BLK,VO,KE-002       | S.N.A                                    | ...5     | C927     | 2203-000181                 | C-CERAMIC,CHIP;100nF,+80-20%,25V,Y5V,TP, |  |
| ...3     | AA39-10007Y | POWER-CORD,-,EP2/YES,SPT-2 18AWGx2C,2.4m |  | ...5     | C928     | 2203-000181                 | C-CERAMIC,CHIP;100nF,+80-20%,25V,Y5V,TP, |  |
| ...3     | 3811-000401 | WIRE-PVC CU;BCWA,300V,ROLL,17/0.16mm,#22 | S.N.A                                    | ...5     | C929     | 2203-000181                 | C-CERAMIC,CHIP;100nF,+80-20%,25V,Y5V,TP, |  |
| ..2      | AA61-01127A | HOLDER-CHASSIS;COMMANDO,HIPS VO,G4309    | S.N.A                                    | ...5     | C931     | 2203-000189                 | C-CERAMIC,CHIP;100nF,+80-20%,25V,Y5V,TP, |  |
| ..2      | AA94-08264A | ASSY PCB MAIN;MAIN-C2,COMMANDO           |  | ...5     | C932     | 2203-000181                 | C-CERAMIC,CHIP;100nF,+80-20%,25V,Y5V,TP, |  |
| ...3     | C681        | 2401-000737                              | C-AL;2200uF,20%,50V,GP,TP,18x35.5,7      | ...5     | C933     | 2203-000236                 | C-CERAMIC,CHIP;0.1nF,5%,50V,NP0,TP,1608  |  |
| ...3     | C801        | 2401-001068                              | C-AL;3300uF,20%,50V,GP,BK,22x40,10       | ...5     | C934     | 2203-000236                 | C-CERAMIC,CHIP;0.1nF,5%,50V,NP0,TP,1608  |  |
| ...3     | CN901       | 3703-001187                              | CONNECTOR-DIN;64P,2R,FEMALE,STRAIGHT,AUF | ...5     | C935     | 2203-000236                 | C-CERAMIC,CHIP;0.1nF,5%,50V,NP0,TP,1608  |  |
| ...3     | CNW01       | 3703-001150                              | CONNECTOR-DIN;32P,2R,FEMALE,STRAIGHT,AUF | ...5     | C936     | 2402-001042                 | C-AL,SMD;100uF,20%,16V,GP,TP,6.6x6.6x5.4 |  |
| ...3     | CNW02       | 3703-001150                              | CONNECTOR-DIN;32P,2R,FEMALE,STRAIGHT,AUF | ...5     | C937     | 2203-000236                 | C-CERAMIC,CHIP;0.1nF,5%,50V,NP0,TP,1608  |  |
| ...3     | CNZ01       | 3703-001150                              | CONNECTOR-DIN;32P,2R,FEMALE,STRAIGHT,AUF | ...5     | C938     | 2402-001042                 | C-AL,SMD;100uF,20%,16V,GP,TP,6.6x6.6x5.4 |  |
| ...3     | IC601       | AA96-00623E                              | ASSY H/S;SCREW,MAIN,AA62-00056A,TD47265, | S.N.A    | ...5     | C950                        | 2402-000179                              | C-AL,SMD;47uF,20%,16V,GP,TP,6.6x6.6x5.4  |
| ...4     |             | 0205-000129                              | GREASE-SILICON;SC102,JAPAN               | S.N.A    | ...5     | C951                        | 2203-000221                              | C-CERAMIC,CHIP;100nF,20%,50V,Y5V,TP,3216 |
| ...4     |             | 1201-001026                              | IC-POWER AMP;7265,ZIP,11P,19.6MIL,DUAL,1 |          | ...5     | D602                        | 0401-000133                              | DIODE-SWITCHING;RLS4148,100V,200MA,SOD-8 |
| ...4     |             | 6003-000334                              | SCREW-TAPTITE,RH,+,2S,M3,L6,ZPC(YEL),SWR | S.N.A    | ...5     | D901                        | 0401-000133                              | DIODE-SWITCHING;RLS4148,100V,200MA,SOD-8 |
| △        | IC801       | AA62-00056A                              | HEAT SINK PS,-,T1.0,-,41*35*70,D2,-,-,   | S.N.A    | ...5     | D902                        | 0401-000133                              | DIODE-SWITCHING;RLS4148,100V,200MA,SOD-8 |
| ...4     |             | AA96-00475C                              | ASSY H/S;SILICON-OIL,KA278R09,KA7808,AA6 | S.N.A    | ...5     | D905                        | 0401-000133                              | DIODE-SWITCHING;RLS4148,100V,200MA,SOD-8 |
| ...4     |             | 1203-001978                              | IC-VOLTAGE REGULATOR;KA278RA05,TO-220F,4 |          | ...5     | D906                        | 0401-000133                              | DIODE-SWITCHING;RLS4148,100V,200MA,SOD-8 |
| ...4     |             | AA62-00066B                              | HEAT SINK;D2,D3,AL,T1.0,89,70,-,AA62-00  | S.N.A    | ...5     | D920                        | 0401-000133                              | DIODE-SWITCHING;RLS4148,100V,200MA,SOD-8 |
| ...4     |             | 6003-000334                              | SCREW-TAPTITE,RH,+,2S,M3,L6,ZPC(YEL),SWR | S.N.A    | ...5     | D923                        | 0401-000133                              | DIODE-SWITCHING;RLS4148,100V,200MA,SOD-8 |
| ...4     |             | 1203-002003                              | IC-VOLTAGE REGULATOR;278R09,TO-220,4P,-, |          | ...5     | DZ904                       | 0403-001375                              | DIODE-ZENER;RLZ3.6B,3.6-3.845V,500mW,LL- |
| ...4     |             | 1203-000293                              | IC-POSI.FIXED REG.;7808,TO-220,3P,-,PLAS |          | ...5     | DZ905                       | 0403-001375                              | DIODE-ZENER;RLZ3.6B,3.6-3.845V,500mW,LL- |
| ...4     |             | 0205-000129                              | GREASE-SILICON;SC102,JAPAN               | S.N.A    | ...5     | DZ906                       | 0403-001375                              | DIODE-ZENER;RLZ3.6B,3.6-3.845V,500mW,LL- |
| △        | IC802       | 1203-000119                              | IC-NEGA.FIXED REG.;7905,TO-220,3P,-,PLAS |          | ...5     | DZ907                       | 0403-001375                              | DIODE-ZENER;RLZ3.6B,3.6-3.845V,500mW,LL- |
| △        | IC808       | BP96-00020G                              | ASSY HEAT SINK P;AA62-00045B,TAPTITE,SI- | S.N.A    | ...5     | DZ918                       | 0403-001375                              | DIODE-ZENER;RLZ3.6B,3.6-3.845V,500mW,LL- |
| ...4     | CIS         | 0205-000129                              | GREASE-SILICON;SC102,JAPAN               | S.N.A    | ...5     | DZ919                       | 0403-001375                              | DIODE-ZENER;RLZ3.6B,3.6-3.845V,500mW,LL- |
| ...4     | CIS         | 6003-000334                              | SCREW-TAPTITE,RH,+,2S,M3,L6,ZPC(YEL),SWR | S.N.A    | ...5     | DZ920                       | 0403-001375                              | DIODE-ZENER;RLZ3.6B,3.6-3.845V,500mW,LL- |
| ...4     | CIS         | AA62-00045B                              | HEAT SINK;COMMANDO,AL1050,T1.0,H45.0     | S.N.A    | ...5     | IC901                       | 1204-001912                              | IC-DECODER;SDA5550M,P-MQFP,100P,-,PLASTI |
| ...4     | CIS         | 1203-000203                              | IC-POSI.ADJUST REG.;3050,TO-220,5P,-,PLA |          | ...5     | IC902                       | 1103-000180                              | IC-EEPROM;24C16,2Kx8Bit,SOP,8P,150MIL,10 |
| ...3     | JA701       | 3722-001426                              | JACK-PIN;D;9P,3.4mm,NI,BLK,-             |          | ...5     | IC903                       | 1203-002302                              | IC-POSI.FIXED REG.;78RM33D,D-PAK,3P,-,PL |
| ...3     | JA702       | 3722-001871                              | JACK-PIN;5P(9P),8.3MM,NI,GRN/BLU/RED/WH  |          | ...5     | L901                        | 3301-001324                              | CORE-FERRITE BEAD;AB,150HM,2X1.25X0.9MM, |
| ...3     | JA703       | 3722-001163                              | JACK-VHS;4P,12mm,AU,BLK,N                |          | ...5     | L902                        | 3301-001324                              | CORE-FERRITE BEAD;AB,150HM,2X1.25X0.9MM, |
| ...3     | JA704       | 3722-0001870                             | JACK-PIN;5P(10P),8.3MM,NI,GRN/BLU/RED/WH |          | ...5     | L903                        | 3301-001324                              | CORE-FERRITE BEAD;AB,150HM,2X1.25X0.9MM, |
| ...3     | L801        | AA29-00004A                              | FILTER-LINE NOISE;-20UH,3A,AC80-260V,TQ  |          | ...5     | L904                        | 3301-001324                              | CORE-FERRITE BEAD;AB,150HM,2X1.25X0.9MM, |
| ...3     | L802        | AA27-10001C                              | COIL-CHOKE;-100uH,K,-,5.0A,ST,700UH-K/R  |          | ...5     | L905                        | 2703-001245                              | INDUCTOR-SMD;8.2uH,10%,2x1.25x1.25mm     |
| ...3     | TU01        | AA59-00164A                              | MODULE-RF,SPLITTER;-UMX-NT-005,-2IN/30   |          | ...5     | L907                        | 3301-001324                              | CORE-FERRITE BEAD;AB,150HM,2X1.25X0.9MM, |
| ...3     |             | 0202-000187                              | SOLDER-WIRE FLUX;-RS60S,D1.2,63Sn/37Pb   | S.N.A    | ...5     | L920                        | 3301-001324                              | CORE-FERRITE BEAD;AB,150HM,2X1.25X0.9MM, |
| ...3     |             | 0202-001167                              | SOLDER-CREAM;RX3603-2330HO,S45A,PASTE,SN | S.N.A    | ...5     | PCB                         | AA41-00599A                              | PCB-MICOM;FR-4,2L,A,1.6T,180X245,COMMAN  |
| ...3     |             | AA65-30018A                              | CLAMP-WIRE;DONG-A,NYLON-66,-,-,DATL-60   | S.N.A    | ...5     | Q902                        | 0501-000344                              | TR-SMALL SIGNAL;KSC1623-G,NPN,200mW,SOT- |
| ...3     |             | AA65-30104C                              | CLAMP-WIRE;ALL MODEL,NYLON 66,V2,-,NTR,W | S.N.A    | ...5     | Q908                        | 0501-000344                              | TR-SMALL SIGNAL;KSC1623-G,NPN,200mW,SOT- |
| ...3     |             | BP39-00018A                              | LEAD CONNECTOR;P55A/HCM4215W,UL2547#26,U |          | ...5     | Q910                        | 0501-000344                              | TR-SMALL SIGNAL;KSC1623-G,NPN,200mW,SOT- |
| ...3     |             | AA95-02001K                              | ASSY SUB-PCB MICOM;-C2                   |          | ...5     | Q913                        | 0501-000344                              | TR-SMALL SIGNAL;KSC1623-G,NPN,200mW,SOT- |
| ...4     | CN901       | 3703-001175                              | CONNECTOR-DIN;64P,2R,MALE,ANGLE,AU       |          | ...5     | Q914                        | 0501-000344                              | TR-SMALL SIGNAL;KSC1623-G,NPN,200mW,SOT- |
| ...4     | D907        | 0402-000274                              | DIODE-RECTIFIER;UF4004,400V,1A,DO-41,TP  |          | ...5     | Q915                        | 0501-000344                              | TR-SMALL SIGNAL;KSC1623-G,NPN,200mW,SOT- |
| ...4     | IC904       | 1203-001943                              | IC-VOL. DETECTOR;7025,TO-92,3P,-,PLASTIC |          | ...5     | Q916                        | 0501-000344                              | TR-SMALL SIGNAL;KSC1623-G,NPN,200mW,SOT- |
| ...4     | IC905       | 1102-001130                              | IC-EEPROM;M27W201-80F6,256KX8BIT,DIP;32P |          | ...5     | Q917                        | 0501-000344                              | TR-SMALL SIGNAL;KSC1623-G,NPN,200mW,SOT- |
| ...4     | Q901        | 0505-000109                              | FET-SILICON;2N7000,N,60V,200mA,5ohm,400m |          | ...5     | Q920                        | 0501-000344                              | TR-SMALL SIGNAL;KSC1623-G,NPN,200mW,SOT- |
| ...4     | Q903        | 0505-000109                              | FET-SILICON;2N7000,N,60V,200mA,5ohm,400m |          | ...5     | R901                        | 2007-000077                              | R-CHIP;470ohm,5%,1/16W,DA,TP,1608        |
| ...4     | X901        | 2801-004071                              | CRYSTAL-UNIT;6MHZ,30PPM,28-AAM,20PF,400H |          | ...5     | R903                        | 2007-000084                              | R-CHIP;4.7Kohm,5%,1/16W,DA,TP,1608       |
| ...4     |             | 0202-001167                              | SOLDER-CREAM;RX3603-2330HO,S45A,PASTE,SN | S.N.A    | ...5     | R904                        | 2007-000084                              | R-CHIP;4.7Kohm,5%,1/16W,DA,TP,1608       |
| ...4     |             | 0202-000187                              | SOLDER-WIRE FLUX;-RS60S,D1.2,63Sn/37Pb   | S.N.A    | ...5     | R905                        | 2007-000078                              | R-CHIP;1Kohm,5%,1/16W,DA,TP,1608         |
| ...4     |             | AA97-07275A                              | ASSY SMD;1 , , , ,                       | S.N.A    | ...5     | R906                        | 2007-000084                              | R-CHIP;4.7Kohm,5%,1/16W,DA,TP,1608       |
| ...5     | C901        | 2203-000748                              | C-CERAMIC,CHIP;0.03nF,5%,50V,NP0,TP,2012 |          | ...5     | R907                        | 2007-000074                              | R-CHIP;100ohm,5%,1/16W,DA,TP,1608        |
| ...5     | C902        | 2203-000440                              | C-CERAMIC,CHIP;1nF,10%,50V,X7R,TP,1608,- |          | ...5     | R908                        | 2007-000084                              | R-CHIP;4.7Kohm,5%,1/16W,DA,TP,1608       |
| ...5     | C903        | 2203-000357                              | C-CERAMIC,CHIP;0.15nF,5%,50V,NP0,TP,1608 |          | ...5     | R909                        | 2007-000074                              | R-CHIP;100ohm,5%,1/16W,DA,TP,1608        |
| ...5     | C904        | 2203-000440                              | C-CERAMIC,CHIP;1nF,10%,50V,X7R,TP,1608,- |          | ...5     | R911                        | 2007-000076                              | R-CHIP;330ohm,5%,1/16W,DA,TP,1608        |
| ...5     | C905        | 2203-000444                              | C-CERAMIC,CHIP;1nF,10%,50V,X7R,TP,2012,- |          | ...5     | R912                        | 2007-000081                              | R-CHIP;2.7Kohm,5%,1/16W,DA,TP,1608       |
| ...5     | C906        | 2203-000440                              | C-CERAMIC,CHIP;1nF,10%,50V,X7R,TP,1608,- |          | ...5     | R913                        | 2007-000081                              | R-CHIP;2.7Kohm,5%,1/16W,DA,TP,1608       |
| ...5     | C907        | 2203-000181                              | C-CERAMIC,CHIP;100nF,+80-20%,25V,Y5V,TP, |          | ...5     | R914                        | 2007-000123                              | R-CHIP;1.5Kohm,5%,1/16W,DA,TP,1608       |
| ...5     | C908        | 2203-001048                              | C-CERAMIC,CHIP;0.56nF,10%,50V,NP0,TP,201 |          | ...5     | R915                        | 2007-000081                              | R-CHIP;2.7Kohm,5%,1/16W,DA,TP,1608       |
| ...5     | C909        | 2203-000260                              | C-CERAMIC,CHIP;10nF,10%,50V,X7R,TP,2012  |          | ...5     | R916                        | 2007-000074                              | R-CHIP;100ohm,5%,1/16W,DA,TP,1608        |
| ...5     | C910        | 2203-000748                              | C-CERAMIC,CHIP;0.03nF,5%,50V,NP0,TP,2012 |          | ...5     | R917                        | 2007-000074                              | R-CHIP;100ohm,5%,1/16W,DA,TP,1608        |
| ...5     | C911        | 2402-001049                              | C-AL,CHIP;10uF,20%,16V,GP,TP,3.3x3.3x5.4 |          | ...5     | R918                        | 2007-000074                              | R-CHIP;100ohm,5%,1/16W,DA,TP,1608        |
| ...5     | C912        | 2402-001049                              | C-AL,CHIP;10uF,20%,16V,GP,TP,3.3x3.3x5.4 |          | ...5     | R921                        | 2007-000078                              | R-CHIP;1Kohm,5%,1/16W,DA,TP,1608         |
| ...5     | C913        | 2402-001042                              | C-AL,SMD;100uF,20%,16V,GP,TP,6.6x6.6x5.4 |          | ...5     | R922                        | 2007-000074                              | R-CHIP;100ohm,5%,1/16W,DA,TP,1608        |
| ...5     | C914        | 2203-000181                              | C-CERAMIC,CHIP;100nF,+80-20%,25V,Y5V,TP, |          | ...5     | R923                        | 2007-000074                              | R-CHIP;100ohm,5%,1/16W,DA,TP,1608        |
| ...5     | C915        | 2402-001042                              | C-AL,SMD;100uF,20%,16V,GP,TP,6.6x6.6x5.4 |          | ...5     | R924                        | 2007-000078                              | R-CHIP;1Kohm,5%,1/16W,DA,TP,1608         |
| ...5     | C916        | 2203-000181                              | C-CERAMIC,CHIP;100nF,+80-20%,25V,Y5V,TP, |          | ...5     | R925                        | 2007-000078                              | R-CHIP;1Kohm,5%,1/16W,DA,TP,1608         |
| ...5     | C917        | 2402-001049                              | C-AL,CHIP;10uF,20%,16V,GP,TP,3.3x3.3x5.4 |          | ...5     | R926                        | 2007-000097                              | R-CHIP;47Kohm,5%,1/16W,DA,TP,1608        |
| ...5     | C918        | 2402-001042                              | C-AL,SMD;100uF,20%,16V,GP,TP,6.6x6.6x5.4 |          | ...5     | R927                        | 2007-000084                              | R-CHIP;4.7Kohm,5%,1/16W,DA,TP,1608       |
| ...5     | C919        | 2203-000181                              | C-CERAMIC,CHIP;100nF,+80-20%,25V,Y5V,TP, |          | ...5     | R928                        | 2007-000084                              | R-CHIP;4.7Kohm,5%,1/16W,DA,TP,1608       |
| ...5     | C920        | 2203-000181                              | C-CERAMIC,CHIP;100nF,+80-20%,25V,Y5V,TP, |          | ...5     | R930                        | 2007-000078                              | R-CHIP;1Kohm,5%,1/16W,DA,TP,1608         |
| ...5     | C921        | 2402-001042                              | C-AL,SMD;100uF,20%,16V,GP,TP,6.6x6.6x5.4 |          | ...5     | R933                        | 2007-000078                              | R-CHIP;1Kohm,5%,1/16W,DA,TP,1608         |
| ...5     | C922        | 2203-005809                              | C-CERAMIC,CHIP;1000nF,10%,16V,X7R,TP,201 |          | ...5     | R934                        | 2007-000074                              | R-CHIP;100ohm,5%,1/16W,DA,TP,1608        |
| ...5     | C924        | 2203-000181                              | C-CERAMIC,CHIP;100nF,+80-20%,25V,Y5V,TP, |          | ...5     | R936                        | 2007-000078                              | R-CHIP;1Kohm,5%,1/16W,DA,TP,1608         |
| ...5     | C925        | 2203-000181                              | C-CERAMIC,CHIP;100nF,+80-20%,25V,Y5V,TP, |          | ...5     | R939                        | 2007-000074                              | R-CHIP;100ohm,5%,1/16W,DA,TP,1608        |
| ...5     | C926        | 2203-000181                              | C-CERAMIC,CHIP;100nF,+80-20%,25V,Y5V,TP, |          | ...5     | R940                        | 2007-000074                              | R-CHIP;100ohm,5%,1/16W,DA,TP,1608        |

| Loc. No. | Code No.    | Description ; Specification             | Remark                                   | Loc. No. | Code No. | Description ; Specification | Remark                                    |                                   |
|----------|-------------|---|--|----------|----------|-----------------------------|---|-----------------------------------|
| .....5   | R941        | 2007-000123                             | R-CHIP;1.5Kohm,5%,1/16W,DA,TP,1608       | .....5   | C632     | 2401-000480                 | C-AL;10uF,20%,50V,GP,TP,5x11,5            |                                   |
| .....5   | R942        | 2007-000123                             | R-CHIP;1.5Kohm,5%,1/16W,DA,TP,1608       | .....5   | C633     | 2401-000480                 | C-AL;10uF,20%,50V,GP,TP,5x11,5            |                                   |
| .....5   | R944        | 2007-000090                             | R-CHIP;10KOHM,5%,1/16W,DA,TP,1608        | .....5   | C639     | 2401-000962                 | C-AL;22uF,20%,50V,GP,TP,5x11,5            |                                   |
| .....5   | R945        | 2007-001167                             | R-CHIP;75ohm,5%,1/16W,DA,TP,1608         | .....5   | C640     | 2401-000962                 | C-AL;22uF,20%,50V,GP,TP,5x11,5            |                                   |
| .....5   | R946        | 2007-001167                             | R-CHIP;75ohm,5%,1/16W,DA,TP,1608         | .....5   | C642     | 2401-000027                 | C-AL;4.7uF,20%,50V,GP,TP,5x11,5           |                                   |
| .....5   | R948        | 2007-001167                             | R-CHIP;75ohm,5%,1/16W,DA,TP,1608         | .....5   | C643     | 2401-000027                 | C-AL;4.7uF,20%,50V,GP,TP,5x11,5           |                                   |
| .....5   | R949        | 2007-001167                             | R-CHIP;75ohm,5%,1/16W,DA,TP,1608         | .....5   | C644     | 2401-000027                 | C-AL;4.7uF,20%,50V,GP,TP,5x11,5           |                                   |
| .....5   | R950        | 2007-001167                             | R-CHIP;75ohm,5%,1/16W,DA,TP,1608         | .....5   | C645     | 2401-001989                 | C-AL;4.7uF,20%,50V,GP,TP,5x11,5           |                                   |
| .....5   | R951        | 2007-001167                             | R-CHIP;75ohm,5%,1/16W,DA,TP,1608         | .....5   | C646     | 2401-001989                 | C-AL;4.7uF,20%,50V,GP,TP,5x11,5           |                                   |
| .....5   | R952        | 2007-000074                             | R-CHIP;100ohm,5%,1/16W,DA,TP,1608        | .....5   | C647     | 2401-001989                 | C-AL;4.7uF,20%,50V,GP,TP,5x11,5           |                                   |
| .....5   | R953        | 2007-000074                             | R-CHIP;100ohm,5%,1/16W,DA,TP,1608        | .....5   | C648     | 2401-001989                 | C-AL;4.7uF,20%,50V,GP,TP,5x11,5           |                                   |
| .....5   | R954        | 2007-000084                             | R-CHIP;4.7Kohm,5%,1/16W,DA,TP,1608       | .....5   | C649     | 2401-001989                 | C-AL;4.7uF,20%,50V,GP,TP,5x11,5           |                                   |
| .....5   | R955        | 2007-000084                             | R-CHIP;4.7Kohm,5%,1/16W,DA,TP,1608       | .....5   | C650     | 2401-001989                 | C-AL;4.7uF,20%,50V,GP,TP,5x11,5           |                                   |
| .....5   | R956        | 2007-000074                             | R-CHIP;100ohm,5%,1/16W,DA,TP,1608        | .....5   | C652     | 2401-000480                 | C-AL;10uF,20%,50V,GP,TP,5x11,5            |                                   |
| .....5   | R957        | 2007-000090                             | R-CHIP;10KOHM,5%,1/16W,DA,TP,1608        | .....5   | C656     | 2401-000480                 | C-AL;10uF,20%,50V,GP,TP,5x11,5            |                                   |
| .....5   | R958        | 2007-000084                             | R-CHIP;4.7Kohm,5%,1/16W,DA,TP,1608       | .....5   | C662     | 2401-002619                 | C-AL;47uF,20%,25V,GP,TP,5x11,5            |                                   |
| .....5   | R959        | 2007-000070                             | R-CHIP;0ohm,5%,1/16W,DA,TP,1608          | .....5   | C664     | 2401-000480                 | C-AL;10uF,20%,50V,GP,TP,5x11,5            |                                   |
| .....5   | R960        | 2007-000070                             | R-CHIP;0ohm,5%,1/16W,DA,TP,1608          | .....5   | C668     | 2401-000480                 | C-AL;10uF,20%,50V,GP,TP,5x11,5            |                                   |
| .....5   | R961        | 2007-000939                             | R-CHIP;47Kohm,1%,1/16W,DA,TP,1608        | .....5   | C669     | 2401-000480                 | C-AL;10uF,20%,50V,GP,TP,5x11,5            |                                   |
| .....5   | R962        | 2007-000583                             | R-CHIP;22Kohm,1%,1/16W,DA,TP,1608        | .....5   | C670     | 2401-000480                 | C-AL;10uF,20%,50V,GP,TP,5x11,5            |                                   |
| .....5   | R963        | 2007-000077                             | R-CHIP;470ohm,5%,1/16W,DA,TP,1608        | .....5   | C674     | 2401-000480                 | C-AL;10uF,20%,50V,GP,TP,5x11,5            |                                   |
| .....5   | R964        | 2007-000070                             | R-CHIP;0ohm,5%,1/16W,DA,TP,1608          | .....5   | C675     | 2401-000480                 | C-AL;10uF,20%,50V,GP,TP,5x11,5            |                                   |
| .....5   | R965        | 2007-000070                             | R-CHIP;0ohm,5%,1/16W,DA,TP,1608          | .....5   | C676     | 2401-000480                 | C-AL;10uF,20%,50V,GP,TP,5x11,5            |                                   |
| .....5   | R966        | 2007-000931                             | R-CHIP;4700HM,5%,1/10W,DA,TP,2012        | .....5   | C679     | 2401-000603                 | C-AL;1uF,20%,50V,GP,TP,5x11,5             |                                   |
| .....5   | R969        | 2007-000074                             | R-CHIP;100ohm,5%,1/16W,DA,TP,1608        | .....5   | C680     | 2401-000603                 | C-AL;1uF,20%,50V,GP,TP,5x11,5             |                                   |
| .....5   | R970        | 2007-000074                             | R-CHIP;100ohm,5%,1/16W,DA,TP,1608        | .....5   | C682     | 2305-000665                 | C-FILM,MPEF;100nF,5%,63V,TP,7.5x4.0x5.0mm |                                   |
| .....5   | R971        | 2007-000084                             | R-CHIP;4.7Kohm,5%,1/16W,DA,TP,1608       | .....5   | C683     | 2401-000962                 | C-AL;22uF,20%,50V,GP,TP,5x11,5            |                                   |
| .....5   | R972        | 2007-000074                             | R-CHIP;100ohm,5%,1/16W,DA,TP,1608        | .....5   | C684     | 2401-000603                 | C-AL;1uF,20%,50V,GP,TP,5x11,5             |                                   |
| .....5   | R974        | 2007-000078                             | R-CHIP;1Kohm,5%,1/16W,DA,TP,1608         | .....5   | C685     | 2401-001192                 | C-AL;33uF,20%,50V,GP,TP,6.3x11,5          |                                   |
| .....5   | R975        | 2007-000121                             | R-CHIP;820ohm,5%,1/16W,DA,TP,1608        | .....5   | C686     | 2401-000192                 | C-AL;1000uF,20%,50V,GP,TP,16x25,7,5       |                                   |
| .....5   | R976        | 2007-000084                             | R-CHIP;4.7Kohm,5%,1/16W,DA,TP,1608       | .....5   | C687     | 2305-000665                 | C-FILM,MPEF;100nF,5%,63V,TP,7.5x4.0x5.0mm |                                   |
| .....5   | R978        | 2007-000084                             | R-CHIP;4.7Kohm,5%,1/16W,DA,TP,1608       | .....5   | C688     | 2401-000192                 | C-AL;1000uF,20%,50V,GP,TP,16x25,7,5       |                                   |
| .....5   | R979        | 2007-000074                             | R-CHIP;100ohm,5%,1/16W,DA,TP,1608        | .....5   | C689     | 2305-000665                 | C-FILM,MPEF;100nF,5%,63V,TP,7.5x4.0x5.0mm |                                   |
| .....5   | R980        | 2007-000084                             | R-CHIP;4.7Kohm,5%,1/16W,DA,TP,1608       | .....5   | C690     | 2401-000027                 | C-AL;4.7uF,20%,50V,GP,TP,5x11,5           |                                   |
| .....5   | R981        | 2007-000070                             | R-CHIP;0ohm,5%,1/16W,DA,TP,1608          | .....5   | C691     | 2401-002300                 | C-AL;47uF,20%,50V,GP,TP,6.3x11,5          |                                   |
| .....5   | R982        | 2007-000084                             | R-CHIP;4.7Kohm,5%,1/16W,DA,TP,1608       | .....5   | C694     | 2301-000192                 | C-FILM,PEF;1nF,5%,50V,TP,5.3x10mm,5mm     |                                   |
| .....5   | R983        | 2007-000084                             | R-CHIP;4.7Kohm,5%,1/16W,DA,TP,1608       | .....5   | C695     | 2301-000192                 | C-FILM,PEF;1nF,5%,50V,TP,5.3x10mm,5mm     |                                   |
| .....5   | R985        | 2007-000084                             | R-CHIP;4.7Kohm,5%,1/16W,DA,TP,1608       | .....5   | C706     | 2401-002619                 | C-AL;47uF,20%,25V,GP,TP,5x11,5            |                                   |
| .....5   | R986        | 2007-000084                             | R-CHIP;4.7Kohm,5%,1/16W,DA,TP,1608       | .....5   | C716     | 2401-001840                 | C-AL;100uF,20%,16V,GP,TP,6.3x11,5         |                                   |
| .....5   | R987        | 2007-000090                             | R-CHIP;10KOHM,5%,1/16W,DA,TP,1608        | .....5   | C720     | 2401-002144                 | C-AL;47uF,20%,16V,GP,TP,5x11,5            |                                   |
| .....5   | R988        | 2007-000290                             | R-CHIP;100OHM,5%,1/10W,DA,TP,2012        | .....5   | C802     | 2401-000471                 | C-AL;10uF,20%,50V,GP,TP,5x11,5mm          |                                   |
| .....3   | AA63-00396B | SHIELD CASE-TOP;PRJT,P54A,SPT,TO.5,-,-, | S.N.A                                    | .....5   | C803     | 2401-001840                 | C-AL;100uF,20%,16V,GP,TP,6.3x11,5         |                                   |
| .....3   | AA63-00397B | SHIELD CASE-BOT;PRJT,P54A,SPT,TO.5,-,-, | S.N.A                                    | .....5   | C806     | 2401-000360                 | C-AL;100uF,20%,50V,GP,TP,8x11,5,5         |                                   |
| .....3   | AA39-20010B | LEAD CONNECTOR-ASSY;1P,YFH800-01,S,500, |  | .....5   | C808     | 2401-002459                 | C-AL;220uF,20%,25V,LZ,TP,10x16,5          |                                   |
| .....3   | AA97-07560J | JASSY ROBOT;                            | S.N.A                                    | .....5   | C809     | 2401-002459                 | C-AL;220uF,20%,25V,LZ,TP,10x16,5          |                                   |
| .....4   | CN801       | 3711-003975                             | CONNECTOR-HEADER;BOX,14P,1R,2.5mm,STRAIG | .....5   | C812     | 2401-002459                 | C-AL;220uF,20%,25V,LZ,TP,10x16,5          |                                   |
| .....4   | CN802       | 3711-004946                             | CONNECTOR-HEADER;BOX,15P,1R,2.5MM,STRAIG | .....5   | C813     | 2401-002459                 | C-AL;220uF,20%,25V,LZ,TP,10x16,5          |                                   |
| .....4   | CN902       | 3711-003973                             | CONNECTOR-HEADER;BOX,11P,1R,2.5mm,STRAIG | .....5   | C816     | 2401-002459                 | C-AL;220uF,20%,25V,LZ,TP,10x16,5          |                                   |
| .....4   | CNY01       | 3711-003641                             | CONNECTOR-HEADER;BOX,12P,1R,2.5mm,STRAIG | .....5   | C817     | 2401-002459                 | C-AL;220uF,20%,25V,LZ,TP,10x16,5          |                                   |
| .....4   | CNZ02       | 3711-003046                             | CONNECTOR-HEADER;BOX,9P,1R,2.5mm,STRAIGH | .....5   | C819     | 2401-001840                 | C-AL;100uF,20%,16V,GP,TP,6.3x11,5         |                                   |
| .....4   | IC807       | 1203-000165                             | IC-POSILADJUST REG.;78R12,TO-220,4P,-,PL | .....5   | C822     | 2401-001840                 | C-AL;100uF,20%,16V,GP,TP,6.3x11,5         |                                   |
| .....4   | TU02        | AA40-00041A                             | TUNER-F/S;TCPN3081PC09C(S),NTSC,181CH,45 | .....5   | C823     | 2401-002463                 | C-AL;470uF,20%,16V,GP,TP,8x11,5,5         |                                   |
| .....4   | TU04        | AA40-00041A                             | TUNER-F/S;TCPN3081PC09C(S),NTSC,181CH,45 | .....5   | C826     | 2401-002619                 | C-AL;47uF,20%,25V,GP,TP,5x11,5            |                                   |
| .....4   |             | AA97-07422A                             | ASSY AUTO;0000                           | S.N.A    | .....5   | C827                        | 2401-000832                               | C-AL;220uF,20%,25V,GP,TP,8x11,5,5 |
| .....5   | C102        | 2401-000302                             | C-AL;100uF,20%,25V,GP,TP,6.3x11,5        | .....5   | C830     | 2401-001397                 | C-AL;470uF,20%,25V,GP,TP,10x16,5          |                                   |
| .....5   | C104        | 2401-000039                             | C-AL;1000uF,20%,16V,GP,TP,10x16,5        | .....5   | C831     | 2401-002300                 | C-AL;47uF,20%,50V,GP,TP,6.3x11,5          |                                   |
| .....5   | C106        | 2401-001513                             | C-AL;47uF,20%,16V,WT,TP,5x11,5           | .....5   | C832     | 2401-000039                 | C-AL;1000uF,20%,16V,GP,TP,10x16,5         |                                   |
| .....5   | C108        | 2401-000603                             | C-AL;1uF,20%,50V,GP,TP,5x11,5            | .....5   | C834     | 2401-002594                 | C-AL;220uF,20%,16V,GP,TP,8x11,5,5         |                                   |
| .....5   | C111        | 2401-002463                             | C-AL;470uF,20%,16V,GP,TP,8x11,5,5        | .....5   | C901     | 2401-002619                 | C-AL;47uF,20%,25V,GP,TP,5x11,5            |                                   |
| .....5   | C113        | 2401-000603                             | C-AL;1uF,20%,50V,GP,TP,5x11,5            | .....5   | C903     | 2401-002619                 | C-AL;47uF,20%,25V,GP,TP,5x11,5            |                                   |
| .....5   | C124        | 2401-000962                             | C-AL;22uF,20%,50V,GP,TP,5x11,5           | .....5   | CN101    | 3711-002642                 | CONNECTOR-HEADER;BOX,3P,1R,2.5mm,STRAIGH  |                                   |
| .....5   | C125        | 2401-000962                             | C-AL;22uF,20%,50V,GP,TP,5x11,5           | .....5   | CN201    | 3711-002645                 | CONNECTOR-HEADER;BOX,6P,1R,2.5mm,STRAIGH  |                                   |
| .....5   | C134        | 2401-000962                             | C-AL;22uF,20%,50V,GP,TP,5x11,5           | .....5   | CN601    | 3711-002643                 | CONNECTOR-HEADER;BOX,4P,1R,2.5mm,STRAIGH  |                                   |
| .....5   | C136        | 2401-000962                             | C-AL;22uF,20%,50V,GP,TP,5x11,5           | .....5   | CN903    | 3711-002642                 | CONNECTOR-HEADER;BOX,3P,1R,2.5mm,STRAIGH  |                                   |
| .....5   | C139        | 2401-000962                             | C-AL;22uF,20%,50V,GP,TP,5x11,5           | .....5   | D601     | 0401-000005                 | DIODE-SWITCHING;1N4148,100V,200mA,DO-35,  |                                   |
| .....5   | C147        | 2401-000480                             | C-AL;10uF,20%,50V,GP,TP,5x11,5           | .....5   | D604     | 0401-000005                 | DIODE-SWITCHING;1N4148,100V,200mA,DO-35,  |                                   |
| .....5   | C601        | 2401-000480                             | C-AL;10uF,20%,50V,GP,TP,5x11,5           | .....5   | D605     | 0401-000005                 | DIODE-SWITCHING;1N4148,100V,200mA,DO-35,  |                                   |
| .....5   | C604        | 2401-000480                             | C-AL;10uF,20%,50V,GP,TP,5x11,5           | .....5   | D606     | 0402-000546                 | DIODE-RECTIFIER;TVR10G,400V,1.0A,DO-41,T  |                                   |
| .....5   | C607        | 2401-000962                             | C-AL;22uF,20%,50V,GP,TP,5x11,5           | .....5   | D607     | 0401-000005                 | DIODE-SWITCHING;1N4148,100V,200mA,DO-35,  |                                   |
| .....5   | C609        | 2401-000962                             | C-AL;22uF,20%,50V,GP,TP,5x11,5           | .....5   | D608     | 0401-000005                 | DIODE-SWITCHING;1N4148,100V,200mA,DO-35,  |                                   |
| .....5   | C610        | 2401-000302                             | C-AL;100uF,20%,25V,GP,TP,6.3x11,5        | .....5   | D609     | 0401-000005                 | DIODE-SWITCHING;1N4148,100V,200mA,DO-35,  |                                   |
| .....5   | C612        | 2401-000962                             | C-AL;22uF,20%,50V,GP,TP,5x11,5           | .....5   | DZ605    | 0403-001039                 | DIODE-ZENER;MA2560,56V,52-60V,1W,DO-41,T  |                                   |
| .....5   | C617        | 2401-000962                             | C-AL;22uF,20%,50V,GP,TP,5x11,5           | .....5   | DZ606    | 0403-001325                 | DIODE-ZENER;MTZJ15C,14.35-15.09V,500mW,D  |                                   |
| .....5   | C620        | 2401-000360                             | C-AL;100uF,20%,50V,GP,TP,8x11,5,5        | .....5   | DZ607    | 0403-001319                 | DIODE-ZENER;MTZJ4.7C,4.68-4.93V,500mW,DO  |                                   |
| .....5   | C629        | 2401-000962                             | C-AL;22uF,20%,50V,GP,TP,5x11,5           | .....5   | DZ801    | 0403-000700                 | DIODE-ZENER;TZP33A,33V,31-35V,1W,DO-41,T  |                                   |
| .....5   | C630        | 2401-000962                             | C-AL;22uF,20%,50V,GP,TP,5x11,5           | .....5   | GT01     | AA60-40014A                 | PIN-GT,ASSY;1P,-,-,AUTO                   |                                   |
| .....5   | C631        | 2401-000480                             | C-AL;10uF,20%,50V,GP,TP,5x11,5           | .....5   | GT02     | AA60-40014A                 | PIN-GT,ASSY;1P,-,-,AUTO                   |                                   |

Electrical Parts List

| Loc. No. | Code No. | Description ; Specification                           | Remark | Loc. No. | Code No. | Description ; Specification                          | Remark |
|----------|----------|---|--------|----------|----------|--|--------|
| .....5   | G T03    | AA60-40014A PIN-GT,ASSY;1P,-,AUTO                     | S.N.A  | .....6   | C 114    | 2203-000236 C-CERAMIC,CHIP;0.1nF,5%,50V,NPO,TP,1608  |        |
| .....5   | L101     | 2701-000115 INDUCTOR-AXIAL;10uH,10%,3x7mm             |        | .....6   | C 115    | 2203-000236 C-CERAMIC,CHIP;0.1nF,5%,50V,NPO,TP,1608  |        |
| .....5   | L102     | 2701-001040 INDUCTOR-AXIAL;10uH,10%,4.5x14mm          |        | .....6   | C 116    | 2203-000236 C-CERAMIC,CHIP;0.1nF,5%,50V,NPO,TP,1608  |        |
| .....5   | L103     | 2701-000115 INDUCTOR-AXIAL;10uH,10%,3x7mm             |        | .....6   | C 117    | 2203-000236 C-CERAMIC,CHIP;0.1nF,5%,50V,NPO,TP,1608  |        |
| .....5   | L104     | 2701-000115 INDUCTOR-AXIAL;10uH,10%,3x7mm             |        | .....6   | C 120    | 2203-000236 C-CERAMIC,CHIP;0.1nF,5%,50V,NPO,TP,1608  |        |
| .....5   | L105     | 2701-000106 INDUCTOR-AXIAL;1.5uH,10%,3x7mm            |        | .....6   | C 121    | 2203-000236 C-CERAMIC,CHIP;0.1nF,5%,50V,NPO,TP,1608  |        |
| .....5   | L106     | 2701-000115 INDUCTOR-AXIAL;10uH,10%,3x7mm             |        | .....6   | C 126    | 2203-000236 C-CERAMIC,CHIP;0.1nF,5%,50V,NPO,TP,1608  |        |
| .....5   | L107     | 2701-000114 INDUCTOR-AXIAL;10uH,10%,2.5x3.4mm         |        | .....6   | C 127    | 2203-000236 C-CERAMIC,CHIP;0.1nF,5%,50V,NPO,TP,1608  |        |
| .....5   | L108     | 2701-000114 INDUCTOR-AXIAL;10uH,10%,2.5x3.4mm         |        | .....6   | C 140    | 2203-000236 C-CERAMIC,CHIP;0.1nF,5%,50V,NPO,TP,1608  |        |
| .....5   | L111     | 2701-000114 INDUCTOR-AXIAL;10uH,10%,2.5x3.4mm         |        | .....6   | C 141    | 2203-000236 C-CERAMIC,CHIP;0.1nF,5%,50V,NPO,TP,1608  |        |
| .....5   | L112     | 2701-000114 INDUCTOR-AXIAL;10uH,10%,2.5x3.4mm         |        | .....6   | C 142    | 2203-000236 C-CERAMIC,CHIP;0.1nF,5%,50V,NPO,TP,1608  |        |
| .....5   | L113     | 2701-000114 INDUCTOR-AXIAL;10uH,10%,2.5x3.4mm         |        | .....6   | C 143    | 2203-000236 C-CERAMIC,CHIP;0.1nF,5%,50V,NPO,TP,1608  |        |
| .....5   | L114     | 2701-000114 INDUCTOR-AXIAL;10uH,10%,2.5x3.4mm         |        | .....6   | C 145    | 2203-000236 C-CERAMIC,CHIP;0.1nF,5%,50V,NPO,TP,1608  |        |
| .....5   | L119     | 2701-000114 INDUCTOR-AXIAL;10uH,10%,2.5x3.4mm         |        | .....6   | C 146    | 2203-000236 C-CERAMIC,CHIP;0.1nF,5%,50V,NPO,TP,1608  |        |
| .....5   | L120     | 2701-000114 INDUCTOR-AXIAL;10uH,10%,2.5x3.4mm         |        | .....6   | C 602    | 2203-000189 C-CERAMIC,CHIP;100nF,+80-20%,25V,Y5V,TP  |        |
| .....5   | L121     | 2701-000114 INDUCTOR-AXIAL;10uH,10%,2.5x3.4mm         |        | .....6   | C 603    | 2203-005590 C-CERAMIC,CHIP;330NF,10%,16V,X7R,TP,2012 |        |
| .....5   | L122     | 2701-000114 INDUCTOR-AXIAL;10uH,10%,2.5x3.4mm         |        | .....6   | C 605    | 2203-000440 C-CERAMIC,CHIP;1nF,10%,50V,X7R,TP,1608,- |        |
| .....5   | L123     | 2701-000114 INDUCTOR-AXIAL;10uH,10%,2.5x3.4mm         |        | .....6   | C 606    | 2203-000440 C-CERAMIC,CHIP;1nF,10%,50V,X7R,TP,1608,- |        |
| .....5   | L124     | 2701-000114 INDUCTOR-AXIAL;10uH,10%,2.5x3.4mm         |        | .....6   | C 608    | 2203-000140 C-CERAMIC,CHIP;1.5nF,10%,50V,X7R,TP,1608 |        |
| .....5   | L605     | 3301-000287 CORE-FERRITE BEAD;AA,3.5x1.0x6.0mm,1500,  |        | .....6   | C 611    | 2203-000440 C-CERAMIC,CHIP;1nF,10%,50V,X7R,TP,1608,- |        |
| .....5   | L606     | 3301-000287 CORE-FERRITE BEAD;AA,3.5x1.0x6.0mm,1500,  |        | .....6   | C 613    | 2203-000440 C-CERAMIC,CHIP;1nF,10%,50V,X7R,TP,1608,- |        |
| .....5   | L703     | 2701-000115 INDUCTOR-AXIAL;10uH,10%,3x7mm             |        | .....6   | C 614    | 2203-000140 C-CERAMIC,CHIP;1.5nF,10%,50V,X7R,TP,1608 |        |
| .....5   | L705     | 2701-001030 INDUCTOR-AXIAL;43uH,10%,5x14mm            |        | .....6   | C 619    | 2203-000189 C-CERAMIC,CHIP;100nF,+80-20%,25V,Y5V,TP  |        |
| .....5   | L706     | 2701-001030 INDUCTOR-AXIAL;43uH,10%,5x14mm            |        | .....6   | C 634    | 2203-000189 C-CERAMIC,CHIP;100nF,+80-20%,25V,Y5V,TP  |        |
| .....5   | Q601     | 0501-000389 TR-SMALL SIGNAL;KSC815,NPN,400mW,TO-92,T  |        | .....6   | C 635    | 2203-001211 C-CERAMIC,CHIP;8.2nF,10%,50V,X7R,TP,1608 |        |
| .....5   | Q602     | 0501-000389 TR-SMALL SIGNAL;KSC815,NPN,400mW,TO-92,T  |        | .....6   | C 636    | 2203-001211 C-CERAMIC,CHIP;8.2nF,10%,50V,X7R,TP,1608 |        |
| .....5   | Q603     | 0501-000389 TR-SMALL SIGNAL;KSC815,NPN,400mW,TO-92,T  |        | .....6   | C 637    | 2203-001211 C-CERAMIC,CHIP;8.2nF,10%,50V,X7R,TP,1608 |        |
| .....5   | R658     | 2001-000812 R-CARBON;5.6KOHM,5%,1/8W,AA,TP,1.8X3.2MM  |        | .....6   | C 638    | 2203-001211 C-CERAMIC,CHIP;8.2nF,10%,50V,X7R,TP,1608 |        |
| .....5   | R659     | 2001-000734 R-CARBON;4.7KOHM,5%,1/8W,AA,TP,1.8X3.2MM  |        | .....6   | C 641    | 2203-000189 C-CERAMIC,CHIP;100nF,+80-20%,25V,Y5V,TP  |        |
| .....5   | R660     | 2001-000734 R-CARBON;4.7KOHM,5%,1/8W,AA,TP,1.8X3.2MM  |        | .....6   | C 651    | 2203-000189 C-CERAMIC,CHIP;100nF,+80-20%,25V,Y5V,TP  |        |
| .....5   | R661     | 2001-000734 R-CARBON;4.7KOHM,5%,1/8W,AA,TP,1.8X3.2MM  |        | .....6   | C 653    | 2203-000332 C-CERAMIC,CHIP;0.012nF,5%,50V,NPO,TP,160 |        |
| .....5   | R662     | 2001-000660 R-CARBON;33KOHM,5%,1/8W,AA,TP,1.8X3.2MM   |        | .....6   | C 654    | 2203-000332 C-CERAMIC,CHIP;0.012nF,5%,50V,NPO,TP,160 |        |
| .....5   | R663     | 2001-000007 R-CARBON;3KOHM,5%,1/8W,AA,TP,1.8X3.2MM    |        | .....6   | C 655    | 2203-001071 C-CERAMIC,CHIP;0.056nF,5%,50V,NPO,TP,160 |        |
| .....5   | R664     | 2001-000780 R-CARBON;470OHM,5%,1/8W,AA,TP,1.8X3.2MM   |        | .....6   | C 657    | 2203-000189 C-CERAMIC,CHIP;100nF,+80-20%,25V,Y5V,TP  |        |
| .....5   | R665     | 2001-000273 R-CARBON;100KOHM,5%,1/8W,AA,TP,1.8X3.2MM  |        | .....6   | C 658    | 2203-001071 C-CERAMIC,CHIP;0.056nF,5%,50V,NPO,TP,160 |        |
| .....5   | R666     | 2001-000734 R-CARBON;4.7KOHM,5%,1/8W,AA,TP,1.8X3.2MM  |        | .....6   | C 659    | 2203-001071 C-CERAMIC,CHIP;0.056nF,5%,50V,NPO,TP,160 |        |
| .....5   | R667     | 2001-000290 R-CARBON;10KOHM,5%,1/8W,AA,TP,1.8X3.2MM   |        | .....6   | C 660    | 2203-000236 C-CERAMIC,CHIP;0.1nF,5%,50V,NPO,TP,1608  |        |
| .....5   | R668     | 2001-000290 R-CARBON;10KOHM,5%,1/8W,AA,TP,1.8X3.2MM   |        | .....6   | C 661    | 2203-000236 C-CERAMIC,CHIP;0.1nF,5%,50V,NPO,TP,1608  |        |
| .....5   | R669     | 2001-000290 R-CARBON;10KOHM,5%,1/8W,AA,TP,1.8X3.2MM   |        | .....6   | C 663    | 2203-000189 C-CERAMIC,CHIP;100nF,+80-20%,25V,Y5V,TP  |        |
| .....5   | R670     | 2001-000411 R-CARBON;18KOHM,5%,1/8W,AA,TP,1.8X3.2MM   |        | .....6   | C 701    | 2203-005590 C-CERAMIC,CHIP;330NF,10%,16V,X7R,TP,2012 |        |
| .....5   | R671     | 2001-000734 R-CARBON;4.7KOHM,5%,1/8W,AA,TP,1.8X3.2MM  |        | .....6   | C 702    | 2203-005590 C-CERAMIC,CHIP;330NF,10%,16V,X7R,TP,2012 |        |
| .....5   | R672     | 2001-000812 R-CARBON;5.6KOHM,5%,1/8W,AA,TP,1.8X3.2MM  |        | .....6   | C 703    | 2203-005590 C-CERAMIC,CHIP;330NF,10%,16V,X7R,TP,2012 |        |
| .....5   | R673     | 2004-001970 R-METAL(S);1.8Kohm,1%,1/2W,AA,TP,6.5x2.5  |        | .....6   | C 704    | 2203-005590 C-CERAMIC,CHIP;330NF,10%,16V,X7R,TP,2012 |        |
| .....5   | R674     | 2001-001103 R-CARBON(S);20KOHM,5%,1/2W,AA,TP,2.4X6.4  |        | .....6   | C 705    | 2203-005005 C-CERAMIC,CHIP;100nF,10%,16V,X7R,TP,1608 |        |
| .....5   | R675     | 2004-001390 R-METAL(S);1Kohm,2%,1/2W,AA,TP,2.4x6.4mm  |        | .....6   | C 707    | 2203-000189 C-CERAMIC,CHIP;100nF,+80-20%,25V,Y5V,TP  |        |
| .....5   | R676     | 2004-001390 R-METAL(S);1Kohm,2%,1/2W,AA,TP,2.4x6.4mm  |        | .....6   | C 709    | 2203-000189 C-CERAMIC,CHIP;100nF,+80-20%,25V,Y5V,TP  |        |
| .....5   | R677     | 2001-001103 R-CARBON(S);20KOHM,5%,1/2W,AA,TP,2.4X6.4  |        | .....6   | C 710    | 2203-001652 C-CERAMIC,CHIP;470nF,+80-20%,16V,Y5V,TP  |        |
| .....5   | R678     | 2004-001970 R-METAL(S);1.8Kohm,1%,1/2W,AA,TP,6.5x2.5  |        | .....6   | C 711    | 2203-001652 C-CERAMIC,CHIP;470nF,+80-20%,16V,Y5V,TP  |        |
| .....5   | R679     | 2004-001970 R-METAL(S);1.8Kohm,1%,1/2W,AA,TP,6.5x2.5  |        | .....6   | C 712    | 2203-001652 C-CERAMIC,CHIP;470nF,+80-20%,16V,Y5V,TP  |        |
| .....5   | R680     | 2004-001970 R-METAL(S);1.8Kohm,1%,1/2W,AA,TP,6.5x2.5  |        | .....6   | C 713    | 2203-001652 C-CERAMIC,CHIP;470nF,+80-20%,16V,Y5V,TP  |        |
| .....5   | R681     | 2001-001146 R-CARBON(S);4.7OHM,5%,1/2W,AA,TP,2.4X6.4  |        | .....6   | C 714    | 2203-001652 C-CERAMIC,CHIP;470nF,+80-20%,16V,Y5V,TP  |        |
| .....5   | R682     | 2001-001146 R-CARBON(S);4.7OHM,5%,1/2W,AA,TP,2.4X6.4  |        | .....6   | C 715    | 2203-001652 C-CERAMIC,CHIP;470nF,+80-20%,16V,Y5V,TP  |        |
| .....5   | R683     | 2001-000290 R-CARBON;10KOHM,5%,1/8W,AA,TP,1.8X3.2MM   |        | .....6   | C 717    | 2203-000260 C-CERAMIC,CHIP;10nF,10%,50V,X7R,TP,2012  |        |
| .....5   | R685     | 2001-001000 R-CARBON;82KOHM,5%,1/8W,AA,TP,1.8X3.2MM   |        | .....6   | C 721    | 2203-000189 C-CERAMIC,CHIP;100nF,+80-20%,25V,Y5V,TP  |        |
| .....5   | R686     | 2001-000331 R-CARBON;12KOHM,5%,1/8W,AA,TP,1.8X3.2MM   |        | .....6   | C 722    | 2203-000189 C-CERAMIC,CHIP;100nF,+80-20%,25V,Y5V,TP  |        |
| .....5   | R687     | 2001-000812 R-CARBON;5.6KOHM,5%,1/8W,AA,TP,1.8X3.2MM  |        | .....6   | C 804    | 2203-000189 C-CERAMIC,CHIP;100nF,+80-20%,25V,Y5V,TP  |        |
| .....5   | R801     | 2001-001077 R-CARBON(S);150OHM,5%,1/2W,AA,TP,2.4X6.4  |        | .....6   | C 805    | 2203-000189 C-CERAMIC,CHIP;100nF,+80-20%,25V,Y5V,TP  |        |
| .....5   | R802     | 2001-000739 R-CARBON;4.7MOHM,5%,1/8W,AA,TP,1.8X3.2MM  |        | .....6   | C 807    | 2203-000189 C-CERAMIC,CHIP;100nF,+80-20%,25V,Y5V,TP  |        |
| .....5   | R803     | 2001-000739 R-CARBON;4.7MOHM,5%,1/8W,AA,TP,1.8X3.2MM  |        | .....6   | C 810    | 2203-000189 C-CERAMIC,CHIP;100nF,+80-20%,25V,Y5V,TP  |        |
| .....5   | R804     | 2001-000739 R-CARBON;4.7MOHM,5%,1/8W,AA,TP,1.8X3.2MM  |        | .....6   | C 811    | 2203-000189 C-CERAMIC,CHIP;100nF,+80-20%,25V,Y5V,TP  |        |
| .....5   | R805     | 2001-000037 R-CARBON(S);330OHM,5%,1/2W,AA,TP,2.4X6.4  |        | .....6   | C 814    | 2203-000189 C-CERAMIC,CHIP;100nF,+80-20%,25V,Y5V,TP  |        |
| .....5   | R806     | 2001-000739 R-CARBON;4.7MOHM,5%,1/8W,AA,TP,1.8X3.2MM  |        | .....6   | C 815    | 2203-000189 C-CERAMIC,CHIP;100nF,+80-20%,25V,Y5V,TP  |        |
| .....5   | R808     | 2001-000066 R-CARBON(S);10KOHM,5%,1/2W,AA,TP,2.4X6.4  |        | .....6   | C 818    | 2203-000189 C-CERAMIC,CHIP;100nF,+80-20%,25V,Y5V,TP  |        |
| .....5   | R809     | 2001-000739 R-CARBON;4.7MOHM,5%,1/8W,AA,TP,1.8X3.2MM  |        | .....6   | C 820    | 2203-000181 C-CERAMIC,CHIP;100nF,+80-20%,25V,Y5V,TP  |        |
| .....5   | R810     | 2001-000066 R-CARBON(S);10KOHM,5%,1/2W,AA,TP,2.4X6.4  |        | .....6   | C 821    | 2203-000181 C-CERAMIC,CHIP;100nF,+80-20%,25V,Y5V,TP  |        |
| .....5   | R811     | 2001-001182 R-CARBON(S);7.5KOHM,5%,1/2W,AA,TP,2.4X6.4 |        | .....6   | C 824    | 2203-000181 C-CERAMIC,CHIP;100nF,+80-20%,25V,Y5V,TP  |        |
| .....5   | R812     | 2001-000577 R-CARBON;2KOHM,5%,1/8W,AA,TP,1.8X3.2MM    |        | .....6   | C 825    | 2203-000181 C-CERAMIC,CHIP;100nF,+80-20%,25V,Y5V,TP  |        |
| .....5   | R813     | 2001-000508 R-CARBON;220KOHM,5%,1/8W,AA,TP,1.8X3.2MM  |        | .....6   | C 828    | 2203-000181 C-CERAMIC,CHIP;100nF,+80-20%,25V,Y5V,TP  |        |
| .....5   | R814     | 2003-001098 R-METAL OXIDE(S);22Kohm,5%,3W,AA,TP,6x16  |        | .....6   | C 829    | 2203-000181 C-CERAMIC,CHIP;100nF,+80-20%,25V,Y5V,TP  |        |
| .....5   | X601     | 2801-003903 CRYSTAL-UNIT;18.432MHz,25ppm,28-AAM,12pF  |        | .....6   | C 833    | 2203-000189 C-CERAMIC,CHIP;100nF,+80-20%,25V,Y5V,TP  |        |
| .....5   |          | AA97-07233J ASSY SMD,...                              | S.N.A  | .....6   | C 835    | 2203-000189 C-CERAMIC,CHIP;100nF,+80-20%,25V,Y5V,TP  |        |
| .....6   | C 101    | 2203-000260 C-CERAMIC,CHIP;10nF,10%,50V,X7R,TP,2012   |        | .....6   | C 902    | 2203-000189 C-CERAMIC,CHIP;100nF,+80-20%,25V,Y5V,TP  |        |
| .....6   | C 105    | 2203-000260 C-CERAMIC,CHIP;10nF,10%,50V,X7R,TP,2012   |        | .....6   | C 904    | 2203-000189 C-CERAMIC,CHIP;100nF,+80-20%,25V,Y5V,TP  |        |
| .....6   | C 107    | 2203-000260 C-CERAMIC,CHIP;10nF,10%,50V,X7R,TP,2012   |        | .....6   | D Z102   | 0403-000314 DIODE-ZENER;RLZJ9.1B.9.1V,8.80-9.30V,400 |        |
| .....6   | C 109    | 2203-000260 C-CERAMIC,CHIP;10nF,10%,50V,X7R,TP,2012   |        | .....6   | D Z104   | 0403-000314 DIODE-ZENER;RLZJ9.1B.9.1V,8.80-9.30V,400 |        |
| .....6   | C 110    | 2203-000260 C-CERAMIC,CHIP;10nF,10%,50V,X7R,TP,2012   |        | .....6   | D Z107   | 0403-000314 DIODE-ZENER;RLZJ9.1B.9.1V,8.80-9.30V,400 |        |
| .....6   | C 112    | 2203-000260 C-CERAMIC,CHIP;10nF,10%,50V,X7R,TP,2012   |        | .....6   | D Z108   | 0403-000314 DIODE-ZENER;RLZJ9.1B.9.1V,8.80-9.30V,400 |        |

| Loc. No.     | Code No.    | Description ; Specification               | Remark | Loc. No.    | Code No.    | Description ; Specification        | Remark |
|--------------|-------------|---|--------|-------------|-------------|------------------------------------|--------|
| .....6 DZ109 | 0403-000314 | DIODE-ZENER;RLZJ9.1B,9.1V,8.80-9.30V,400  |        | .....6 R164 | 2007-000094 | R-CHIP;22Kohm,5%,1/16W,DA,TP,1608  |        |
| .....6 DZ601 | 0403-001016 | DIODE-ZENER;RLZ6.2B,6.2V,5.96-6.27V,400m  |        | .....6 R165 | 2007-000094 | R-CHIP;22Kohm,5%,1/16W,DA,TP,1608  |        |
| .....6 DZ602 | 0403-001117 | DIODE-ZENER;RLZ12B,5%,500mW,LL-34,TP      |        | .....6 R166 | 2007-000077 | R-CHIP;470ohm,5%,1/16W,DA,TP,1608  |        |
| .....6 DZ603 | 0403-001016 | DIODE-ZENER;RLZ6.2B,6.2V,5.96-6.27V,400m  |        | .....6 R170 | 2007-000074 | R-CHIP;100ohm,5%,1/16W,DA,TP,1608  |        |
| .....6 DZ604 | 0403-001117 | DIODE-ZENER;RLZ12B,5%,500mW,LL-34,TP      |        | .....6 R171 | 2007-000074 | R-CHIP;100ohm,5%,1/16W,DA,TP,1608  |        |
| .....6 DZ701 | 0403-000314 | DIODE-ZENER;RLZJ9.1B,9.1V,8.80-9.30V,400  |        | .....6 R172 | 2007-000074 | R-CHIP;100ohm,5%,1/16W,DA,TP,1608  |        |
| .....6 DZ702 | 0403-001016 | DIODE-ZENER;RLZ6.2B,6.2V,5.96-6.27V,400m  |        | .....6 R173 | 2007-001167 | R-CHIP;75ohm,5%,1/16W,DA,TP,1608   |        |
| .....6 DZ703 | 0403-001016 | DIODE-ZENER;RLZ6.2B,6.2V,5.96-6.27V,400m  |        | .....6 R174 | 2007-001167 | R-CHIP;75ohm,5%,1/16W,DA,TP,1608   |        |
| .....6 DZ704 | 0403-000314 | DIODE-ZENER;RLZJ9.1B,9.1V,8.80-9.30V,400  |        | .....6 R601 | 2007-000074 | R-CHIP;100ohm,5%,1/16W,DA,TP,1608  |        |
| .....6 DZ705 | 0403-001117 | DIODE-ZENER;RLZ12B,5%,500mW,LL-34,TP      |        | .....6 R602 | 2007-000074 | R-CHIP;100ohm,5%,1/16W,DA,TP,1608  |        |
| .....6 DZ707 | 0403-001016 | DIODE-ZENER;RLZ6.2B,6.2V,5.96-6.27V,400m  |        | .....6 R603 | 2007-000078 | R-CHIP;1Kohm,5%,1/16W,DA,TP,1608   |        |
| .....6 IC602 | 1204-002002 | IC-SOUND PROCESSOR;MSP3420G-B11,POQFP,80P |        | .....6 R604 | 2007-000084 | R-CHIP;4.7Kohm,5%,1/16W,DA,TP,1608 |        |
| .....6 IC603 | 1201-000541 | IC-OP AMP;062,SOP8P,153MIL,DUAL,6V,mV,P   |        | .....6 R605 | 2007-001010 | R-CHIP;51Kohm,5%,1/16W,DA,TP,1608  |        |
| .....6 IC605 | 1001-001178 | IC-AUDIO SWITCH;TEA6422D,AUDIO SWITCH ,S  |        | .....6 R606 | 2007-001179 | R-CHIP;8.2Kohm,5%,1/16W,DA,TP,1608 |        |
| .....6 IC701 | 1001-001177 | IC-VIDEO SWITCH;TEA6425D,VIDEO SWITCH ,S  |        | .....6 R607 | 2007-000134 | R-CHIP;33Kohm,5%,1/16W,DA,TP,1608  |        |
| .....6 IC702 | 1001-001177 | IC-VIDEO SWITCH;TEA6425D,VIDEO SWITCH ,S  |        | .....6 R608 | 2007-000329 | R-CHIP;11Kohm,5%,1/16W,DA,TP,1608  |        |
| .....6 IC704 | 1002-001048 | IC-A/D&D/A CONVERTER;PCF8591T,8BIT,SOP,1  |        | .....6 R609 | 2007-000329 | R-CHIP;11Kohm,5%,1/16W,DA,TP,1608  |        |
| .....6 L125  | 2703-000398 | INDUCTOR-SMD;10uH,10%,3.2x2.5x2.2mm       |        | .....6 R610 | 2007-001010 | R-CHIP;51Kohm,5%,1/16W,DA,TP,1608  |        |
| .....6 L126  | 2703-000398 | INDUCTOR-SMD;10uH,10%,3.2x2.5x2.2mm       |        | .....6 R611 | 2007-000084 | R-CHIP;4.7Kohm,5%,1/16W,DA,TP,1608 |        |
| .....6 L601  | 2703-000398 | INDUCTOR-SMD;10uH,10%,3.2x2.5x2.2mm       |        | .....6 R612 | 2007-000134 | R-CHIP;33Kohm,5%,1/16W,DA,TP,1608  |        |
| .....6 L602  | 2703-000398 | INDUCTOR-SMD;10uH,10%,3.2x2.5x2.2mm       |        | .....6 R613 | 2007-001179 | R-CHIP;8.2Kohm,5%,1/16W,DA,TP,1608 |        |
| .....6 L603  | 2703-000398 | INDUCTOR-SMD;10uH,10%,3.2x2.5x2.2mm       |        | .....6 R624 | 2007-000074 | R-CHIP;100ohm,5%,1/16W,DA,TP,1608  |        |
| .....6 L604  | 2703-000398 | INDUCTOR-SMD;10uH,10%,3.2x2.5x2.2mm       |        | .....6 R625 | 2007-000074 | R-CHIP;100ohm,5%,1/16W,DA,TP,1608  |        |
| .....6 L701  | 2703-000398 | INDUCTOR-SMD;10uH,10%,3.2x2.5x2.2mm       |        | .....6 R626 | 2007-000074 | R-CHIP;100ohm,5%,1/16W,DA,TP,1608  |        |
| .....6 L702  | 3301-001324 | CORE-FERRITE BEAD;AB,150HM,2X1.25X0.9MM,  |        | .....6 R627 | 2007-000074 | R-CHIP;100ohm,5%,1/16W,DA,TP,1608  |        |
| .....6 L707  | 2703-000398 | INDUCTOR-SMD;10uH,10%,3.2x2.5x2.2mm       |        | .....6 R628 | 2007-000078 | R-CHIP;1Kohm,5%,1/16W,DA,TP,1608   |        |
| .....6 L708  | 2703-000398 | INDUCTOR-SMD;10uH,10%,3.2x2.5x2.2mm       |        | .....6 R629 | 2007-000078 | R-CHIP;1Kohm,5%,1/16W,DA,TP,1608   |        |
| .....6 L901  | 2703-000398 | INDUCTOR-SMD;10uH,10%,3.2x2.5x2.2mm       |        | .....6 R630 | 2007-000078 | R-CHIP;1Kohm,5%,1/16W,DA,TP,1608   |        |
| .....6 L902  | 2703-000398 | INDUCTOR-SMD;10uH,10%,3.2x2.5x2.2mm       |        | .....6 R631 | 2007-000078 | R-CHIP;1Kohm,5%,1/16W,DA,TP,1608   |        |
| .....6 PCB   | AA41-00597A | PCB-MAIN;FR-4,2L,A,1.6T,245X245,COMMAND   | S.N.A  | .....6 R632 | 2007-000078 | R-CHIP;1Kohm,5%,1/16W,DA,TP,1608   |        |
| .....6 Q101  | 0501-000344 | TR-SMALL SIGNAL;KSC1623-G,NPN,200mW,SOT-  |        | .....6 R633 | 2007-000078 | R-CHIP;1Kohm,5%,1/16W,DA,TP,1608   |        |
| .....6 Q103  | 0501-000344 | TR-SMALL SIGNAL;KSC1623-G,NPN,200mW,SOT-  |        | .....6 R634 | 2007-000078 | R-CHIP;1Kohm,5%,1/16W,DA,TP,1608   |        |
| .....6 Q106  | 0501-000344 | TR-SMALL SIGNAL;KSC1623-G,NPN,200mW,SOT-  |        | .....6 R635 | 2007-000078 | R-CHIP;1Kohm,5%,1/16W,DA,TP,1608   |        |
| .....6 Q703  | 0501-000344 | TR-SMALL SIGNAL;KSC1623-G,NPN,200mW,SOT-  |        | .....6 R636 | 2007-000078 | R-CHIP;1Kohm,5%,1/16W,DA,TP,1608   |        |
| .....6 Q704  | 0501-000344 | TR-SMALL SIGNAL;KSC1623-G,NPN,200mW,SOT-  |        | .....6 R637 | 2007-000078 | R-CHIP;1Kohm,5%,1/16W,DA,TP,1608   |        |
| .....6 Q707  | 0501-000344 | TR-SMALL SIGNAL;KSC1623-G,NPN,200mW,SOT-  |        | .....6 R641 | 2007-000078 | R-CHIP;1Kohm,5%,1/16W,DA,TP,1608   |        |
| .....6 Q708  | 0501-000344 | TR-SMALL SIGNAL;KSC1623-G,NPN,200mW,SOT-  |        | .....6 R642 | 2007-000078 | R-CHIP;1Kohm,5%,1/16W,DA,TP,1608   |        |
| .....6 Q709  | 0501-000344 | TR-SMALL SIGNAL;KSC1623-G,NPN,200mW,SOT-  |        | .....6 R643 | 2007-000078 | R-CHIP;1Kohm,5%,1/16W,DA,TP,1608   |        |
| .....6 Q710  | 0501-000344 | TR-SMALL SIGNAL;KSC1623-G,NPN,200mW,SOT-  |        | .....6 R646 | 2007-000074 | R-CHIP;100ohm,5%,1/16W,DA,TP,1608  |        |
| .....6 R101  | 2007-000070 | R-CHIP;0ohm,5%,1/16W,DA,TP,1608           |        | .....6 R647 | 2007-000074 | R-CHIP;100ohm,5%,1/16W,DA,TP,1608  |        |
| .....6 R102  | 2007-000074 | R-CHIP;100ohm,5%,1/16W,DA,TP,1608         |        | .....6 R651 | 2007-000078 | R-CHIP;1Kohm,5%,1/16W,DA,TP,1608   |        |
| .....6 R103  | 2007-000074 | R-CHIP;100ohm,5%,1/16W,DA,TP,1608         |        | .....6 R652 | 2007-000078 | R-CHIP;1Kohm,5%,1/16W,DA,TP,1608   |        |
| .....6 R104  | 2007-000828 | R-CHIP;39Kohm,1%,1/16W,DA,TP,1608         |        | .....6 R653 | 2007-000078 | R-CHIP;1Kohm,5%,1/16W,DA,TP,1608   |        |
| .....6 R105  | 2007-000098 | R-CHIP;56Kohm,5%,1/16W,DA,TP,1608         |        | .....6 R688 | 2007-000084 | R-CHIP;4.7Kohm,5%,1/16W,DA,TP,1608 |        |
| .....6 R106  | 2007-000078 | R-CHIP;1Kohm,5%,1/16W,DA,TP,1608          |        | .....6 R701 | 2007-001167 | R-CHIP;75ohm,5%,1/16W,DA,TP,1608   |        |
| .....6 R107  | 2007-000074 | R-CHIP;100ohm,5%,1/16W,DA,TP,1608         |        | .....6 R702 | 2007-001167 | R-CHIP;75ohm,5%,1/16W,DA,TP,1608   |        |
| .....6 R108  | 2007-000074 | R-CHIP;100ohm,5%,1/16W,DA,TP,1608         |        | .....6 R703 | 2007-000074 | R-CHIP;100ohm,5%,1/16W,DA,TP,1608  |        |
| .....6 R109  | 2007-000828 | R-CHIP;39Kohm,1%,1/16W,DA,TP,1608         |        | .....6 R704 | 2007-000097 | R-CHIP;47Kohm,5%,1/16W,DA,TP,1608  |        |
| .....6 R110  | 2007-000098 | R-CHIP;56Kohm,5%,1/16W,DA,TP,1608         |        | .....6 R706 | 2007-000070 | R-CHIP;0ohm,5%,1/16W,DA,TP,1608    |        |
| .....6 R113  | 2007-000074 | R-CHIP;100ohm,5%,1/16W,DA,TP,1608         |        | .....6 R707 | 2007-000074 | R-CHIP;100ohm,5%,1/16W,DA,TP,1608  |        |
| .....6 R114  | 2007-000074 | R-CHIP;100ohm,5%,1/16W,DA,TP,1608         |        | .....6 R708 | 2007-000070 | R-CHIP;0ohm,5%,1/16W,DA,TP,1608    |        |
| .....6 R115  | 2007-000074 | R-CHIP;100ohm,5%,1/16W,DA,TP,1608         |        | .....6 R709 | 2007-000074 | R-CHIP;100ohm,5%,1/16W,DA,TP,1608  |        |
| .....6 R116  | 2007-000074 | R-CHIP;100ohm,5%,1/16W,DA,TP,1608         |        | .....6 R710 | 2007-001167 | R-CHIP;75ohm,5%,1/16W,DA,TP,1608   |        |
| .....6 R117  | 2007-000070 | R-CHIP;0ohm,5%,1/16W,DA,TP,1608           |        | .....6 R712 | 2007-000070 | R-CHIP;0ohm,5%,1/16W,DA,TP,1608    |        |
| .....6 R118  | 2007-001167 | R-CHIP;75ohm,5%,1/16W,DA,TP,1608          |        | .....6 R713 | 2007-001167 | R-CHIP;75ohm,5%,1/16W,DA,TP,1608   |        |
| .....6 R119  | 2007-001167 | R-CHIP;75ohm,5%,1/16W,DA,TP,1608          |        | .....6 R714 | 2007-001167 | R-CHIP;75ohm,5%,1/16W,DA,TP,1608   |        |
| .....6 R120  | 2007-001167 | R-CHIP;75ohm,5%,1/16W,DA,TP,1608          |        | .....6 R716 | 2007-000097 | R-CHIP;47Kohm,5%,1/16W,DA,TP,1608  |        |
| .....6 R121  | 2007-001167 | R-CHIP;75ohm,5%,1/16W,DA,TP,1608          |        | .....6 R722 | 2007-000074 | R-CHIP;100ohm,5%,1/16W,DA,TP,1608  |        |
| .....6 R125  | 2007-000074 | R-CHIP;100ohm,5%,1/16W,DA,TP,1608         |        | .....6 R724 | 2007-000074 | R-CHIP;100ohm,5%,1/16W,DA,TP,1608  |        |
| .....6 R126  | 2007-000074 | R-CHIP;100ohm,5%,1/16W,DA,TP,1608         |        | .....6 R725 | 2007-001167 | R-CHIP;75ohm,5%,1/16W,DA,TP,1608   |        |
| .....6 R127  | 2007-000074 | R-CHIP;100ohm,5%,1/16W,DA,TP,1608         |        | .....6 R726 | 2007-001167 | R-CHIP;75ohm,5%,1/16W,DA,TP,1608   |        |
| .....6 R132  | 2007-001167 | R-CHIP;75ohm,5%,1/16W,DA,TP,1608          |        | .....6 R727 | 2007-001167 | R-CHIP;75ohm,5%,1/16W,DA,TP,1608   |        |
| .....6 R133  | 2007-001167 | R-CHIP;75ohm,5%,1/16W,DA,TP,1608          |        | .....6 R728 | 2007-000078 | R-CHIP;1Kohm,5%,1/16W,DA,TP,1608   |        |
| .....6 R134  | 2007-001167 | R-CHIP;75ohm,5%,1/16W,DA,TP,1608          |        | .....6 R729 | 2007-000070 | R-CHIP;0ohm,5%,1/16W,DA,TP,1608    |        |
| .....6 R137  | 2007-001167 | R-CHIP;75ohm,5%,1/16W,DA,TP,1608          |        | .....6 R730 | 2007-000076 | R-CHIP;330ohm,5%,1/16W,DA,TP,1608  |        |
| .....6 R138  | 2007-001167 | R-CHIP;75ohm,5%,1/16W,DA,TP,1608          |        | .....6 R731 | 2007-001167 | R-CHIP;75ohm,5%,1/16W,DA,TP,1608   |        |
| .....6 R140  | 2007-001167 | R-CHIP;75ohm,5%,1/16W,DA,TP,1608          |        | .....6 R738 | 2007-000127 | R-CHIP;9.1Kohm,5%,1/16W,DA,TP,1608 |        |
| .....6 R142  | 2007-001167 | R-CHIP;75ohm,5%,1/16W,DA,TP,1608          |        | .....6 R739 | 2007-000093 | R-CHIP;20Kohm,5%,1/16W,DA,TP,1608  |        |
| .....6 R143  | 2007-000070 | R-CHIP;0ohm,5%,1/16W,DA,TP,1608           |        | .....6 R740 | 2007-000127 | R-CHIP;9.1Kohm,5%,1/16W,DA,TP,1608 |        |
| .....6 R145  | 2007-000070 | R-CHIP;0ohm,5%,1/16W,DA,TP,1608           |        | .....6 R741 | 2007-000093 | R-CHIP;20Kohm,5%,1/16W,DA,TP,1608  |        |
| .....6 R148  | 2007-000070 | R-CHIP;0ohm,5%,1/16W,DA,TP,1608           |        | .....6 R742 | 2007-000127 | R-CHIP;9.1Kohm,5%,1/16W,DA,TP,1608 |        |
| .....6 R149  | 2007-000094 | R-CHIP;22Kohm,5%,1/16W,DA,TP,1608         |        | .....6 R743 | 2007-000093 | R-CHIP;20Kohm,5%,1/16W,DA,TP,1608  |        |
| .....6 R150  | 2007-000077 | R-CHIP;470ohm,5%,1/16W,DA,TP,1608         |        | .....6 R744 | 2007-000093 | R-CHIP;20Kohm,5%,1/16W,DA,TP,1608  |        |
| .....6 R151  | 2007-000094 | R-CHIP;22Kohm,5%,1/16W,DA,TP,1608         |        | .....6 R745 | 2007-000127 | R-CHIP;9.1Kohm,5%,1/16W,DA,TP,1608 |        |
| .....6 R155  | 2007-000094 | R-CHIP;22Kohm,5%,1/16W,DA,TP,1608         |        | .....6 R746 | 2007-000090 | R-CHIP;10KOHM,5%,1/16W,DA,TP,1608  |        |
| .....6 R156  | 2007-000094 | R-CHIP;22Kohm,5%,1/16W,DA,TP,1608         |        | .....6 R747 | 2007-000090 | R-CHIP;10KOHM,5%,1/16W,DA,TP,1608  |        |
| .....6 R157  | 2007-000077 | R-CHIP;470ohm,5%,1/16W,DA,TP,1608         |        | .....6 R748 | 2007-000090 | R-CHIP;10KOHM,5%,1/16W,DA,TP,1608  |        |

Electrical Parts List

| Loc. No. | Code No.    | Description ; Specification       | Remark                                   | Loc. No. | Code No. | Description ; Specification | Remark                                   |  |
|----------|-------------|-----------------------------------|--|----------|----------|-----------------------------|--|--|
| .....6   | R749        | 2007-000090                       | R-CHIP;10KOHM,5%,1/16W,DA,TP,1608        | .....5   | C50      | 2203-000357                 | C-CERAMIC,CHIP;0.15nF,5%,50V,NPO,TP,1608 |  |
| .....6   | R750        | 2007-000084                       | R-CHIP;4.7Kohm,5%,1/16W,DA,TP,1608       | .....5   | C51      | 2203-001071                 | C-CERAMIC,CHIP;0.056nF,5%,50V,NPO,TP,160 |  |
| .....6   | R751        | 2007-001010                       | R-CHIP;51Kohm,5%,1/16W,DA,TP,1608        | .....5   | C52      | 2203-000041                 | C-CERAMIC,CHIP;0.01nF,0.25pF,50V,NPO,TP, |  |
| .....6   | R752        | 2007-001010                       | R-CHIP;51Kohm,5%,1/16W,DA,TP,1608        | .....5   | C53      | 2203-000181                 | C-CERAMIC,CHIP;100nF,+80-20%,25V,Y5V,TP, |  |
| .....6   | R753        | 2007-001010                       | R-CHIP;51Kohm,5%,1/16W,DA,TP,1608        | .....5   | C54      | 2203-000181                 | C-CERAMIC,CHIP;100nF,+80-20%,25V,Y5V,TP, |  |
| .....6   | R754        | 2007-001010                       | R-CHIP;51Kohm,5%,1/16W,DA,TP,1608        | .....5   | C55      | 2203-000357                 | C-CERAMIC,CHIP;0.15nF,5%,50V,NPO,TP,1608 |  |
| .....6   | R755        | 2007-000084                       | R-CHIP;4.7Kohm,5%,1/16W,DA,TP,1608       | .....5   | C56      | 2203-001071                 | C-CERAMIC,CHIP;0.056nF,5%,50V,NPO,TP,160 |  |
| .....6   | R756        | 2007-000074                       | R-CHIP;100ohm,5%,1/16W,DA,TP,1608        | .....5   | C57      | 2203-000041                 | C-CERAMIC,CHIP;0.01nF,0.25pF,50V,NPO,TP, |  |
| .....6   | R757        | 2007-000074                       | R-CHIP;100ohm,5%,1/16W,DA,TP,1608        | .....5   | C58      | 2203-000181                 | C-CERAMIC,CHIP;100nF,+80-20%,25V,Y5V,TP, |  |
| .....6   | R775        | 2007-000070                       | R-CHIP;0ohm,5%,1/16W,DA,TP,1608          | .....5   | C59      | 2203-000357                 | C-CERAMIC,CHIP;0.15nF,5%,50V,NPO,TP,1608 |  |
| .....6   | R776        | 2007-000070                       | R-CHIP;0ohm,5%,1/16W,DA,TP,1608          | .....5   | C60      | 2203-001071                 | C-CERAMIC,CHIP;0.056nF,5%,50V,NPO,TP,160 |  |
| .....6   | R777        | 2007-000070                       | R-CHIP;0ohm,5%,1/16W,DA,TP,1608          | .....5   | C61      | 2203-000041                 | C-CERAMIC,CHIP;0.01nF,0.25pF,50V,NPO,TP, |  |
| .....6   | R780        | 2007-000084                       | R-CHIP;4.7Kohm,5%,1/16W,DA,TP,1608       | .....5   | C62      | 2203-000181                 | C-CERAMIC,CHIP;100nF,+80-20%,25V,Y5V,TP, |  |
| .....6   | R788        | 2007-000070                       | R-CHIP;0ohm,5%,1/16W,DA,TP,1608          | .....5   | C63      | 2203-000357                 | C-CERAMIC,CHIP;0.15nF,5%,50V,NPO,TP,1608 |  |
| .....6   | R789        | 2007-000070                       | R-CHIP;0ohm,5%,1/16W,DA,TP,1608          | .....5   | C64      | 2203-001071                 | C-CERAMIC,CHIP;0.056nF,5%,50V,NPO,TP,160 |  |
| .....6   | R791        | 2007-000070                       | R-CHIP;0ohm,5%,1/16W,DA,TP,1608          | .....5   | C65      | 2203-000041                 | C-CERAMIC,CHIP;0.01nF,0.25pF,50V,NPO,TP, |  |
| .....6   | R792        | 2007-001167                       | R-CHIP;75ohm,5%,1/16W,DA,TP,1608         | .....5   | C66      | 2203-001083                 | C-CERAMIC,CHIP;0.005nF,0.1pF,50V,NPO,TP, |  |
| .....6   | R793        | 2007-000078                       | R-CHIP;1Kohm,5%,1/16W,DA,TP,1608         | .....5   | C67      | 2203-001083                 | C-CERAMIC,CHIP;0.005nF,0.1pF,50V,NPO,TP, |  |
| .....6   | R794        | 2007-000070                       | R-CHIP;0ohm,5%,1/16W,DA,TP,1608          | .....5   | C68      | 2203-001083                 | C-CERAMIC,CHIP;0.005nF,0.1pF,50V,NPO,TP, |  |
| .....6   | R795        | 2007-000070                       | R-CHIP;0ohm,5%,1/16W,DA,TP,1608          | .....5   | C69      | 2203-001083                 | C-CERAMIC,CHIP;0.005nF,0.1pF,50V,NPO,TP, |  |
| .....6   | R797        | 2007-000468                       | R-CHIP;1KOHM,5%,1/10W,DA,TP,2012         | .....5   | C70      | 2402-001042                 | C-AL,SMD;100uF,20%,16V,GP,TP,6.6x6.6x5.4 |  |
| .....6   | R798        | 2007-000468                       | R-CHIP;1KOHM,5%,1/10W,DA,TP,2012         | .....5   | C71      | 2203-000181                 | C-CERAMIC,CHIP;100nF,+80-20%,25V,Y5V,TP, |  |
| .....6   | R799        | 2007-001167                       | R-CHIP;75ohm,5%,1/16W,DA,TP,1608         | .....5   | C72      | 2203-000257                 | C-CERAMIC,CHIP;10nF,10%,50V,X7R,TP,1608  |  |
| .....6   | R79B        | 2007-000070                       | R-CHIP;0ohm,5%,1/16W,DA,TP,1608          | .....5   | C73      | 2203-000975                 | C-CERAMIC,CHIP;47nF,10%,25V,X7R,TP,1608, |  |
| .....6   | R904        | 2007-000070                       | R-CHIP;0ohm,5%,1/16W,DA,TP,1608          | .....5   | C74      | 2203-000975                 | C-CERAMIC,CHIP;47nF,10%,25V,X7R,TP,1608, |  |
| .....6   | R97C        | 2007-000070                       | R-CHIP;0ohm,5%,1/16W,DA,TP,1608          | .....5   | C75      | 2203-000257                 | C-CERAMIC,CHIP;10nF,10%,50V,X7R,TP,1608  |  |
| ....3    | AA95-02039A | ASSY SUB-PCB,CONV MDL;COMMANDO, , |  | .....5   | C77      | 2203-000440                 | C-CERAMIC,CHIP;1nF,10%,50V,X7R,TP,1608,- |  |
| ....4    | CN01        | 3703-001124                       | CONNECTOR-DIN;32P,2R,MALE,ANGLE,AUF      | .....5   | C78      | 2203-000181                 | C-CERAMIC,CHIP;100nF,+80-20%,25V,Y5V,TP, |  |
| ....4    | CN04        | 3711-003601                       | CONNECTOR-HEADER;BOX,12P,1R,2.5mm,ANGLE, | .....5   | C79      | 2203-000181                 | C-CERAMIC,CHIP;100nF,+80-20%,25V,Y5V,TP, |  |
| ....4    |             | 0202-000187                       | SOLDER-WIRE FLUX;-RS60S,D1 2.63Sn/37Pb   | S.N.A    | .....5   | C80                         | 2402-001049                              | C-AL,CHIP;10uF,20%,16V,GP,TP,3.3x3.3x5.4 |
| ....4    |             | 0202-001167                       | SOLDER-CREAM;RX3603-2330HO,S45A,PASTE,SN | S.N.A    | .....5   | C81                         | 2203-000041                              | C-CERAMIC,CHIP;0.01nF,0.25pF,50V,NPO,TP, |
| ....4    |             | AA97-07269A                       | ASSY SMD;1 , , , ,                       | S.N.A    | .....5   | C82                         | 2203-001071                              | C-CERAMIC,CHIP;0.056nF,5%,50V,NPO,TP,160 |
| .....5   | C01         | 2402-001042                       | C-AL,SMD;100uF,20%,16V,GP,TP,6.6x6.6x5.4 | .....5   | C83      | 2203-000181                 | C-CERAMIC,CHIP;100nF,+80-20%,25V,Y5V,TP, |  |
| .....5   | C02         | 2203-000181                       | C-CERAMIC,CHIP;100nF,+80-20%,25V,Y5V,TP, | .....5   | C84      | 2402-001042                 | C-AL,SMD;100uF,20%,16V,GP,TP,6.6x6.6x5.4 |  |
| .....5   | C03         | 2402-001042                       | C-AL,SMD;100uF,20%,16V,GP,TP,6.6x6.6x5.4 | .....5   | C85      | 2203-000181                 | C-CERAMIC,CHIP;100nF,+80-20%,25V,Y5V,TP, |  |
| .....5   | C04         | 2203-000181                       | C-CERAMIC,CHIP;100nF,+80-20%,25V,Y5V,TP, | .....5   | C86      | 2203-000181                 | C-CERAMIC,CHIP;100nF,+80-20%,25V,Y5V,TP, |  |
| .....5   | C05         | 2203-000181                       | C-CERAMIC,CHIP;100nF,+80-20%,25V,Y5V,TP, | .....5   | C87      | 2203-001245                 | C-CERAMIC,CHIP;0.082nF,5%,50V,NPO,TP,201 |  |
| .....5   | C06         | 2402-001042                       | C-AL,SMD;100uF,20%,16V,GP,TP,6.6x6.6x5.4 | .....5   | C88      | 2203-000975                 | C-CERAMIC,CHIP;47nF,10%,25V,X7R,TP,1608, |  |
| .....5   | C07         | 2203-000181                       | C-CERAMIC,CHIP;100nF,+80-20%,25V,Y5V,TP, | .....5   | C89      | 2203-000257                 | C-CERAMIC,CHIP;10nF,10%,50V,X7R,TP,1608  |  |
| .....5   | C08         | 2203-000181                       | C-CERAMIC,CHIP;100nF,+80-20%,25V,Y5V,TP, | .....5   | C90      | 2203-000575                 | C-CERAMIC,CHIP;220NF,10%,25V,X7R,TP,2012 |  |
| .....5   | C09         | 2203-000181                       | C-CERAMIC,CHIP;100nF,+80-20%,25V,Y5V,TP, | .....5   | C91      | 2203-000575                 | C-CERAMIC,CHIP;220NF,10%,25V,X7R,TP,2012 |  |
| .....5   | C10         | 2203-000181                       | C-CERAMIC,CHIP;100nF,+80-20%,25V,Y5V,TP, | .....5   | D01      | 0401-000160                 | DIODE-SWITCHING;ISS314,30V,100mA,USC,TP  |  |
| .....5   | C11         | 2203-000181                       | C-CERAMIC,CHIP;100nF,+80-20%,25V,Y5V,TP, | .....5   | D02      | 0401-000160                 | DIODE-SWITCHING;ISS314,30V,100mA,USC,TP  |  |
| .....5   | C12         | 2203-000181                       | C-CERAMIC,CHIP;100nF,+80-20%,25V,Y5V,TP, | .....5   | D03      | 0401-000160                 | DIODE-SWITCHING;ISS314,30V,100mA,USC,TP  |  |
| .....5   | C13         | 2203-000181                       | C-CERAMIC,CHIP;100nF,+80-20%,25V,Y5V,TP, | .....5   | D04      | 0401-000160                 | DIODE-SWITCHING;ISS314,30V,100mA,USC,TP  |  |
| .....5   | C14         | 2402-001042                       | C-AL,SMD;100uF,20%,16V,GP,TP,6.6x6.6x5.4 | .....5   | D05      | 0401-000160                 | DIODE-SWITCHING;ISS314,30V,100mA,USC,TP  |  |
| .....5   | C15         | 2203-000181                       | C-CERAMIC,CHIP;100nF,+80-20%,25V,Y5V,TP, | .....5   | D06      | 0401-000160                 | DIODE-SWITCHING;ISS314,30V,100mA,USC,TP  |  |
| .....5   | C20         | 2203-000181                       | C-CERAMIC,CHIP;100nF,+80-20%,25V,Y5V,TP, | .....5   | DZ01     | 0403-001016                 | DIODE-ZENER;RL26.2B,6.2V,5.96-6.27V,400m |  |
| .....5   | C21         | 2203-000181                       | C-CERAMIC,CHIP;100nF,+80-20%,25V,Y5V,TP, | .....5   | DZ02     | 0403-001016                 | DIODE-ZENER;RL26.2B,6.2V,5.96-6.27V,400m |  |
| .....5   | C22         | 2203-000181                       | C-CERAMIC,CHIP;100nF,+80-20%,25V,Y5V,TP, | .....5   | DZ03     | 0403-001016                 | DIODE-ZENER;RL26.2B,6.2V,5.96-6.27V,400m |  |
| .....5   | C23         | 2203-000181                       | C-CERAMIC,CHIP;100nF,+80-20%,25V,Y5V,TP, | .....5   | EF01     | 2901-000229                 | FILTER-EMI SMD;50V,0.3A,-,22000pF,4.5x3. |  |
| .....5   | C24         | 2203-000181                       | C-CERAMIC,CHIP;100nF,+80-20%,25V,Y5V,TP, | .....5   | EF02     | 2901-000229                 | FILTER-EMI SMD;50V,0.3A,-,22000pF,4.5x3. |  |
| .....5   | C25         | 2203-000181                       | C-CERAMIC,CHIP;100nF,+80-20%,25V,Y5V,TP, | .....5   | EF03     | 3301-001324                 | CORE-FERRITE BEAD;AB,150HM,2X1.25X0.9MM, |  |
| .....5   | C26         | 2203-000181                       | C-CERAMIC,CHIP;100nF,+80-20%,25V,Y5V,TP, | .....5   | EF04     | 3301-001324                 | CORE-FERRITE BEAD;AB,150HM,2X1.25X0.9MM, |  |
| .....5   | C27         | 2203-000181                       | C-CERAMIC,CHIP;100nF,+80-20%,25V,Y5V,TP, | .....5   | EF05     | 2901-000226                 | FILTER-EMI SMD;25V,0.3A,-,100pF,3.2x1.25 |  |
| .....5   | C28         | 2203-000181                       | C-CERAMIC,CHIP;100nF,+80-20%,25V,Y5V,TP, | .....5   | EF06     | 2901-000226                 | FILTER-EMI SMD;25V,0.3A,-,100pF,3.2x1.25 |  |
| .....5   | C29         | 2203-000181                       | C-CERAMIC,CHIP;100nF,+80-20%,25V,Y5V,TP, | .....5   | EF07     | 3301-001324                 | CORE-FERRITE BEAD;AB,150HM,2X1.25X0.9MM, |  |
| .....5   | C30         | 2203-000181                       | C-CERAMIC,CHIP;100nF,+80-20%,25V,Y5V,TP, | .....5   | EF08     | 3301-001324                 | CORE-FERRITE BEAD;AB,150HM,2X1.25X0.9MM, |  |
| .....5   | C31         | 2203-000181                       | C-CERAMIC,CHIP;100nF,+80-20%,25V,Y5V,TP, | .....5   | EF09     | 3301-001324                 | CORE-FERRITE BEAD;AB,150HM,2X1.25X0.9MM, |  |
| .....5   | C32         | 2203-000181                       | C-CERAMIC,CHIP;100nF,+80-20%,25V,Y5V,TP, | .....5   | EF10     | 3301-001324                 | CORE-FERRITE BEAD;AB,150HM,2X1.25X0.9MM, |  |
| .....5   | C33         | 2203-000181                       | C-CERAMIC,CHIP;100nF,+80-20%,25V,Y5V,TP, | .....5   | IC01     | BP13-00003A                 | IC ASIC;SDC12,128-0.3 TO +3.8,0 TO 70.Q  |  |
| .....5   | C34         | 2203-000181                       | C-CERAMIC,CHIP;100nF,+80-20%,25V,Y5V,TP, | .....5   | IC02     | 1203-002302                 | IC-POSI.FIXED REG.;78RM33D,D-PAK,3P,-,PL |  |
| .....5   | C35         | 2203-000181                       | C-CERAMIC,CHIP;100nF,+80-20%,25V,Y5V,TP, | .....5   | IC03     | 1203-001824                 | IC-VOL. DETECTOR;7042,SOT-89,3P,-,PLASTI |  |
| .....5   | C36         | 2203-000181                       | C-CERAMIC,CHIP;100nF,+80-20%,25V,Y5V,TP, | .....5   | IC04     | 0801-002345                 | IC-CMOS LOGIC;7S04,INVERTER,SOT-353,5P,4 |  |
| .....5   | C37         | 2203-000181                       | C-CERAMIC,CHIP;100nF,+80-20%,25V,Y5V,TP, | .....5   | IC05     | 1103-001195                 | IC-EEPROM;24C64,8Kx8Bit,SOP,8P,150MIL,10 |  |
| .....5   | C38         | 2402-001042                       | C-AL,SMD;100uF,20%,16V,GP,TP,6.6x6.6x5.4 | .....5   | IC06     | AA09-00032A                 | IC-MCU;TSC8725162D-OTP,4.5 TO 5.5V,-,32  |  |
| .....5   | C39         | 2203-000181                       | C-CERAMIC,CHIP;100nF,+80-20%,25V,Y5V,TP, | .....5   | IC07     | 1201-001520                 | IC-VIDEO AMP;EL2250CS,SOIC,8P,150MIL,DUA |  |
| .....5   | C40         | 2402-001042                       | C-AL,SMD;100uF,20%,16V,GP,TP,6.6x6.6x5.4 | .....5   | IC08     | 1001-000164                 | IC-ANALOG MULTIPLEX;74HC4052,CMOS,SOP,16 |  |
| .....5   | C41         | 2203-000181                       | C-CERAMIC,CHIP;100nF,+80-20%,25V,Y5V,TP, | .....5   | IC09     | 1201-001504                 | IC-OP AMP;072,SOP,8P,150MIL,DUAL,-,PLAST |  |
| .....5   | C42         | 2203-000357                       | C-CERAMIC,CHIP;0.15nF,5%,50V,NPO,TP,1608 | .....5   | IC10     | 1201-001504                 | IC-OP AMP;072,SOP,8P,150MIL,DUAL,-,PLAST |  |
| .....5   | C43         | 2203-001071                       | C-CERAMIC,CHIP;0.056nF,5%,50V,NPO,TP,160 | .....5   | IC11     | 1201-001504                 | IC-OP AMP;072,SOP,8P,150MIL,DUAL,-,PLAST |  |
| .....5   | C44         | 2203-000041                       | C-CERAMIC,CHIP;0.01nF,0.25pF,50V,NPO,TP, | .....5   | IC12     | 1201-001135                 | IC-OP AMP;324,SOP,ST,14P,150MIL,QUAD,100 |  |
| .....5   | C45         | 2203-000181                       | C-CERAMIC,CHIP;100nF,+80-20%,25V,Y5V,TP, | .....5   | IC13     | 1001-001155                 | IC-ANALOG MULTIPLEX;NC75B3157P6X,CMOS,SC |  |
| .....5   | C46         | 2203-000357                       | C-CERAMIC,CHIP;0.15nF,5%,50V,NPO,TP,1608 | .....5   | IC14     | 1201-001504                 | IC-OP AMP;072,SOP,8P,150MIL,DUAL,-,PLAST |  |
| .....5   | C47         | 2203-001071                       | C-CERAMIC,CHIP;0.056nF,5%,50V,NPO,TP,160 | .....5   | IC15     | 0801-002345                 | IC-CMOS LOGIC;7S04,INVERTER,SOT-353,5P,4 |  |
| .....5   | C48         | 2203-000041                       | C-CERAMIC,CHIP;0.01nF,0.25pF,50V,NPO,TP, | .....5   | IC16     | 0801-002345                 | IC-CMOS LOGIC;7S04,INVERTER,SOT-353,5P,4 |  |
| .....5   | C49         | 2203-000181                       | C-CERAMIC,CHIP;100nF,+80-20%,25V,Y5V,TP, | .....5   | IC17     | 1209-001163                 | IC-PLL;TLC2932IPWLE,SOP,14P,-,PLASTIC    |  |

| Loc. No. | Code No. | Description ; Specification | Remark  | Loc. No. | Code No.    | Description ; Specification         | Remark                                    |
|----------|----------|-----------------------------|---|----------|-------------|-------------------------------------|---|
| .....5   | L01      | 2701-001030                 | INDUCTOR-AXIAL;43uH,10%,5x14mm                | .....5   | R47         | 2007-000074                         | R-CHIP;100ohm,5%,1/16W,DA,TP,1608         |
| .....5   | OSC01    | 2804-001479                 | OSCILLATOR-CLOCK;24MHZ,100PPM,50PF,TP,5V      | .....5   | R48         | 2007-000084                         | R-CHIP;4.7Kohm,5%,1/16W,DA,TP,1608        |
| .....5   | PCB      | AA41-00717A                 | PCB-CONVERGENCE MODULE;HCM4215W,FR-4,4L,S.N.A | .....5   | R49         | 2007-000084                         | R-CHIP;4.7Kohm,5%,1/16W,DA,TP,1608        |
| .....5   | Q02      | 0501-000280                 | TR-SMALL SIGNAL;KSA1182,PNP,150mW,SOT-23      | .....5   | R50         | 2007-000078                         | R-CHIP;1Kohm,5%,1/16W,DA,TP,1608          |
| .....5   | Q03      | 0501-000280                 | TR-SMALL SIGNAL;KSA1182,PNP,150mW,SOT-23      | .....5   | R51         | 2007-000080                         | R-CHIP;2Kohm,5%,1/16W,DA,TP,1608          |
| .....5   | Q04      | 0501-000342                 | TR-SMALL SIGNAL;KSC1623-Y,NPN,200mW,SOT-      | .....5   | R52         | 2007-000078                         | R-CHIP;1Kohm,5%,1/16W,DA,TP,1608          |
| .....5   | Q07      | 0505-000110                 | FET-SILICON;2N7002,N,60V,115MA,7.5OHM,0.      | .....5   | R53         | 2007-000074                         | R-CHIP;100ohm,5%,1/16W,DA,TP,1608         |
| .....5   | Q08      | 0505-000110                 | FET-SILICON;2N7002,N,60V,115MA,7.5OHM,0.      | .....5   | R54         | 2007-000084                         | R-CHIP;4.7Kohm,5%,1/16W,DA,TP,1608        |
| .....5   | Q09      | 0505-000110                 | FET-SILICON;2N7002,N,60V,115MA,7.5OHM,0.      | .....5   | R55         | 2007-000084                         | R-CHIP;4.7Kohm,5%,1/16W,DA,TP,1608        |
| .....5   | Q10      | 0501-000342                 | TR-SMALL SIGNAL;KSC1623-Y,NPN,200mW,SOT-      | .....5   | R56         | 2007-000078                         | R-CHIP;1Kohm,5%,1/16W,DA,TP,1608          |
| .....5   | R01      | 2007-000084                 | R-CHIP;4.7Kohm,5%,1/16W,DA,TP,1608            | .....5   | R57         | 2007-000080                         | R-CHIP;2Kohm,5%,1/16W,DA,TP,1608          |
| .....5   | R02      | 2007-000074                 | R-CHIP;100ohm,5%,1/16W,DA,TP,1608             | .....5   | R58         | 2007-000078                         | R-CHIP;1Kohm,5%,1/16W,DA,TP,1608          |
| .....5   | R03      | 2007-000078                 | R-CHIP;1Kohm,5%,1/16W,DA,TP,1608              | .....5   | R59         | 2007-000074                         | R-CHIP;100ohm,5%,1/16W,DA,TP,1608         |
| .....5   | R04      | 2007-000084                 | R-CHIP;4.7Kohm,5%,1/16W,DA,TP,1608            | .....5   | R60         | 2007-000084                         | R-CHIP;4.7Kohm,5%,1/16W,DA,TP,1608        |
| .....5   | R05      | 2007-000102                 | R-CHIP;100Kohm,5%,1/16W,DA,TP,1608            | .....5   | R61         | 2007-000084                         | R-CHIP;4.7Kohm,5%,1/16W,DA,TP,1608        |
| .....5   | R06      | 2007-000084                 | R-CHIP;4.7Kohm,5%,1/16W,DA,TP,1608            | .....5   | R62         | 2007-000078                         | R-CHIP;1Kohm,5%,1/16W,DA,TP,1608          |
| .....5   | R07      | 2007-000084                 | R-CHIP;4.7Kohm,5%,1/16W,DA,TP,1608            | .....5   | R63         | 2007-000080                         | R-CHIP;2Kohm,5%,1/16W,DA,TP,1608          |
| .....5   | R08      | 2007-000084                 | R-CHIP;4.7Kohm,5%,1/16W,DA,TP,1608            | .....5   | R64         | 2007-000078                         | R-CHIP;1Kohm,5%,1/16W,DA,TP,1608          |
| .....5   | R09      | 2007-000072                 | R-CHIP;47ohm,5%,1/16W,DA,TP,1608              | .....5   | R65         | 2007-000074                         | R-CHIP;100ohm,5%,1/16W,DA,TP,1608         |
| .....5   | R10      | 2007-000072                 | R-CHIP;47ohm,5%,1/16W,DA,TP,1608              | .....5   | R66         | 2007-000084                         | R-CHIP;4.7Kohm,5%,1/16W,DA,TP,1608        |
| .....5   | R100     | 2007-000125                 | R-CHIP;3.9Kohm,5%,1/16W,DA,TP,1608            | .....5   | R67         | 2007-000084                         | R-CHIP;4.7Kohm,5%,1/16W,DA,TP,1608        |
| .....5   | R101     | 2007-000090                 | R-CHIP;10KOHM,5%,1/16W,DA,TP,1608             | .....5   | R68         | 2007-000078                         | R-CHIP;1Kohm,5%,1/16W,DA,TP,1608          |
| .....5   | R107     | 2007-000122                 | R-CHIP;1.2Kohm,5%,1/16W,DA,TP,1608            | .....5   | R69         | 2007-000080                         | R-CHIP;2Kohm,5%,1/16W,DA,TP,1608          |
| .....5   | R108     | 2007-000381                 | R-CHIP;13Kohm,5%,1/16W,DA,TP,1608             | .....5   | R70         | 2007-000078                         | R-CHIP;1Kohm,5%,1/16W,DA,TP,1608          |
| .....5   | R109     | 2007-000082                 | R-CHIP;3.3Kohm,5%,1/16W,DA,TP,1608            | .....5   | R71         | 2007-000074                         | R-CHIP;100ohm,5%,1/16W,DA,TP,1608         |
| .....5   | R11      | 2007-000078                 | R-CHIP;1Kohm,5%,1/16W,DA,TP,1608              | .....5   | R72         | 2007-000084                         | R-CHIP;4.7Kohm,5%,1/16W,DA,TP,1608        |
| .....5   | R110     | 2007-000078                 | R-CHIP;1Kohm,5%,1/16W,DA,TP,1608              | .....5   | R73         | 2007-000084                         | R-CHIP;4.7Kohm,5%,1/16W,DA,TP,1608        |
| .....5   | R113     | 2007-000090                 | R-CHIP;10KOHM,5%,1/16W,DA,TP,1608             | .....5   | R74         | 2007-000078                         | R-CHIP;1Kohm,5%,1/16W,DA,TP,1608          |
| .....5   | R114     | 2007-000090                 | R-CHIP;10KOHM,5%,1/16W,DA,TP,1608             | .....5   | R75         | 2007-000080                         | R-CHIP;2Kohm,5%,1/16W,DA,TP,1608          |
| .....5   | R115     | 2007-000090                 | R-CHIP;10KOHM,5%,1/16W,DA,TP,1608             | .....5   | R76         | 2007-000078                         | R-CHIP;1Kohm,5%,1/16W,DA,TP,1608          |
| .....5   | R116     | 2007-001179                 | R-CHIP;8.2Kohm,5%,1/16W,DA,TP,1608            | .....5   | R77         | 2007-000074                         | R-CHIP;100ohm,5%,1/16W,DA,TP,1608         |
| .....5   | R117     | 2007-000122                 | R-CHIP;1.2Kohm,5%,1/16W,DA,TP,1608            | .....5   | R78         | 2007-000084                         | R-CHIP;4.7Kohm,5%,1/16W,DA,TP,1608        |
| .....5   | R118     | 2007-000084                 | R-CHIP;4.7Kohm,5%,1/16W,DA,TP,1608            | .....5   | R79         | 2007-000084                         | R-CHIP;4.7Kohm,5%,1/16W,DA,TP,1608        |
| .....5   | R119     | 2007-000084                 | R-CHIP;4.7Kohm,5%,1/16W,DA,TP,1608            | .....5   | R80         | 2007-000078                         | R-CHIP;1Kohm,5%,1/16W,DA,TP,1608          |
| .....5   | R120     | 2007-000124                 | R-CHIP;2.2Kohm,5%,1/16W,DA,TP,1608            | .....5   | R81         | 2007-000080                         | R-CHIP;2Kohm,5%,1/16W,DA,TP,1608          |
| .....5   | R121     | 2007-000084                 | R-CHIP;4.7Kohm,5%,1/16W,DA,TP,1608            | .....5   | R82         | 2007-000078                         | R-CHIP;1Kohm,5%,1/16W,DA,TP,1608          |
| .....5   | R122     | 2007-000070                 | R-CHIP;0ohm,5%,1/16W,DA,TP,1608               | .....5   | R87         | 2007-000757                         | R-CHIP;330KOHM,5%,1/10W,DA,TP,2012        |
| .....5   | R123     | 2007-000070                 | R-CHIP;0ohm,5%,1/16W,DA,TP,1608               | .....5   | R88         | 2007-000757                         | R-CHIP;330KOHM,5%,1/10W,DA,TP,2012        |
| .....5   | R125     | 2007-000355                 | R-CHIP;12KOHM,5%,1/10W,DA,TP,2012             | .....5   | R89         | 2007-000757                         | R-CHIP;330KOHM,5%,1/10W,DA,TP,2012        |
| .....5   | R126     | 2007-000856                 | R-CHIP;4.3KOHM,1%,1/10W,DA,TP,2012            | .....5   | R90         | 2007-000757                         | R-CHIP;330KOHM,5%,1/10W,DA,TP,2012        |
| .....5   | R127     | 2007-000109                 | R-CHIP;1Mohm,5%,1/16W,DA,TP,1608              | .....5   | R91         | 2007-000074                         | R-CHIP;100ohm,5%,1/16W,DA,TP,1608         |
| .....5   | R128     | 2007-000123                 | R-CHIP;1.5Kohm,5%,1/16W,DA,TP,1608            | .....5   | R92         | 2007-000090                         | R-CHIP;10KOHM,5%,1/16W,DA,TP,1608         |
| .....5   | R129     | 2007-000072                 | R-CHIP;47ohm,5%,1/16W,DA,TP,1608              | .....5   | R93         | 2007-000090                         | R-CHIP;10KOHM,5%,1/16W,DA,TP,1608         |
| .....5   | R133     | 2007-000084                 | R-CHIP;4.7Kohm,5%,1/16W,DA,TP,1608            | .....5   | R94         | 2007-000078                         | R-CHIP;1Kohm,5%,1/16W,DA,TP,1608          |
| .....5   | R134     | 2007-000072                 | R-CHIP;47ohm,5%,1/16W,DA,TP,1608              | .....5   | R95         | 2007-000704                         | R-CHIP;3.6Kohm,5%,1/16W,DA,TP,1608        |
| .....5   | R135     | 2007-000072                 | R-CHIP;47ohm,5%,1/16W,DA,TP,1608              | .....5   | R96         | 2007-000090                         | R-CHIP;10KOHM,5%,1/16W,DA,TP,1608         |
| .....5   | R136     | 2007-000072                 | R-CHIP;47ohm,5%,1/16W,DA,TP,1608              | .....5   | R97         | 2007-000090                         | R-CHIP;10KOHM,5%,1/16W,DA,TP,1608         |
| .....5   | R137     | 2007-000402                 | R-CHIP;150ohm,5%,1/16W,DA,TP,1608             | .....5   | R98         | 2007-000078                         | R-CHIP;1Kohm,5%,1/16W,DA,TP,1608          |
| .....5   | R138     | 2007-000402                 | R-CHIP;150ohm,5%,1/16W,DA,TP,1608             | .....5   | R99         | 2007-000704                         | R-CHIP;3.6Kohm,5%,1/16W,DA,TP,1608        |
| .....5   | R139     | 2007-000402                 | R-CHIP;150ohm,5%,1/16W,DA,TP,1608             | .....5   | RN01        | 2011-000585                         | R-NETWORK;47ohm,5%,63mW,L,CHIP,8P,TP      |
| .....5   | R15      | 2007-000072                 | R-CHIP;47ohm,5%,1/16W,DA,TP,1608              | .....5   | RN02        | 2011-000585                         | R-NETWORK;47ohm,5%,63mW,L,CHIP,8P,TP      |
| .....5   | R16      | 2007-000074                 | R-CHIP;100ohm,5%,1/16W,DA,TP,1608             | .....5   | RN03        | 2011-000585                         | R-NETWORK;47ohm,5%,63mW,L,CHIP,8P,TP      |
| .....5   | R17      | 2007-000074                 | R-CHIP;100ohm,5%,1/16W,DA,TP,1608             | .....5   | RN04        | 2011-000585                         | R-NETWORK;47ohm,5%,63mW,L,CHIP,8P,TP      |
| .....5   | R20      | 2007-000074                 | R-CHIP;100ohm,5%,1/16W,DA,TP,1608             | .....5   | RN05        | 2011-000585                         | R-NETWORK;47ohm,5%,63mW,L,CHIP,8P,TP      |
| .....5   | R24      | 2007-000072                 | R-CHIP;47ohm,5%,1/16W,DA,TP,1608              | .....5   | RN06        | 2011-000585                         | R-NETWORK;47ohm,5%,63mW,L,CHIP,8P,TP      |
| .....5   | R25      | 2007-000070                 | R-CHIP;0ohm,5%,1/16W,DA,TP,1608               | .....3   | AA95-03019A | ASSY SUB-PCB,PRO-SCAN;HCM4215W,P55A |   |
| .....5   | R26      | 2007-001167                 | R-CHIP;75ohm,5%,1/16W,DA,TP,1608              | .....4   | CN01        | 3703-001124                         | CONNECTOR-DIN;32P,2R,MALE,ANGLE,AUF       |
| .....5   | R27      | 2007-001167                 | R-CHIP;75ohm,5%,1/16W,DA,TP,1608              | .....4   | CN02        | 3703-001124                         | CONNECTOR-DIN;32P,2R,MALE,ANGLE,AUF       |
| .....5   | R28      | 2007-000122                 | R-CHIP;1.2Kohm,5%,1/16W,DA,TP,1608            | .....4   | CN03        | 3711-001164                         | CONNECTOR-HEADER;BOX,9P,1R,2.5mm,ANGLE,-  |
| .....5   | R29      | 2007-000122                 | R-CHIP;1.2Kohm,5%,1/16W,DA,TP,1608            | .....4   | EX01        | 2801-004019                         | CRYSTAL-UNIT;20.25MHZ,30ppm,28-AAAM,13pF, |
| .....5   | R30      | 2007-000028                 | R-CHIP;390OHM,5%,1/10W,DA,TP,2012             | .....4   | FC58        | 2309-000138                         | C-FILM,PE-PPF;100nF,50V,TP,20x16x8.5,     |
| .....5   | R31      | 2007-000028                 | R-CHIP;390OHM,5%,1/10W,DA,TP,2012             | .....4   | FC59        | 2305-000704                         | C-FILM,MPEF;100nF,5%,250V,TP,16.5x10.3x5  |
| .....5   | R32      | 2007-000119                 | R-CHIP;560ohm,5%,1/16W,DA,TP,1608             | .....4   | FX01        | 2802-001177                         | RESONATOR-CERAMIC;2.696MHZ,0.4%,BK,10X4.  |
| .....5   | R33      | 2007-000124                 | R-CHIP;2.2Kohm,5%,1/16W,DA,TP,1608            | .....4   | SX01        | 2802-001179                         | RESONATOR-CERAMIC;4MHZ,0.5%,BK,8X3X5.5MM  |
| .....5   | R34      | 2007-000122                 | R-CHIP;1.2Kohm,5%,1/16W,DA,TP,1608            | .....4   | AA97-07660A | ASSY SMD;0, , , ,                   |   |
| .....5   | R35      | 2007-000028                 | R-CHIP;390OHM,5%,1/10W,DA,TP,2012             | .....5   | CC49        | 2402-001070                         | C-AL,SMD;470uF,20%,16V,GP,TP,10x10.2,-    |
| .....5   | R36      | 2007-000028                 | R-CHIP;390OHM,5%,1/10W,DA,TP,2012             | .....5   | CL07        | 2703-000398                         | INDUCTOR-SMD;10uH,10%,3.2x2.5x2.2mm       |
| .....5   | R37      | 2007-000078                 | R-CHIP;1Kohm,5%,1/16W,DA,TP,1608              | .....5   | CR83        | 2007-000074                         | R-CHIP;100ohm,5%,1/16W,DA,TP,1608         |
| .....5   | R38      | 2007-000078                 | R-CHIP;1Kohm,5%,1/16W,DA,TP,1608              | .....5   | CR84        | 2007-000074                         | R-CHIP;100ohm,5%,1/16W,DA,TP,1608         |
| .....5   | R39      | 2007-000078                 | R-CHIP;1Kohm,5%,1/16W,DA,TP,1608              | .....5   | EC01        | 2203-000181                         | C-CERAMIC,CHIP;100nF,+80-20%,25V,Y5V,TP,  |
| .....5   | R40      | 2007-000078                 | R-CHIP;1Kohm,5%,1/16W,DA,TP,1608              | .....5   | EC02        | 2203-000181                         | C-CERAMIC,CHIP;100nF,+80-20%,25V,Y5V,TP,  |
| .....5   | R41      | 2007-000078                 | R-CHIP;1Kohm,5%,1/16W,DA,TP,1608              | .....5   | EC03        | 2203-000181                         | C-CERAMIC,CHIP;100nF,+80-20%,25V,Y5V,TP,  |
| .....5   | R42      | 2007-000078                 | R-CHIP;1Kohm,5%,1/16W,DA,TP,1608              | .....5   | EC04        | 2203-000181                         | C-CERAMIC,CHIP;100nF,+80-20%,25V,Y5V,TP,  |
| .....5   | R43      | 2007-000078                 | R-CHIP;1Kohm,5%,1/16W,DA,TP,1608              | .....5   | EC07        | 2203-000975                         | C-CERAMIC,CHIP;47nF,10%,25V,X7R,TP,1608,  |
| .....5   | R44      | 2007-000078                 | R-CHIP;1Kohm,5%,1/16W,DA,TP,1608              | .....5   | EC09        | 2203-000575                         | C-CERAMIC,CHIP;220NF,10%,25V,X7R,TP,2012  |
| .....5   | R45      | 2007-000072                 | R-CHIP;47ohm,5%,1/16W,DA,TP,1608              | .....5   | EC10        | 2203-000575                         | C-CERAMIC,CHIP;220NF,10%,25V,X7R,TP,2012  |
| .....5   | R46      | 2007-000072                 | R-CHIP;47ohm,5%,1/16W,DA,TP,1608              | .....5   | EC11        | 2203-000575                         | C-CERAMIC,CHIP;220NF,10%,25V,X7R,TP,2012  |

Electrical Parts List

| Loc. No. | Code No. | Description ; Specification                          | Remark | Loc. No. | Code No. | Description ; Specification                          | Remark |
|----------|----------|--|--------|----------|----------|--|--------|
| .....5   | EC12     | 2203-000181 C-CERAMIC,CHIP;100nF,+80-20%,25V,Y5V,TP, |        | .....5   | ER91     | 2007-000084 R-CHIP;4.7Kohm,5%,1/16W,DA,TP,1608       |        |
| .....5   | EC13     | 2203-000181 C-CERAMIC,CHIP;100nF,+80-20%,25V,Y5V,TP, |        | .....5   | ER92     | 2007-000084 R-CHIP;4.7Kohm,5%,1/16W,DA,TP,1608       |        |
| .....5   | EC14     | 2203-000975 C-CERAMIC,CHIP;47nF,10%,25V,X7R,TP,1608, |        | .....5   | FC01     | 2203-000440 C-CERAMIC,CHIP;1nF,10%,50V,X7R,TP,1608,- |        |
| .....5   | EC15     | 2203-000975 C-CERAMIC,CHIP;47nF,10%,25V,X7R,TP,1608, |        | .....5   | FC02     | 2203-000440 C-CERAMIC,CHIP;1nF,10%,50V,X7R,TP,1608,- |        |
| .....5   | EC16     | 2203-000975 C-CERAMIC,CHIP;47nF,10%,25V,X7R,TP,1608, |        | .....5   | FC03     | 2203-000181 C-CERAMIC,CHIP;100nF,+80-20%,25V,Y5V,TP, |        |
| .....5   | EC17     | 2203-000181 C-CERAMIC,CHIP;100nF,+80-20%,25V,Y5V,TP, |        | .....5   | FC04     | 2402-001042 C-AL,SMD;100uF,20%,16V,GP,TP,6.6x6.6x5.4 |        |
| .....5   | EC18     | 2203-000975 C-CERAMIC,CHIP;47nF,10%,25V,X7R,TP,1608, |        | .....5   | FC05     | 2203-000181 C-CERAMIC,CHIP;100nF,+80-20%,25V,Y5V,TP, |        |
| .....5   | EC19     | 2203-000975 C-CERAMIC,CHIP;47nF,10%,25V,X7R,TP,1608, |        | .....5   | FC06     | 2402-001049 C-AL,CHIP;10uF,20%,16V,GP,TP,3.3x3.3x5.4 |        |
| .....5   | EC20     | 2203-000975 C-CERAMIC,CHIP;47nF,10%,25V,X7R,TP,1608, |        | .....5   | FC07     | 2203-000491 C-CERAMIC,CHIP;2.2nF,10%,50V,X7R,TP,1608 |        |
| .....5   | EC21     | 2203-000975 C-CERAMIC,CHIP;47nF,10%,25V,X7R,TP,1608, |        | .....5   | FC08     | 2203-002494 C-CERAMIC,CHIP;470nF,10%,16V,X7R,TP,2012 |        |
| .....5   | EC22     | 2203-000975 C-CERAMIC,CHIP;47nF,10%,25V,X7R,TP,1608, |        | .....5   | FC09     | 2402-000170 C-AL,SMD;1uF,20%,50V,GP,TP,4.3x4.3x5.4,  |        |
| .....5   | EC23     | 2203-000975 C-CERAMIC,CHIP;47nF,10%,25V,X7R,TP,1608, |        | .....5   | FC10     | 2203-000181 C-CERAMIC,CHIP;100nF,+80-20%,25V,Y5V,TP, |        |
| .....5   | EC24     | 2203-000975 C-CERAMIC,CHIP;47nF,10%,25V,X7R,TP,1608, |        | .....5   | FC11     | 2203-000181 C-CERAMIC,CHIP;100nF,+80-20%,25V,Y5V,TP, |        |
| .....5   | EC25     | 2203-000181 C-CERAMIC,CHIP;100nF,+80-20%,25V,Y5V,TP, |        | .....5   | FC12     | 2402-001042 C-AL,SMD;100uF,20%,16V,GP,TP,6.6x6.6x5.4 |        |
| .....5   | EC27     | 2203-000784 C-CERAMIC,CHIP;0.33nF,5%,50V,NPO,TP,2012 |        | .....5   | FC21     | 2203-000181 C-CERAMIC,CHIP;100nF,+80-20%,25V,Y5V,TP, |        |
| .....5   | EC30     | 2007-001166 R-CHIP;750HM,5%,1/10W,DA,TP,2012         |        | .....5   | FC22     | 2203-000181 C-CERAMIC,CHIP;100nF,+80-20%,25V,Y5V,TP, |        |
| .....5   | EC31     | 2007-001166 R-CHIP;750HM,5%,1/10W,DA,TP,2012         |        | .....5   | FC23     | 2203-000181 C-CERAMIC,CHIP;100nF,+80-20%,25V,Y5V,TP, |        |
| .....5   | EC32     | 2203-005384 C-CERAMIC,CHIP;4700nF,+80-20%,10V,Y5V,TP |        | .....5   | FC24     | 2203-000181 C-CERAMIC,CHIP;100nF,+80-20%,25V,Y5V,TP, |        |
| .....5   | EC33     | 2203-005384 C-CERAMIC,CHIP;4700nF,+80-20%,10V,Y5V,TP |        | .....5   | FC25     | 2203-000181 C-CERAMIC,CHIP;100nF,+80-20%,25V,Y5V,TP, |        |
| .....5   | EC34     | 2203-005384 C-CERAMIC,CHIP;4700nF,+80-20%,10V,Y5V,TP |        | .....5   | FC26     | 2203-000181 C-CERAMIC,CHIP;100nF,+80-20%,25V,Y5V,TP, |        |
| .....5   | EC35     | 2203-000681 C-CERAMIC,CHIP;0.027nF,5%,50V,NPO,TP,160 |        | .....5   | FC27     | 2203-002494 C-CERAMIC,CHIP;470nF,10%,16V,X7R,TP,2012 |        |
| .....5   | EC36     | 2203-000681 C-CERAMIC,CHIP;0.027nF,5%,50V,NPO,TP,160 |        | .....5   | FC28     | 2203-002494 C-CERAMIC,CHIP;470nF,10%,16V,X7R,TP,2012 |        |
| .....5   | EC37     | 2203-000681 C-CERAMIC,CHIP;0.027nF,5%,50V,NPO,TP,160 |        | .....5   | FC29     | 2402-000173 C-AL,SMD;4.7uF,20%,35V,GP,TP,4.3x4.3x5.4 |        |
| .....5   | EC61     | 2203-000181 C-CERAMIC,CHIP;100nF,+80-20%,25V,Y5V,TP, |        | .....5   | FC30     | 2203-000181 C-CERAMIC,CHIP;100nF,+80-20%,25V,Y5V,TP, |        |
| .....5   | EC62     | 2203-000181 C-CERAMIC,CHIP;100nF,+80-20%,25V,Y5V,TP, |        | .....5   | FC31     | 2402-001070 C-AL,SMD;470uF,20%,16V,GP,TP,10x10,2-    |        |
| .....5   | EC63     | 2203-000626 C-CERAMIC,CHIP;0.022nF,5%,50V,NPO,TP,160 |        | .....5   | FC32     | 2203-000181 C-CERAMIC,CHIP;100nF,+80-20%,25V,Y5V,TP, |        |
| .....5   | EC64     | 2203-000626 C-CERAMIC,CHIP;0.022nF,5%,50V,NPO,TP,160 |        | .....5   | FC41     | 2203-000181 C-CERAMIC,CHIP;100nF,+80-20%,25V,Y5V,TP, |        |
| .....5   | EC65     | 2203-000181 C-CERAMIC,CHIP;100nF,+80-20%,25V,Y5V,TP, |        | .....5   | FC42     | 2203-000181 C-CERAMIC,CHIP;100nF,+80-20%,25V,Y5V,TP, |        |
| .....5   | EC66     | 2203-000181 C-CERAMIC,CHIP;100nF,+80-20%,25V,Y5V,TP, |        | .....5   | FC43     | 2203-000181 C-CERAMIC,CHIP;100nF,+80-20%,25V,Y5V,TP, |        |
| .....5   | EC67     | 2203-000181 C-CERAMIC,CHIP;100nF,+80-20%,25V,Y5V,TP, |        | .....5   | FC44     | 2203-000181 C-CERAMIC,CHIP;100nF,+80-20%,25V,Y5V,TP, |        |
| .....5   | EC68     | 2203-000181 C-CERAMIC,CHIP;100nF,+80-20%,25V,Y5V,TP, |        | .....5   | FC45     | 2402-001042 C-AL,SMD;100uF,20%,16V,GP,TP,6.6x6.6x5.4 |        |
| .....5   | EC69     | 2203-000181 C-CERAMIC,CHIP;100nF,+80-20%,25V,Y5V,TP, |        | .....5   | FC46     | 2203-002494 C-CERAMIC,CHIP;470nF,10%,16V,X7R,TP,2012 |        |
| .....5   | EC70     | 2203-000181 C-CERAMIC,CHIP;100nF,+80-20%,25V,Y5V,TP, |        | .....5   | FC47     | 2203-000575 C-CERAMIC,CHIP;220nF,10%,25V,X7R,TP,2012 |        |
| .....5   | EL01     | 2703-000274 INDUCTOR-SMD;2.2uH,10%,1.25x2x0.85mm     |        | .....5   | FC48     | 2203-002494 C-CERAMIC,CHIP;470nF,10%,16V,X7R,TP,2012 |        |
| .....5   | EL02     | 2703-000274 INDUCTOR-SMD;2.2uH,10%,1.25x2x0.85mm     |        | .....5   | FC49     | 2203-000891 C-CERAMIC,CHIP;4.7nF,10%,50V,X7R,TP,2012 |        |
| .....5   | EL03     | 2703-000274 INDUCTOR-SMD;2.2uH,10%,1.25x2x0.85mm     |        | .....5   | FC50     | 2203-001680 C-CERAMIC,CHIP;68nF,20%,50V,Z5U,TP,2012  |        |
| .....5   | EL04     | 2703-000274 INDUCTOR-SMD;2.2uH,10%,1.25x2x0.85mm     |        | .....5   | FC52     | 2203-000206 C-CERAMIC,CHIP;100nF,10%,50V,X7R,TP,2012 |        |
| .....5   | EL05     | 2703-000274 INDUCTOR-SMD;2.2uH,10%,1.25x2x0.85mm     |        | .....5   | FC53     | 2203-000206 C-CERAMIC,CHIP;100nF,10%,50V,X7R,TP,2012 |        |
| .....5   | EL06     | 2703-000274 INDUCTOR-SMD;2.2uH,10%,1.25x2x0.85mm     |        | .....5   | FC54     | 2203-000257 C-CERAMIC,CHIP;10nF,10%,50V,X7R,TP,1608  |        |
| .....5   | EL07     | 2703-000274 INDUCTOR-SMD;2.2uH,10%,1.25x2x0.85mm     |        | .....5   | FC55     | 2203-000181 C-CERAMIC,CHIP;100nF,+80-20%,25V,Y5V,TP, |        |
| .....5   | EL08     | 2703-000274 INDUCTOR-SMD;2.2uH,10%,1.25x2x0.85mm     |        | .....5   | FC57     | 2203-000440 C-CERAMIC,CHIP;1nF,10%,50V,X7R,TP,1608,- |        |
| .....5   | EL09     | 3301-001324 CORE-FERRITE BEAD;AB,150HM,2X1.25X0.9MM, |        | .....5   | FC60     | 2402-000173 C-AL,SMD;4.7uF,20%,35V,GP,TP,4.3x4.3x5.4 |        |
| .....5   | EQ11     | 0505-000110 FET-SILICON;2N7002,N,60V,115MA,7.50HM,0. |        | .....5   | FC61     | 2203-000181 C-CERAMIC,CHIP;100nF,+80-20%,25V,Y5V,TP, |        |
| .....5   | EQ12     | 0505-000110 FET-SILICON;2N7002,N,60V,115MA,7.50HM,0. |        | .....5   | FC62     | 2402-001042 C-AL,SMD;100uF,20%,16V,GP,TP,6.6x6.6x5.4 |        |
| .....5   | EQ13     | 0501-000344 TR-SMALL SIGNAL;KSC1623-G,NPN,200mW,SOT- |        | .....5   | FC63     | 2402-001042 C-AL,SMD;100uF,20%,16V,GP,TP,6.6x6.6x5.4 |        |
| .....5   | EQ14     | 0501-000344 TR-SMALL SIGNAL;KSC1623-G,NPN,200mW,SOT- |        | .....5   | FC64     | 2203-000181 C-CERAMIC,CHIP;100nF,+80-20%,25V,Y5V,TP, |        |
| .....5   | EQ15     | 0501-000344 TR-SMALL SIGNAL;KSC1623-G,NPN,200mW,SOT- |        | .....5   | FC65     | 2402-001049 C-AL,CHIP;10uF,20%,16V,GP,TP,3.3x3.3x5.4 |        |
| .....5   | ER03     | 2007-001166 R-CHIP;750HM,5%,1/10W,DA,TP,2012         |        | .....5   | FD01     | 0401-000133 DIODE-SWITCHING;RLS4148,100V,200MA,SOD-8 |        |
| .....5   | ER04     | 2007-000070 R-CHIP;0ohm,5%,1/16W,DA,TP,1608          |        | .....5   | FD02     | 0401-000133 DIODE-SWITCHING;RLS4148,100V,200MA,SOD-8 |        |
| .....5   | ER05     | 2007-000070 R-CHIP;0ohm,5%,1/16W,DA,TP,1608          |        | .....5   | FD03     | 0403-001117 DIODE-ZENER;RL212B,5%,500mW,LL-34,TP     |        |
| .....5   | ER06     | 2007-000070 R-CHIP;0ohm,5%,1/16W,DA,TP,1608          |        | .....5   | FD04     | 0403-001117 DIODE-ZENER;RL212B,5%,500mW,LL-34,TP     |        |
| .....5   | ER08     | 2007-000290 R-CHIP;1000HM,5%,1/10W,DA,TP,2012        |        | .....5   | FD05     | 0403-001117 DIODE-ZENER;RL212B,5%,500mW,LL-34,TP     |        |
| .....5   | ER09     | 2007-001166 R-CHIP;750HM,5%,1/10W,DA,TP,2012         |        | .....5   | FD06     | 0403-001117 DIODE-ZENER;RL212B,5%,500mW,LL-34,TP     |        |
| .....5   | ER10     | 2007-001166 R-CHIP;750HM,5%,1/10W,DA,TP,2012         |        | .....5   | FD07     | 0401-000133 DIODE-SWITCHING;RLS4148,100V,200MA,SOD-8 |        |
| .....5   | ER11     | 2007-001166 R-CHIP;750HM,5%,1/10W,DA,TP,2012         |        | .....5   | FD08     | 0401-000133 DIODE-SWITCHING;RLS4148,100V,200MA,SOD-8 |        |
| .....5   | ER12     | 2007-001166 R-CHIP;750HM,5%,1/10W,DA,TP,2012         |        | .....5   | FD09     | 0401-000133 DIODE-SWITCHING;RLS4148,100V,200MA,SOD-8 |        |
| .....5   | ER13     | 2007-000070 R-CHIP;0ohm,5%,1/16W,DA,TP,1608          |        | .....5   | FD10     | 0401-000133 DIODE-SWITCHING;RLS4148,100V,200MA,SOD-8 |        |
| .....5   | ER14     | 2007-001166 R-CHIP;750HM,5%,1/10W,DA,TP,2012         |        | .....5   | FD11     | 0403-001016 DIODE-ZENER;RL26.2B,6.2V,5.96-6.27V,400m |        |
| .....5   | ER15     | 2007-000290 R-CHIP;1000HM,5%,1/10W,DA,TP,2012        |        | .....5   | FD12     | 0403-000746 DIODE-ZENER;RL23.9B,3.9V,3.89-4.16V,400m |        |
| .....5   | ER16     | 2007-000290 R-CHIP;1000HM,5%,1/10W,DA,TP,2012        |        | .....5   | FD13     | 0401-000133 DIODE-SWITCHING;RLS4148,100V,200MA,SOD-8 |        |
| .....5   | ER17     | 2007-000070 R-CHIP;0ohm,5%,1/16W,DA,TP,1608          |        | .....5   | FD14     | 0401-000133 DIODE-SWITCHING;RLS4148,100V,200MA,SOD-8 |        |
| .....5   | ER18     | 2007-000070 R-CHIP;0ohm,5%,1/16W,DA,TP,1608          |        | .....5   | FD15     | 0401-000133 DIODE-SWITCHING;RLS4148,100V,200MA,SOD-8 |        |
| .....5   | ER19     | 2007-000070 R-CHIP;0ohm,5%,1/16W,DA,TP,1608          |        | .....5   | FD16     | 0401-000133 DIODE-SWITCHING;RLS4148,100V,200MA,SOD-8 |        |
| .....5   | ER20     | 2007-000097 R-CHIP;47Kohm,5%,1/16W,DA,TP,1608        |        | .....5   | FD17     | 0401-000133 DIODE-SWITCHING;RLS4148,100V,200MA,SOD-8 |        |
| .....5   | ER21     | 2007-000097 R-CHIP;47Kohm,5%,1/16W,DA,TP,1608        |        | .....5   | FLO1     | 2703-001070 INDUCTOR-SMD;100uH,10%,4.5x3.2x3.2mm     |        |
| .....5   | ER22     | 2007-000097 R-CHIP;47Kohm,5%,1/16W,DA,TP,1608        |        | .....5   | FQ02     | 0501-000280 TR-SMALL SIGNAL;KSA1182,PNP,150mW,SOT-23 |        |
| .....5   | ER23     | 2007-000097 R-CHIP;47Kohm,5%,1/16W,DA,TP,1608        |        | .....5   | FQ03     | 0501-000280 TR-SMALL SIGNAL;KSA1182,PNP,150mW,SOT-23 |        |
| .....5   | ER24     | 2007-000097 R-CHIP;47Kohm,5%,1/16W,DA,TP,1608        |        | .....5   | FQ04     | 0501-000280 TR-SMALL SIGNAL;KSA1182,PNP,150mW,SOT-23 |        |
| .....5   | ER25     | 2007-000097 R-CHIP;47Kohm,5%,1/16W,DA,TP,1608        |        | .....5   | FQ05     | 0501-000344 TR-SMALL SIGNAL;KSC1623-G,NPN,200mW,SOT- |        |
| .....5   | ER26     | 2007-000931 R-CHIP;4700HM,5%,1/10W,DA,TP,2012        |        | .....5   | FQ06     | 0501-000344 TR-SMALL SIGNAL;KSC1623-G,NPN,200mW,SOT- |        |
| .....5   | ER27     | 2007-000931 R-CHIP;4700HM,5%,1/10W,DA,TP,2012        |        | .....5   | FQ07     | 0501-000727 TR-SMALL SIGNAL;BC848C,NPN,310mW,SOT-23, |        |
| .....5   | ER28     | 2007-000931 R-CHIP;4700HM,5%,1/10W,DA,TP,2012        |        | .....5   | FQ08     | 0501-000344 TR-SMALL SIGNAL;KSC1623-G,NPN,200mW,SOT- |        |
| .....5   | ER29     | 2007-000070 R-CHIP;0ohm,5%,1/16W,DA,TP,1608          |        | .....5   | FQ09     | 0501-000344 TR-SMALL SIGNAL;KSC1623-G,NPN,200mW,SOT- |        |
| .....5   | ER82     | 2007-000074 R-CHIP;100ohm,5%,1/16W,DA,TP,1608        |        | .....5   | FQ12     | 0501-000344 TR-SMALL SIGNAL;KSC1623-G,NPN,200mW,SOT- |        |
| .....5   | ER83     | 2007-000074 R-CHIP;100ohm,5%,1/16W,DA,TP,1608        |        | .....5   | FQ13     | 0501-000280 TR-SMALL SIGNAL;KSA1182,PNP,150mW,SOT-23 |        |
| .....5   | ER84     | 2007-000074 R-CHIP;100ohm,5%,1/16W,DA,TP,1608        |        | .....5   | FRO1     | 2007-000074 R-CHIP;100ohm,5%,1/16W,DA,TP,1608        |        |
| .....5   | ER90     | 2007-000029 R-CHIP;00HM,5%,1/10W,DA,TP,2012          |        | .....5   | FRO2     | 2007-000074 R-CHIP;100ohm,5%,1/16W,DA,TP,1608        |        |



| Loc. No. | Code No. | Description ; Specification | Remark                                   | Loc. No. | Code No. | Description ; Specification | Remark                                   |   |
|----------|----------|-----------------------------|--|----------|----------|-----------------------------|--|---|
| .....5   | FR03     | 2007-000074                 | R-CHIP;100ohm,5%,1/16W,DA,TP,1608        | .....5   | PC09     | 2402-001049                 | C-AL,CHIP;10uf,20%,16V,GP,TP;3.3x3.3x5.4 |   |
| .....5   | FR07     | 2007-000070                 | R-CHIP;0ohm,5%,1/16W,DA,TP,1608          | .....5   | PC10     | 2402-001049                 | C-AL,CHIP;10uf,20%,16V,GP,TP;3.3x3.3x5.4 |   |
| .....5   | FR08     | 2007-000074                 | R-CHIP;100ohm,5%,1/16W,DA,TP,1608        | .....5   | PC11     | 2203-000181                 | C-CERAMIC,CHIP;100nF,+80-20% 25V,Y5V,TP, |   |
| .....5   | FR09     | 2007-000090                 | R-CHIP;10KOHM,5%,1/16W,DA,TP,1608        | .....5   | PC12     | 2402-001049                 | C-AL,CHIP;10uf,20%,16V,GP,TP;3.3x3.3x5.4 |   |
| .....5   | FR10     | 2007-000210                 | R-CHIP;1.1KOHM,5%,1/10W,DA,TP,2012       | .....5   | PC13     | 2203-000181                 | C-CERAMIC,CHIP;100nF,+80-20% 25V,Y5V,TP, |   |
| .....5   | FR11     | 2007-000210                 | R-CHIP;1.1KOHM,5%,1/10W,DA,TP,2012       | .....5   | PC14     | 2203-000181                 | C-CERAMIC,CHIP;100nF,+80-20% 25V,Y5V,TP, |   |
| .....5   | FR12     | 2007-000210                 | R-CHIP;1.1KOHM,5%,1/10W,DA,TP,2012       | .....5   | PC15     | 2203-000181                 | C-CERAMIC,CHIP;100nF,+80-20% 25V,Y5V,TP, |   |
| .....5   | FR13     | 2007-000210                 | R-CHIP;1.1KOHM,5%,1/10W,DA,TP,2012       | .....5   | PC16     | 2203-000181                 | C-CERAMIC,CHIP;100nF,+80-20% 25V,Y5V,TP, |   |
| .....5   | FR14     | 2007-000210                 | R-CHIP;1.1KOHM,5%,1/10W,DA,TP,2012       | .....5   | PC17     | 2203-000257                 | C-CERAMIC,CHIP;10nF,10%,50V,X7R,TP,1608  |   |
| .....5   | FR15     | 2007-000210                 | R-CHIP;1.1KOHM,5%,1/10W,DA,TP,2012       | .....5   | PC18     | 2402-000173                 | C-AL,SMD;4.7uf,20%,16V,GP,TP;6.6x6.6x5.4 |   |
| .....5   | FR16     | 2007-000074                 | R-CHIP;100ohm,5%,1/16W,DA,TP,1608        | .....5   | PC31     | 2203-000181                 | C-CERAMIC,CHIP;100nF,+80-20% 25V,Y5V,TP, |   |
| .....5   | FR17     | 2007-000074                 | R-CHIP;100ohm,5%,1/16W,DA,TP,1608        | .....5   | PC32     | 2402-000179                 | C-AL,SMD;47uf,20%,16V,GP,TP;6.6x6.6x5.4  |   |
| .....5   | FR18     | 2007-000074                 | R-CHIP;100ohm,5%,1/16W,DA,TP,1608        | .....5   | PCB      | AA41-00610A                 | PCB-DW-SRC;FR-4,4L,A,1.6T,180X245,2A,14  |   |
| .....5   | FR19     | 2007-000074                 | R-CHIP;100ohm,5%,1/16W,DA,TP,1608        | .....5   | PL01     | 3301-001082                 | CORE-FERRITE BEAD;AB,600HM,3,2X2.5X1.3MM |   |
| .....5   | FR20     | 2007-000074                 | R-CHIP;100ohm,5%,1/16W,DA,TP,1608        | .....5   | PL02     | 3301-001324                 | CORE-FERRITE BEAD;AB,150HM,2X1.25X0.9MM, |   |
| .....5   | FR21     | 2007-000074                 | R-CHIP;100ohm,5%,1/16W,DA,TP,1608        | .....5   | PL03     | 3301-001324                 | CORE-FERRITE BEAD;AB,150HM,2X1.25X0.9MM, |   |
| .....5   | FR22     | 2007-000090                 | R-CHIP;10KOHM,5%,1/16W,DA,TP,1608        | .....5   | PL04     | 3301-001324                 | CORE-FERRITE BEAD;AB,150HM,2X1.25X0.9MM, |   |
| .....5   | FR31     | 2007-000074                 | R-CHIP;100ohm,5%,1/16W,DA,TP,1608        | .....5   | PL05     | 3301-001324                 | CORE-FERRITE BEAD;AB,150HM,2X1.25X0.9MM, |   |
| .....5   | FR32     | 2007-000074                 | R-CHIP;100ohm,5%,1/16W,DA,TP,1608        | .....5   | PL06     | 3301-001324                 | CORE-FERRITE BEAD;AB,150HM,2X1.25X0.9MM, |   |
| .....5   | FR33     | 2007-000074                 | R-CHIP;100ohm,5%,1/16W,DA,TP,1608        | .....5   | PL07     | 3301-001186                 | CORE-FERRITE BEAD;AB,600ohm,3.2x1.6x1.3m |   |
| .....5   | FR34     | 2007-000074                 | R-CHIP;100ohm,5%,1/16W,DA,TP,1608        | .....5   | PL08     | 3301-001186                 | CORE-FERRITE BEAD;AB,600ohm,3.2x1.6x1.3m |   |
| .....5   | FR35     | 2007-000070                 | R-CHIP;0ohm,5%,1/16W,DA,TP,1608          | .....5   | P001     | 0501-000344                 | TR-SMALL SIGNAL;KSC1623-G,NPN,200mW,SOT- |   |
| .....5   | FR36     | 2007-000691                 | R-CHIP;3.3Mohm,5%,1/16W,DA,TP,1608       | .....5   | PR01     | 2007-000090                 | R-CHIP;10KOHM,5%,1/16W,DA,TP,1608        |   |
| .....5   | FR37     | 2007-000074                 | R-CHIP;100ohm,5%,1/16W,DA,TP,1608        | .....5   | PR02     | 2007-000097                 | R-CHIP;47Kohm,5%,1/16W,DA,TP,1608        |   |
| .....5   | FR38     | 2007-000074                 | R-CHIP;100ohm,5%,1/16W,DA,TP,1608        | .....5   | SC01     | 2203-002494                 | C-CERAMIC,CHIP;470nF,10%,16V,X7R,TP,2012 |   |
| .....5   | FR39     | 2007-000074                 | R-CHIP;100ohm,5%,1/16W,DA,TP,1608        | .....5   | SC02     | 2203-002494                 | C-CERAMIC,CHIP;470nF,10%,16V,X7R,TP,2012 |   |
| .....5   | FR40     | 2007-000080                 | R-CHIP;2Kohm,5%,1/16W,DA,TP,1608         | .....5   | SC03     | 2203-002494                 | C-CERAMIC,CHIP;470nF,10%,16V,X7R,TP,2012 |   |
| .....5   | FR41     | 2007-000086                 | R-CHIP;5.6Kohm,5%,1/16W,DA,TP,1608       | .....5   | SC04     | 2203-002494                 | C-CERAMIC,CHIP;470nF,10%,16V,X7R,TP,2012 |   |
| .....5   | FR42     | 2007-000086                 | R-CHIP;5.6Kohm,5%,1/16W,DA,TP,1608       | .....5   | SC05     | 2203-002494                 | C-CERAMIC,CHIP;470nF,10%,16V,X7R,TP,2012 |   |
| .....5   | FR43     | 2007-000869                 | R-CHIP;4.7Kohm,1%,1/16W,DA,TP,1608       | .....5   | SC06     | 2203-002494                 | C-CERAMIC,CHIP;470nF,10%,16V,X7R,TP,2012 |   |
| .....5   | FR44     | 2007-000084                 | R-CHIP;4.7Kohm,5%,1/16W,DA,TP,1608       | .....5   | SC07     | 2203-002494                 | C-CERAMIC,CHIP;470nF,10%,16V,X7R,TP,2012 |   |
| .....5   | FR45     | 2007-000084                 | R-CHIP;4.7Kohm,5%,1/16W,DA,TP,1608       | .....5   | SC08     | 2203-002494                 | C-CERAMIC,CHIP;470nF,10%,16V,X7R,TP,2012 |   |
| .....5   | FR46     | 2007-000493                 | R-CHIP;2.2KOHM,5%,1/10W,DA,TP,2012       | .....5   | SC09     | 2203-002494                 | C-CERAMIC,CHIP;470nF,10%,16V,X7R,TP,2012 |   |
| .....5   | FR47     | 2007-000493                 | R-CHIP;2.2KOHM,5%,1/10W,DA,TP,2012       | .....5   | SC10     | 2203-002494                 | C-CERAMIC,CHIP;470nF,10%,16V,X7R,TP,2012 |   |
| .....5   | FR53     | 2007-000074                 | R-CHIP;100ohm,5%,1/16W,DA,TP,1608        | .....5   | SC11     | 2402-000179                 | C-AL,SMD;47uf,20%,16V,GP,TP;6.6x6.6x5.4  |   |
| .....5   | FR54     | 2007-000074                 | R-CHIP;100ohm,5%,1/16W,DA,TP,1608        | .....5   | SC12     | 2203-000181                 | C-CERAMIC,CHIP;100nF,+80-20% 25V,Y5V,TP, |   |
| .....5   | FR55     | 2007-000074                 | R-CHIP;100ohm,5%,1/16W,DA,TP,1608        | .....5   | SC13     | 2203-000257                 | C-CERAMIC,CHIP;10nF,10%,50V,X7R,TP,1608  |   |
| .....5   | FR56     | 2007-000074                 | R-CHIP;100ohm,5%,1/16W,DA,TP,1608        | .....5   | SC14     | 2203-005809                 | C-CERAMIC,CHIP;100nF,10%,16V,X7R,TP,201  |   |
| .....5   | FR57     | 2007-000052                 | R-CHIP;10Kohm,1%,1/16W,DA,TP,1608        | .....5   | SC15     | 2203-000181                 | C-CERAMIC,CHIP;100nF,+80-20% 25V,Y5V,TP, |   |
| .....5   | FR58     | 2007-000092                 | R-CHIP;15Kohm,5%,1/16W,DA,TP,1608        | .....5   | SC16     | 2402-000179                 | C-AL,SMD;47uf,20%,16V,GP,TP;6.6x6.6x5.4  |   |
| .....5   | FR60     | 2007-000090                 | R-CHIP;10KOHM,5%,1/16W,DA,TP,1608        | .....5   | SC17     | 2203-000181                 | C-CERAMIC,CHIP;100nF,+80-20% 25V,Y5V,TP, |   |
| .....5   | FR62     | 2007-000082                 | R-CHIP;3.3Kohm,5%,1/16W,DA,TP,1608       | .....5   | SC18     | 2402-000179                 | C-AL,SMD;47uf,20%,16V,GP,TP;6.6x6.6x5.4  |   |
| .....5   | FR63     | 2007-000118                 | R-CHIP;390ohm,5%,1/16W,DA,TP,1608        | .....5   | SC19     | 2203-000181                 | C-CERAMIC,CHIP;100nF,+80-20% 25V,Y5V,TP, |   |
| .....5   | FR66     | 2007-000077                 | R-CHIP;470ohm,5%,1/16W,DA,TP,1608        | .....5   | SC20     | 2203-002494                 | C-CERAMIC,CHIP;470nF,10%,16V,X7R,TP,2012 |   |
| .....5   | FR67     | 2007-000074                 | R-CHIP;100ohm,5%,1/16W,DA,TP,1608        | .....5   | SC21     | 2203-002494                 | C-CERAMIC,CHIP;470nF,10%,16V,X7R,TP,2012 |   |
| .....5   | FR70     | 2007-000124                 | R-CHIP;2.2Kohm,5%,1/16W,DA,TP,1608       | .....5   | SC22     | 2203-002494                 | C-CERAMIC,CHIP;470nF,10%,16V,X7R,TP,2012 |   |
| .....5   | FR71     | 2007-000074                 | R-CHIP;100ohm,5%,1/16W,DA,TP,1608        | .....5   | SC23     | 2203-002494                 | C-CERAMIC,CHIP;470nF,10%,16V,X7R,TP,2012 |   |
| .....5   | FR72     | 2007-000081                 | R-CHIP;2.7Kohm,5%,1/16W,DA,TP,1608       | .....5   | SC24     | 2203-002494                 | C-CERAMIC,CHIP;470nF,10%,16V,X7R,TP,2012 |   |
| .....5   | FR73     | 2007-000082                 | R-CHIP;3.3Kohm,5%,1/16W,DA,TP,1608       | .....5   | SC25     | 2203-002494                 | C-CERAMIC,CHIP;470nF,10%,16V,X7R,TP,2012 |   |
| .....5   | FR74     | 2007-000074                 | R-CHIP;100ohm,5%,1/16W,DA,TP,1608        | .....5   | SC26     | 2203-002494                 | C-CERAMIC,CHIP;470nF,10%,16V,X7R,TP,2012 |   |
| .....5   | FR75     | 2007-000074                 | R-CHIP;100ohm,5%,1/16W,DA,TP,1608        | .....5   | SC31     | 2402-000179                 | C-AL,SMD;47uf,20%,16V,GP,TP;6.6x6.6x5.4  |   |
| .....5   | FR76     | 2007-000070                 | R-CHIP;0ohm,5%,1/16W,DA,TP,1608          | .....5   | SC32     | 2203-001656                 | C-CERAMIC,CHIP;0.47nF,5%,50V,NPO,TP,1608 |   |
| .....5   | FR77     | 2007-000941                 | R-CHIP;47KOHM,5%,1/10W,DA,TP,2012        | .....5   | SC33     | 2203-000257                 | C-CERAMIC,CHIP;10nF,10%,50V,X7R,TP,1608  |   |
| .....5   | FR78     | 2007-000297                 | R-CHIP;10KOHM,1%,1/10W,DA,TP,2012        | .....5   | SC34     | 2402-000179                 | C-AL,SMD;47uf,20%,16V,GP,TP;6.6x6.6x5.4  |   |
| .....5   | FR79     | 2007-000297                 | R-CHIP;10KOHM,1%,1/10W,DA,TP,2012        | .....5   | SC35     | 2203-000257                 | C-CERAMIC,CHIP;10nF,10%,50V,X7R,TP,1608  |   |
| .....5   | FR80     | 2007-000297                 | R-CHIP;10KOHM,1%,1/10W,DA,TP,2012        | .....5   | SC36     | 2402-000179                 | C-AL,SMD;47uf,20%,16V,GP,TP;6.6x6.6x5.4  |   |
| .....5   | FR81     | 2007-000074                 | R-CHIP;100ohm,5%,1/16W,DA,TP,1608        | .....5   | SC37     | 2203-000257                 | C-CERAMIC,CHIP;10nF,10%,50V,X7R,TP,1608  |   |
| .....5   | FR82     | 2007-000074                 | R-CHIP;100ohm,5%,1/16W,DA,TP,1608        | .....5   | SC38     | 2402-000179                 | C-AL,SMD;47uf,20%,16V,GP,TP;6.6x6.6x5.4  |   |
| .....5   | FR96     | 2007-000070                 | R-CHIP;0ohm,5%,1/16W,DA,TP,1608          | .....5   | SC39     | 2203-000257                 | C-CERAMIC,CHIP;10nF,10%,50V,X7R,TP,1608  |   |
| .....5   | IC01A    | 1204-001938                 | IC-DECODER;VSP9407B-B11,MQFP,80P,14X14MM | .....5   | SC40     | 2402-000179                 | C-AL,SMD;47uf,20%,16V,GP,TP;6.6x6.6x5.4  |   |
| .....5   | IC02     | 1204-001814                 | IC-SELECTOR;CXA2151Q,QFP,48P,144MIL,PLAS | S.N.A    | .....5   | SC41                        | 2203-000257                              | C-CERAMIC,CHIP;10nF,10%,50V,X7R,TP,1608 |
| .....5   | IC03     | 1001-001082                 | IC-VIDEO SWITCH;BA7657F,-,SOP,24P,300MIL | .....5   | SC42     | 2402-000179                 | C-AL,SMD;47uf,20%,16V,GP,TP;6.6x6.6x5.4  |   |
| .....5   | IC04     | 1204-001989                 | IC-VIDEO PROCESS;CXA2165Q,QFP,64P,20X14M | S.N.A    | .....5   | SC43                        | 2203-000257                              | C-CERAMIC,CHIP;10nF,10%,50V,X7R,TP,1608 |
| .....5   | IC05     | 1203-002186                 | IC-POS.FIXED REG.;18,DPAK,3P,240MIL,PLA  | .....5   | SC44     | 2402-000179                 | C-AL,SMD;47uf,20%,16V,GP,TP;6.6x6.6x5.4  |   |
| .....5   | IC06     | 1203-001211                 | IC-VOL. DETECTOR;7027,SOT-89,3P,-,PLASTI | .....5   | SC45     | 2203-000998                 | C-CERAMIC,CHIP;0.047nF,5%,50V,NPO,TP,160 |   |
| .....5   | IC11     | 1203-002302                 | IC-POS.FIXED REG.;78RM33D,D-PAK,3P,-,PL  | .....5   | SC46     | 2203-000998                 | C-CERAMIC,CHIP;0.047nF,5%,50V,NPO,TP,160 |   |
| .....5   | IC13     | 0801-000662                 | IC-CMOS LOGIC;74HC123,MULTIVIBATOR,SOP,1 | .....5   | SC47     | 2402-000179                 | C-AL,SMD;47uf,20%,16V,GP,TP;6.6x6.6x5.4  |   |
| .....5   | IC14     | 3301-001324                 | CORE-FERRITE BEAD;AB,150HM,2X1.25X0.9MM, | .....5   | SC48     | 2203-000181                 | C-CERAMIC,CHIP;100nF,+80-20% 25V,Y5V,TP, |   |
| .....5   | IC15     | 3301-001324                 | CORE-FERRITE BEAD;AB,150HM,2X1.25X0.9MM, | .....5   | SC49     | 2203-000998                 | C-CERAMIC,CHIP;0.047nF,5%,50V,NPO,TP,160 |   |
| .....5   | PC01     | 2402-000179                 | C-AL,SMD;47uf,20%,16V,GP,TP;6.6x6.6x5.4  | .....5   | SC50     | 2203-000998                 | C-CERAMIC,CHIP;0.047nF,5%,50V,NPO,TP,160 |   |
| .....5   | PC02     | 2203-000181                 | C-CERAMIC,CHIP;100nF,+80-20% 25V,Y5V,TP, | .....5   | SC51     | 2203-002494                 | C-CERAMIC,CHIP;470nF,10%,16V,X7R,TP,2012 |   |
| .....5   | PC03     | 2402-000179                 | C-AL,SMD;47uf,20%,16V,GP,TP;6.6x6.6x5.4  | .....5   | SC52     | 2203-002494                 | C-CERAMIC,CHIP;470nF,10%,16V,X7R,TP,2012 |   |
| .....5   | PC04     | 2203-000181                 | C-CERAMIC,CHIP;100nF,+80-20% 25V,Y5V,TP, | .....5   | SC53     | 2203-002494                 | C-CERAMIC,CHIP;470nF,10%,16V,X7R,TP,2012 |   |
| .....5   | PC05     | 2203-000181                 | C-CERAMIC,CHIP;100nF,+80-20% 25V,Y5V,TP, | .....5   | SC56     | 2203-000495                 | C-CERAMIC,CHIP;2.2nF,10%,50V,X7R,TP,2012 |   |
| .....5   | PC06     | 2402-000179                 | C-AL,SMD;47uf,20%,16V,GP,TP;6.6x6.6x5.4  | .....5   | SC57     | 2203-000495                 | C-CERAMIC,CHIP;2.2nF,10%,50V,X7R,TP,2012 |   |
| .....5   | PC07     | 2402-001070                 | C-AL,SMD;470uf,20%,16V,GP,TP;10x10.2,-   | .....5   | SC58     | 2203-000181                 | C-CERAMIC,CHIP;100nF,+80-20% 25V,Y5V,TP, |   |
| .....5   | PC08     | 2402-001070                 | C-AL,SMD;470uf,20%,16V,GP,TP;10x10.2,-   | .....5   | SLO1     | 3301-001324                 | CORE-FERRITE BEAD;AB,150HM,2X1.25X0.9MM, |   |

Electrical Parts List

| Loc. No. | Code No.    | Description ; Specification                          | Remark | Loc. No. | Code No.    | Description ; Specification                          | Remark  |
|----------|-------------|--|--------|----------|-------------|--|---|
| ....5    | SL02        | 3301-001186 CORE-FERRITE BEAD;AB,600ohm,3.2x1.6x1.3m |        | ....4    | DZ104       | 0402-000546 DIODE-RECTIFIER;TVR10G,400V,1.0A,DO-41,T |   |
| ....5    | SQ01        | 0501-000280 TR-SMALL SIGNAL;KSA1182,PNP,150mW,SOT-23 |        | ....4    | DZ105       | 0401-000005 DIODE-SWITCHING;1N4148,100V,200mA,DO-35, |   |
| ....5    | SR01        | 2007-000074 R-CHIP;100ohm,5%,1/16W,DA,TP,1608        |        | ....4    | DZ106       | 0401-000005 DIODE-SWITCHING;1N4148,100V,200mA,DO-35, |   |
| ....5    | SR02        | 2007-000074 R-CHIP;100ohm,5%,1/16W,DA,TP,1608        |        | ....4    | LZ101       | 2701-000002 INDUCTOR-AXIAL;100uH,10%,4.2x9.8mm       |   |
| ....5    | SR03        | 2007-000074 R-CHIP;100ohm,5%,1/16W,DA,TP,1608        |        | ....4    | PCB         | AA41-00611A PCB-VM;FR-1,1L,A,1.6T,245X245,6A,113X62  | S.N.A   |
| ....5    | SR04        | 2007-000074 R-CHIP;100ohm,5%,1/16W,DA,TP,1608        |        | ....4    | OZ103       | 0501-000283 TR-SMALL SIGNAL;KSA539,PNP,400mW,TO-92,T |   |
| ....5    | SR05        | 2007-000074 R-CHIP;100ohm,5%,1/16W,DA,TP,1608        |        | ....4    | OZ104       | 0501-000389 TR-SMALL SIGNAL;KSC815,NPN,400mW,TO-92,T |   |
| ....5    | SR06        | 2007-000074 R-CHIP;100ohm,5%,1/16W,DA,TP,1608        |        | ....4    | OZ105       | 0501-000389 TR-SMALL SIGNAL;KSC815,NPN,400mW,TO-92,T |   |
| ....5    | SR07        | 2007-000080 R-CHIP;2Kohm,5%,1/16W,DA,TP,1608         |        | ....4    | OZ106       | 0501-000389 TR-SMALL SIGNAL;KSC815,NPN,400mW,TO-92,T |   |
| ....5    | SR08        | 2007-000052 R-CHIP;10Kohm,1%,1/16W,DA,TP,1608        |        | ....4    | RFZ101      | 2008-001086 R-FUSIBLE(S);3.3ohm,5%,2W,AG,TP,3.9x12mm |   |
| ....5    | SR09        | 2007-000070 R-CHIP;0ohm,5%,1/16W,DA,TP,1608          |        | ....4    | RZ101       | 2001-000241 R-CARBON;1.5KOHM,5%,1/8W,AA,TP,1.8X3.2MM |   |
| ....5    | SR10        | 2007-000074 R-CHIP;100ohm,5%,1/16W,DA,TP,1608        |        | ....4    | RZ102       | 2001-000221 R-CARBON;1.2KOHM,5%,1/8W,AA,TP,1.8X3.2MM |   |
| ....5    | SR11        | 2007-000074 R-CHIP;100ohm,5%,1/16W,DA,TP,1608        |        | ....4    | RZ103       | 2003-000713 R-METAL OXIDE(S);47ohm,5%,2W,AF,TP,4x12m |   |
| ....5    | SR21        | 2007-000077 R-CHIP;470ohm,5%,1/16W,DA,TP,1608        |        | ....4    | RZ104       | 2001-001100 R-CARBON(S);2.7OHM,5%,1/2W,AA,TP,2.4X6.4 |   |
| ....5    | SR22        | 2007-000070 R-CHIP;0ohm,5%,1/16W,DA,TP,1608          |        | ....4    | RZ105       | 2001-001139 R-CARBON(S);39KOHM,5%,1/2W,AA,TP,2.4X6.4 |   |
| ....5    | SR23        | 2007-000309 R-CHIP;10ohm,5%,1/16W,DA,TP,1608         |        | ....4    | RZ106       | 2001-001139 R-CARBON(S);39KOHM,5%,1/2W,AA,TP,2.4X6.4 |   |
| ....5    | SR25        | 2007-000309 R-CHIP;10ohm,5%,1/16W,DA,TP,1608         |        | ....4    | RZ107       | 2001-000331 R-CARBON;1.2KOHM,5%,1/8W,AA,TP,1.8X3.2MM |   |
| ....5    | SR26        | 2007-000309 R-CHIP;10ohm,5%,1/16W,DA,TP,1608         |        | ....4    | RZ108       | 2001-000241 R-CARBON;1.5KOHM,5%,1/8W,AA,TP,1.8X3.2MM |   |
| ....5    | SR31        | 2007-000074 R-CHIP;100ohm,5%,1/16W,DA,TP,1608        |        | ....4    | RZ109       | 2001-000221 R-CARBON;1.2KOHM,5%,1/8W,AA,TP,1.8X3.2MM |   |
| ....5    | SR32        | 2007-000074 R-CHIP;100ohm,5%,1/16W,DA,TP,1608        |        | ....4    | RZ110       | 2001-001100 R-CARBON(S);2.7OHM,5%,1/2W,AA,TP,2.4X6.4 |   |
| ....5    | SR33        | 2007-000074 R-CHIP;100ohm,5%,1/16W,DA,TP,1608        |        | ....4    | RZ111       | 2003-000713 R-METAL OXIDE(S);47ohm,5%,2W,AF,TP,4x12m |   |
| ....5    | SR34        | 2007-000074 R-CHIP;100ohm,5%,1/16W,DA,TP,1608        |        | ....4    | RZ112       | 2003-002157 R-METAL OXIDE;220OHM,5%,2W,AG,TP,6X16MM  |   |
| ....5    | SR35        | 2007-000074 R-CHIP;100ohm,5%,1/16W,DA,TP,1608        |        | ....4    | RZ113       | 2003-002157 R-METAL OXIDE;220OHM,5%,2W,AG,TP,6X16MM  |   |
| ....5    | SR36        | 2007-001166 R-CHIP;750HM,5%,1/10W,DA,TP,2012         |        | ....4    | RZ114       | 2003-000532 R-METAL OXIDE(S);18ohm,5%,2W,AF,TP,4x12m |   |
| ....5    | SR37        | 2007-001166 R-CHIP;750HM,5%,1/10W,DA,TP,2012         |        | ....4    | RZ115       | 2001-000832 R-CARBON;510OHM,5%,1/8W,AA,TP,1.8X3.2MM  |   |
| ....5    | SR38        | 2007-001166 R-CHIP;750OHM,5%,1/10W,DA,TP,2012        |        | ....4    | RZ116       | 2001-000331 R-CARBON;1.2KOHM,5%,1/8W,AA,TP,1.8X3.2MM |   |
| ....5    | SR39        | 2007-001166 R-CHIP;750HM,5%,1/10W,DA,TP,2012         |        | ....4    | RZ117       | 2001-000258 R-CARBON;1.8KOHM,5%,1/8W,AA,TP,1.8X3.2MM |   |
| ....5    | SR40        | 2007-001166 R-CHIP;750HM,5%,1/10W,DA,TP,2012         |        | ....4    | RZ118       | 2001-000258 R-CARBON;1.8KOHM,5%,1/8W,AA,TP,1.8X3.2MM |   |
| ....5    | SR47        | 2007-000074 R-CHIP;100ohm,5%,1/16W,DA,TP,1608        |        | ....4    | RZ119       | 2001-000554 R-CARBON;270OHM,5%,1/8W,AA,TP,1.8X3.2MM  |   |
| ....5    | SR48        | 2007-000074 R-CHIP;100ohm,5%,1/16W,DA,TP,1608        |        | ....4    | RZ121       | 2001-000666 R-CARBON;330HM,5%,1/8W,AA,TP,1.8X3.2MM   |   |
| ....5    | SR49        | 2007-000074 R-CHIP;100ohm,5%,1/16W,DA,TP,1608        |        | ....4    | RZ122       | 2001-000019 R-CARBON(S);10OHM,5%,1/2W,AA,TP,2.4X6.4M |   |
| ....5    | SR53        | 2007-000074 R-CHIP;100ohm,5%,1/16W,DA,TP,1608        |        | ....4    | RZ123       | 2003-002157 R-METAL OXIDE;220OHM,5%,2W,AG,TP,6X16MM  |   |
| ....5    | SR73        | 2007-000258 R-CHIP;1.6KOHM,5%,1/10W,DA,TP,2012       |        | .2       | AA94-08270A | ASSY PCB MISC-DY JACK;COMMANDO                       | S.N.A   |
| ....5    | SR74        | 2007-000077 R-CHIP;470ohm,5%,1/16W,DA,TP,1608        |        | .3       | GT01        | AA60-40012D PIN-GT,ASSY;4P,T1.6.6-12.5-14MM,NYLON66  | S.N.A   |
| ....5    | SR75        | 2007-000290 R-CHIP;100OHM,5%,1/10W,DA,TP,2012        |        | .3       | GT05        | AA60-40012D PIN-GT,ASSY;4P,T1.6.6-12.5-14MM,NYLON66  | S.N.A   |
| ....5    | YR43        | 2007-000074 R-CHIP;100ohm,5%,1/16W,DA,TP,1608        |        | .3       | GT09        | AA60-40012D PIN-GT,ASSY;4P,T1.6.6-12.5-14MM,NYLON66  | S.N.A   |
| ....5    | YR44        | 2007-000074 R-CHIP;100ohm,5%,1/16W,DA,TP,1608        |        | .3       | GT13        | AA60-40012D PIN-GT,ASSY;4P,T1.6.6-12.5-14MM,NYLON66  | S.N.A   |
| ....5    | YR45        | 2007-000074 R-CHIP;100ohm,5%,1/16W,DA,TP,1608        |        | .3       | AA61-01197A | HOLDER-PCB,DY;COMANDO,ABS VO,BLK                     | S.N.A   |
| ....4    | 0202-000187 | SOLDER-WIRE FLUX;-RS60S,D1.2.63Sn/37Pb               | S.N.A  | .3       | AA97-07230N | ASSY AUTO;COMMANDO                                   | S.N.A   |
| ....4    | 0202-001167 | SOLDER-CREAM;RX3603-2330HO,S45A,PASTE,SN             | S.N.A  | ....4    | PCB         | AA41-00632A PCB-DY CONNECTION;FR-1,1L,A,1.6T,245X24  | S.N.A   |
| ....3    | AA63-00680A | SHIELD CASE;HERCULES TOP,SPT,TO.5,W140.              | S.N.A  | ....4    | R301        | 2001-001107 R-CARBON(S);220ohm,5%,1/2W,AA,TP,2.4x6.4 |   |
| ....3    | AA63-00610A | SHIELD CASE;COMMANDO,SPT,TO.5,W141.5,H1              | S.N.A  | ....4    | R302        | 2001-001107 R-CARBON(S);220ohm,5%,1/2W,AA,TP,2.4x6.4 |   |
| ....2    | AA94-08268A | ASSY PCB MISC-VM;COMMANDO                            | S.N.A  | ....4    | R303        | 2001-001107 R-CARBON(S);220ohm,5%,1/2W,AA,TP,2.4x6.4 |   |
| ....3    | CNZ101      | AA39-20055C LEAD CONNECTOR-ASSY;6P,YBNH025-06,67096  |        | ....3    |             | 0202-000187 SOLDER-WIRE FLUX;-RS60S,D1.2.63Sn/37Pb   | S.N.A   |
| ....3    | OZ101       | AA96-00243M ASSY H/S;-AMP,AA62-000450A,2SA1011,HERC  | S.N.A  | ....2    |             | AA94-08380A ASSY PCB MISC-SENSOR;SVP-55W9HD,P54A     | S.N.A   |
| ....4    | 0205-000129 | GREASE-SILICON;SC102,JAPAN                           | S.N.A  | ....3    | CN01        | 3711-000447 CONNECTOR-HEADER;3WALL,3P,1R,2.5mm,ANGLE |   |
| ....4    | 0502-000131 | TR-POWER;2SA1011-D,PNP,1.2W,TO-220,-60               |        | ....3    | Q01         | 0603-001098 PHOTO TR;NPN,20V,5V,20MA,50MW,ST         |   |
| ....4    | 6003-000335 | SCREW-TAPTITE;RH,+.2S,M3,L8,ZPC(YEL),SWR             | S.N.A  | ....3    |             | 0202-000187 SOLDER-WIRE FLUX;-RS60S,D1.2.63Sn/37Pb   | S.N.A   |
| ....4    | AA62-00045A | HEAT SINK-PS;-T1.0,-DREAM,-,-,-,-                    | S.N.A  | ....3    |             | AA97-07428A ASSY AUTO;0000                           | S.N.A   |
| ....3    | OZ102       | AA96-00243L ASSY H/S;-CRT,AA62-000450A,2SC2344,HERC  | S.N.A  | ....4    | PCB         | AA41-00741A PCB-SENSOR;SVP-55W9HD,FR-4,2L,A,1.6T,245 | S.N.A   |
| ....4    | 0205-000129 | GREASE-SILICON;SC102,JAPAN                           | S.N.A  | ....4    | R01         | 2001-000522 R-CARBON;2.2KOHM,5%,1/8W,AA,TP,1.8X3.2MM |   |
| ....4    | 0502-000153 | TR-POWER;2SC2344-D,NPN,1.2W,TO-220,-60               |        | ....2    |             | AA94-08574A ASSY PCB MISC-PWR-DEF;HCM4215W,P55A      | S.N.A   |
| ....4    | 6003-000335 | SCREW-TAPTITE;RH,+.2S,M3,L8,ZPC(YEL),SWR             | S.N.A  | ....3    | C432        | 2303-000002 PEF CAPACITOR;8.2nF,5%,400V,TP,19x18X7.7 |   |
| ....4    | AA62-00045A | HEAT SINK-PS;-T1.0,-DREAM,-,-,-,-                    | S.N.A  | ....3    | C438        | 2303-000002 PEF CAPACITOR;8.2nF,5%,400V,TP,19x18X7.7 |   |
| ....3    | RZ120       | 2008-001097 R-FUSIBLE(S);330HM,5%,1/2W,AC,BK,2.5X6.5 |        | ....3    | C491        | 2306-000322 C-FILM,MPPF;12nF,5%,1.6KV,TP,29x20.5x13  |   |
| ....3    | AA33-00017A | MAGNET CONVERGENCE;JH 92LT - 29G,-,29.1M             |        | ....3    | C814        | 2301-001041 C-FILM,PPF;15nF,5%,1.6KV,TP,29x14x21.5,2 |   |
| ....3    | 3301-001201 | CORE-FERRITE;AE,21x11x32mm,1500,280G                 |        | ....3    | C815        | 2401-000701 C-AL;2200uF,20%,250V,GP,-,35x70mm,1      |   |
| ....3    | 0202-000187 | SOLDER-WIRE FLUX;-RS60S,D1.2.63Sn/37Pb               | S.N.A  | ....3    | C816        | 2401-000701 C-AL;2200uF,20%,250V,GP,-,35x70mm,1      |   |
| ....3    | AA97-07230M | ASSY AUTO;COMMANDO                                   | S.N.A  | ....3    | C832        | 2306-000323 C-FILM,MPPF;2.2nF,5%,1.6KV,TP,28.5x15.5x |   |
| ....4    | CNZ102      | 3711-002642 CONNECTOR-HEADER;BOX,3P,1R,2.5mm,STRAIGH |        | ....3    | C850        | 2401-003076 C-AL;3300uF,20%,50V,WP,BK,18x35.5mm      |   |
| ....4    | CNZ103      | 3711-002642 CONNECTOR-HEADER;BOX,3P,1R,2.5mm,STRAIGH |        | ....3    | C852        | 2401-003076 C-AL;3300uF,20%,50V,WP,BK,18x35.5mm      |   |
| ....4    | CNZ104      | 3711-002642 CONNECTOR-HEADER;BOX,3P,1R,2.5mm,STRAIGH |        | ....3    | C856        | 2401-003076 C-AL;3300uF,20%,50V,WP,BK,18x35.5mm      |   |
| ....4    | CZ101       | 2401-002144 C-AL;47uF,20%,16V,GP,TP,5x11.5           |        | ....3    | C858        | 2401-000698 C-AL;2200uF,20%,16V,WT,TP,12.5x25.5      |   |
| ....4    | CZ102       | 2401-001157 C-AL;33uF,20%,160V,GP,TP,12.5x20.5       |        | ....3    | C863        | 2401-002251 C-AL;470uF,20%,200V,GP,BK,25x40mm,1      |   |
| ....4    | CZ103       | 2201-000516 C-CERAMIC,DISC;4.7nF,+100-0%,500V,Y5U,TP |        | ....3    | C864        | 2401-000787 C-AL;220uF,20%,160V,GP,TP,16x31.5mm      |   |
| ....4    | CZ104       | 2201-000193 C-CERAMIC,DISC;0.01nF,0.25pF,50V,NPO,TP  |        | ....3    | C870        | 2401-000142 C-AL;1000uF,20%,16V,WT,TP,10x20.5        |   |
| ....4    | CZ105       | 2201-000516 C-CERAMIC,DISC;4.7nF,+100-0%,500V,Y5U,TP |        | ....3    | CN801       | AA39-00180A LEAD CONNECTOR ASSY;14P,YBNH250-14,3515  |   |
| ....4    | CZ106       | 2201-000193 C-CERAMIC,DISC;0.01nF,0.25pF,50V,NPO,TP  |        | ....3    | CN802       | BP39-00014A LEAD CONNECTOR ASSY;P55A/HCM4215W,UL1007 |   |
| ....4    | CZ107       | 2401-001513 C-AL;47uF,20%,16V,WT,TP,5x11.5           |        | ....3    | CN803       | 3711-003043 CONNECTOR-HEADER;BOX,4P,1R,2.5mm,STRAIGH |   |
| ....4    | CZ108       | 2401-001220 C-AL;4.7uF,20%,160V,GP,TP,8x11.5,5       |        | △        | ....3       | CR430S   | 2301-001343 C-FILM,MPPF;3.9nF,5%,2kV,TP,29x9.5x16mm,  |
| ....4    | CZ109       | 2401-001220 C-AL;4.7uF,20%,160V,GP,TP,8x11.5,5       |        | △        | ....3       | CR431S   | 2301-001343 C-FILM,MPPF;3.9nF,5%,2kV,TP,29x9.5x16mm,  |
| ....4    | CZ110       | 2201-000604 C-CERAMIC,DISC;0.056nF,+100-0%,500V,SL,T |        | △        | ....3       | CR436S   | 2306-000235 C-FILM,MPPF;560nF,5%,400V,TP,26*22.5*14,  |
| ....4    | CZ111       | 2401-000480 C-AL;10uF,20%,50V,GP,TP,5x11.5           |        | △        | ....3       | CR471S   | 2301-001091 C-FILM,MPPF;470nF,5%,400V,TP,26x21.5x14.  |
| ....4    | CZ112       | 2401-000832 C-AL;220uF,20%,25V,GP,TP,8x11.5,5        |        | △        | ....3       | CR473S   | 2306-000322 C-FILM,MPPF;12nF,5%,1.6KV,TP,29x20.5x13,  |
| ....4    | DZ101       | 0402-000546 DIODE-RECTIFIER;TVR10G,400V,1.0A,DO-41,T |        | △        | ....3       | CR474S   | 2306-000326 C-FILM,MPPF;4.7nF,5%,1.6KV,TP,28.5x16x9mm |
| ....4    | DZ102       | 0401-000005 DIODE-SWITCHING;1N4148,100V,200mA,DO-35, |        | △        | ....3       | CR801S   | 2306-000112 C-FILM,MPPF;100nF,20%,250V,BK,-,15mm      |
| ....4    | DZ103       | 0402-000546 DIODE-RECTIFIER;TVR10G,400V,1.0A,DO-41,T |        | △        | ....3       | CX802S   | 2306-000112 C-FILM,MPPF;100nF,20%,250V,BK,-,15mm      |

| Loc. No. | Code No.    | Description ; Specification                           | Remark | Loc. No.     | Code No.    | Description ; Specification              | Remark |
|----------|-------------|---|--------|--------------|-------------|--|--------|
| △...3    | CY801S      | 2201-000987 C-CERAMIC,DISC;2.2nF,20%,400V,Y5U,TP,12.  |        | ...4         | 0502-001100 | TR-POWER;2SC4125,NPN,70W,TO-3PML,BK,8-   |        |
| △...3    | CY802S      | 2201-000987 C-CERAMIC,DISC;2.2nF,20%,400V,Y5U,TP,12.  |        | ...4         | 0205-000129 | GREASE-SILICON,SC102,JAPAN               | S.N.A  |
| △...3    | CY803S      | 2201-000963 C-CERAMIC,DISC;1nF,20%,400V,Y5U,TP,9.5x6  |        | ...3 R424    | 2008-000289 | R-FUSIBLE(S);10hm,5%,1W,AA,TP,3.9x10mm   |        |
| △...3    | CY804S      | 2201-000963 C-CERAMIC,DISC;1nF,20%,400V,Y5U,TP,9.5x6  |        | ...3 R425    | 2003-000417 | R-METAL OXIDE(S);1.2Kohm,5%,3W,AA,TP,6x1 |        |
| △...3    | CY811S      | 2201-000446 C-CERAMIC,DISC;3.3nF,20%,400V,Y5U,TP,15x  |        | ...3 R440    | 2008-000282 | R-FUSIBLE;0.47ohm,5%,1W,AA,TP,3.9x12mm   |        |
| △...3    | CY812S      | 2201-000446 C-CERAMIC,DISC;3.3nF,20%,400V,Y5U,TP,15x  |        | ...3 R831    | 2003-000512 | R-METAL OXIDE(S);15Kohm,5%,3W,AA,TP,6x16 |        |
| ...3     | D431        | 0402-000546 DIODE-RECTIFIER;TVR10G,400V,1.0A,DO-41,T  |        | ...3 R832    | 2003-000512 | R-METAL OXIDE(S);15Kohm,5%,3W,AA,TP,6x16 |        |
| ...3     | D464        | 0402-000236 DIODE-RECTIFIER;G1824,400V,5A,-,TP        |        | △...3 T431   | AA26-50001U | TRANS-HORIZ.DRIVE;-,-,28mH,-,-,105uH,-   |        |
| △...3    | D811S       | AA96-00276A ASSY H/S;- ,BRIDGE,AA62-00052A,RBV606,WAS | S.N.A  | △...3 T432   | AA26-00053A | TRANS;-,-,1.2mH,-,-,-,-,-,31.5KHz,-,-    |        |
| ...4     | AA62-00052A | HEAT SINK-PS;-,-,SILVER,HOLE 18.5mm, 2                | S.N.A  | △...3 T444S  | AA26-00100A | TRANS FBT;FFA97513L,CT29A7DR,0.3mH,-,-,- |        |
| ...4     | AA60-30003A | WASHER;-,-,T1.5,-,SBHG,-,1,-                          | S.N.A  | △...3 T461   | AA26-50001V | TRANS-HORIZ.DRIVE;-,-,6.0mH,-,-,113uH,-  |        |
| ...4     | 6003-000335 | SCREW-TAPTITE;RH,+2S,M3,L8,ZPC(YEL),SWR               | S.N.A  | △...3 T481   | AA26-00091A | TRANS-HV-STORAGE;4mH,-,14P830uH,180V,10  |        |
| ...4     | 0402-000549 | DIODE-BRIDGE;RBV606,600V,6A,-,BK                      |        | △...3 T801S  | BP26-00002A | TRANS SWITCHING;EER5345,P55A,160V-280V,P |        |
| ...4     | 0205-000129 | GREASE-SILICON;SC102,JAPAN                            | S.N.A  | △...3 TS801S | BP26-00001A | TRANS-POWER S/W (DPMS);19B012,P55A,HCM42 |        |
| △...3    | D831        | 0402-000250 DIODE-RECTIFIER;RG4C,1000V,1A,-           |        | △...3 VX801S | 1405-000187 | VARIABLE;1250A,12.5x7mm,TP               |        |
| △...3    | D855        | AA96-00243E ASSY H/S;- ,SOUND,AA62-00045A,FMG-626S    | S.N.A  | ...3         | 0202-000187 | SOLDER-WIRE FLUX;- ,RS60S,D1.2,63Sn/37Pb | S.N.A  |
| △...3    | D856        | AA96-00243E ASSY H/S;- ,SOUND,AA62-00045A,FMG-626S    | S.N.A  | ...3         | 3301-001201 | CORE-FERRITE;AE,21x11x32mm,1500,280G     |        |
| ...4     | 0205-000129 | GREASE-SILICON;SC102,JAPAN                            | S.N.A  | ...3         | BP39-00017A | LEAD CONNECTOR;P55A/HCM4215W,UL1617#22,U |        |
| ...4     | 0402-000231 | DIODE-RECTIFIER;FMG-626S,600V,4A,TO-220F              |        | ...4         | 3301-001201 | CORE-FERRITE;AE,21x11x32mm,1500,280G     |        |
| ...4     | 6003-000335 | SCREW-TAPTITE;RH,+2S,M3,L8,ZPC(YEL),SWR               | S.N.A  | ...3         | AA97-07506Z | ASSY AUTO-PWR DEF;HCM4215W               | S.N.A  |
| ...4     | AA62-00045A | HEAT SINK-PS;- ,T1.0,-,-,DREAM,-,-,-,-                | S.N.A  | ...4 C301    | 2305-000427 | C-FILM,MPEF;47nF,5%,100V,TP,7.5x12.5x3.5 |        |
| ...3     | DZS801      | 0406-001007 DIODE-TVS;P6KE180A,171/180/189V,600W,CAS  |        | ...4 C302    | 2201-000292 | C-CERAMIC,DISC;1nF,10%,50V,Y5P,TP,5x3.5  |        |
| △...3    | FP801S      | 3601-000300 FUSE-CARTRIDGE;250V,6.3A,SLOW-BLOW,GLASS  |        | ...4 C303    | 2305-000427 | C-FILM,MPEF;47nF,5%,100V,TP,7.5x12.5x3.5 |        |
| ...3     | GT01        | AA60-40012D PIN-GT,ASSY;4P,T1.6,6-12.5-14MM,NYLON66   | S.N.A  | ...4 C304    | 2201-000292 | C-CERAMIC,DISC;1nF,10%,50V,Y5P,TP,5x3.5  |        |
| ...3     | IC301       | AA96-00623A ASSY H/S;- ,POWER,AA62-00056A,LA7845      | S.N.A  | ...4 C307    | 2401-000365 | C-AL;100uF,20%,50V,WT,TP,10x12.5mm,      |        |
| ...4     | 0205-000129 | GREASE-SILICON;SC102,JAPAN                            | S.N.A  | ...4 C308    | 2401-000365 | C-AL;100uF,20%,50V,WT,TP,10x12.5mm,      |        |
| ...4     | 1204-000517 | IC-VERTICAL DEF;LA7845,SIP,7P,-,PLASTIC               |        | ...4 C309    | 2305-000285 | C-FILM,MPEF;220nF,5%,100V,TP,10.5X5.5X15 |        |
| ...4     | 6003-000334 | SCREW-TAPTITE;RH,+2S,M3,L6,ZPC(YEL),SWR               | S.N.A  | ...4 C311    | 2305-000149 | C-FILM,MPEF;100nF,5%,100V,TP,12x12.5x6.5 |        |
| ...4     | AA62-00056A | HEAT SINK-PS;- ,T1.0,-,-,41*35*70,D2,-,-              | S.N.A  | ...4 C405    | 2201-000558 | C-CERAMIC,DISC;0.47nF,10%,50V,Y5P,TP,5x3 |        |
| △...3    | IC421       | AA96-00475B ASSY H/S;SILICON-OIL,FMLG-12S(4),AA62-00  | S.N.A  | ...4 C406    | 2201-000370 | C-CERAMIC,DISC;0.22nF,10%,50V,Y5P,TP,4x3 |        |
| ...4     | AA62-00066B | HEAT SINK;D2,D3,AL,T1.0,89,70,-,AA62-00               | S.N.A  | ...4 C412    | 2301-000383 | C-FILM,PEF;10nF,5%,50V,TP,6x7x3.2mm,5mm  |        |
| ...4     | 6003-000334 | SCREW-TAPTITE;RH,+2S,M3,L6,ZPC(YEL),SWR               | S.N.A  | ...4 C413    | 2401-000360 | C-AL;100uF,20%,50V,GP,TP,8x11.5,5        |        |
| ...4     | 1203-000165 | IC-POSILADJUST REG.-78R12,TO-220,4P,-,PL              |        | ...4 C426    | 2401-000302 | C-AL;100uF,20%,50V,GP,TP,6.3x11.5        |        |
| ...4     | 0402-000233 | DIODE-RECTIFIER;FML-G12S,200V,5A,-,-                  |        | ...4 C427    | 2401-002300 | C-AL;47uF,20%,50V,GP,TP,6.3x11.5         |        |
| ...4     | 0205-000129 | GREASE-SILICON;SC102,JAPAN                            | S.N.A  | ...4 C428    | 2306-000122 | C-FILM,MPPF;100nF,5%,50V,TP,7.3x4.0x5.0m |        |
| △...3    | IC430       | 1203-000162 IC-POSILADJUST REG.;317,TO-220,3P,-,PLAS  |        | ...4 C429    | 2305-000704 | C-FILM,MPPF;100nF,5%,250V,TP,13x20mm,5m  |        |
| △...3    | IC431       | 1201-000191 IC-OP AMP;4558,DIP,8P,300MIL,DUAL,20V/mV  |        | ...4 C437    | 2401-003114 | C-AL;4.7uF,20%,250V,WT,TP,10x16,5        |        |
| △...3    | IC471       | 1203-000610 IC-PWM CONTROLLER;494,DIP,16P,300MIL,PLA  |        | ...4 C445    | 2401-001622 | C-AL;6.8uF,20%,50V,TP,TP,16x25mm,7       |        |
| △...3    | IC831S      | AA96-00275J ASSY H/S;SCREW,SILICON-OIL,AA62-00051A,S  | S.N.A  | ...4 C449    | 2201-000406 | C-CERAMIC,DISC;0.27nF,10%,2kV,Y5P,TP,6.3 |        |
| ...4     | CIS         | 0205-000129 GREASE-SILICON;SC102,JAPAN                | S.N.A  | ...4 C450    | 2401-001486 | C-AL;47uF,20%,160V,HR,TP,13x20mm,5m      |        |
| ...4     | CIS         | 6003-000333 SCREW-TAPTITE;RH,+2S,M3,L10,ZPC(YEL),SW   | S.N.A  | ...4 C451    | 2401-000262 | C-AL;100uF,20%,160V,HR,TP,16x25,7.5      |        |
| ...4     | CIS         | AA13-00105A IC HYBRID;STR-X6456,7-20TO+125,DIP,21A,   |        | ...4 C452    | 2201-000132 | C-CERAMIC,DISC;0.1nF,10%,500V,Y5P,TP,6.5 |        |
| ...4     | CIS         | AA62-00051A HEAT SINK-PS;-,-,SILVER,HOLE 31mm,ALL     | S.N.A  | ...4 C453    | 2401-002288 | C-AL;470uF,20%,50V,WT,TP,10x20,5         |        |
| △...3    | IC851       | 1203-001400 IC-POWER PRESCALER;SE110N,TO-220(SIP),3P  |        | ...4 C454    | 2401-001428 | C-AL;470uF,20%,50V,GP,TP,10x20,5         |        |
| ...3     | ICS801      | 1203-002177 IC-PWM CONTROLLER;VIPER12ADIP,DIP,8P,300  |        | ...4 C455    | 2201-000132 | C-CERAMIC,DISC;0.1nF,10%,500V,Y5P,TP,6.5 |        |
| ...3     | ICS802      | 1203-001006 IC-VOLTAGE REGULATOR;78R05,TO-220F,4P,-   |        | ...4 C456    | 2401-001527 | C-AL;47uF,20%,250V,HR,TP,13x25mm,5m      |        |
| ...3     | L432        | AA27-00095A COIL HORIZ. WIDTH;- ,600uH,YL9N 15x27.5 C |        | ...4 C457    | 2201-000132 | C-CERAMIC,DISC;0.1nF,10%,500V,Y5P,TP,6.5 |        |
| ...3     | L862        | AA27-10001C COIL-CHOKE;- ,100uH,K,-,5.0A,ST,700UH-KJR |        | ...4 C458    | 2401-002288 | C-AL;470uF,20%,25V,WT,TP,10x20,5         |        |
| ...3     | L863        | AA27-10001C COIL-CHOKE;- ,100uH,K,-,5.0A,ST,700UH-KJR |        | ...4 C459    | 2201-000132 | C-CERAMIC,DISC;0.1nF,10%,500V,Y5P,TP,6.5 |        |
| ...3     | L864        | AA27-10002L COIL-CHOKE;- ,24uH,K,-,2A,-,24UH-K,10x10m |        | ...4 C460    | 2303-000331 | C-FILM,PPF;4.7nF,5%,630V,TP,19.5x12x7.7  |        |
| △...3    | LR401S      | AA27-30003M COIL-LINEARLITY;- ,5uH,OWA14x15,USRC0.1x6 |        | ...4 C466    | 2401-002619 | C-AL;47uF,20%,25V,GP,TP,5x11,5           |        |
| ...3     | LX801S      | AA29-30002L FILTER-LINE NOISE;- ,10mHMIN,5A,AC90-260V |        | ...4 C467    | 2401-000360 | C-AL;100uF,20%,50V,GP,TP,8x11.5,5        |        |
| △...3    | LX802S      | AA29-30002M FILTER-LINE NOISE;- ,1mHMIN,5A,AC90-260V  |        | ...4 C468    | 2201-000119 | C-CERAMIC,DISC;100nF,+80-20%,50V,Y5V,TP, |        |
| △...3    | LX803S      | AA29-30002M FILTER-LINE NOISE;- ,1mHMIN,5A,AC90-260V  |        | ...4 C469    | 2201-000180 | C-CERAMIC,DISC;10nF,10%,50V,Y5V,TP,7x3,5 |        |
| △...3    | LX804S      | AA29-30002M FILTER-LINE NOISE;- ,1mHMIN,5A,AC90-260V  |        | ...4 C472    | 2401-000262 | C-AL;100uF,20%,160V,HR,TP,16x25,7.5      |        |
| △...3    | NT801S      | 1404-001195 THERMISTOR-NTC;5.1ohm,15%,2900,27mW/C,BK  |        | ...4 C476    | 2401-001989 | C-AL;4.7uF,20%,50V,GP,TP,5x11,5          |        |
| △...3    | PC801S      | 0604-001032 PHOTO-COUPLER;TR,170-260%,300mW,DIP-4,ST  |        | ...4 C477    | 2301-000213 | C-FILM,PEF;220nF,5%,250V,TP,21.5x11,7,5  |        |
| △...3    | PC811S      | 0604-001032 PHOTO-COUPLER;TR,170-260%,300mW,DIP-4,ST  |        | ...4 C478    | 2301-000020 | C-FILM,PEF;27nF,5%,100V,TP,7.3x4x12.5mm, |        |
| ...3     | Q422        | 0505-000156 FET-SILICON;IRF620,N,200V,5A,0.8ohm,50W,  |        | ...4 C479    | 2301-000200 | C-FILM,PEF;2.2nF,5%,200V,TP,11.0x6.0x9.0 |        |
| ...3     | Q423        | 0502-000405 TR-POWER;- ,NPN,70V,TO-220,BK,10          |        | ...4 C480    | 2306-000122 | C-FILM,MPPF;100nF,5%,50V,TP,7.3x4.0x5.0m |        |
| ...3     | Q431        | BH99-00033H ASSY HEAT/SINK;BH62-00038A,SPRING,2SC544  | S.N.A  | ...4 C481    | 2401-002235 | C-AL;10uF,20%,16V,GP,TP,5x11mm,5mm       |        |
| ...4     | CIS         | 0502-001230 TR-POWER;FJL6920YDTU,N,200000MW,TO-264 F  |        | ...4 C483    | 2401-000660 | C-AL;2.2uF,20%,50V,GP,TP,5x11,5          |        |
| ...4     | CIS         | 0205-001027 OIL-SILICON;G746,-,-                      | S.N.A  | ...4 C484    | 2201-000132 | C-CERAMIC,DISC;0.1nF,10%,500V,Y5P,TP,6.5 |        |
| ...4     | CIS         | BH73-00028A SILICON/RUBBER-HS;CDT ALL,SILICON,26*33*  | S.N.A  | ...4 C487    | 2305-000178 | C-FILM,MPEF;10nF,5%,100V,TP,-,5mm        |        |
| ...4     | CIS         | BH62-00038A HEAT SINK-FBT;TS17JS,A1050S,T2.0,-,-,-,-  | S.N.A  | ...4 C488    | 2401-002144 | C-AL;47uF,20%,16V,GP,TP,5x11,5           |        |
| ...4     | CIS         | BH61-70003A SPRING ETC;CVT4857,STS304-W1/2H,W3,8,-,L  | S.N.A  | ...4 C489    | 2401-001840 | C-AL;100uF,20%,16V,GP,TP,6.3x11,5        |        |
| ...4     | CIS         | 0402-001296 DIODE-RECTIFIER;FMP-3FU,1.5KV,5A,TO-3PF,  |        | ...4 C490    | 2201-000119 | C-CERAMIC,DISC;100nF,+80-20%,50V,Y5V,TP, |        |
| ...3     | Q433        | AA96-00243H ASSY H/S;- ,POWER,AA62-00045A,KSD73Y,C17A | S.N.A  | ...4 C492    | 2401-001026 | C-AL;3.3uF,20%,50V,GP,TP,5X11,5          |        |
| ...4     | 0205-000129 | GREASE-SILICON;SC102,JAPAN                            | S.N.A  | ...4 C811    | 2201-000332 | C-CERAMIC,DISC;2.2nF,20%,250V,Y5U,TP,9x4 |        |
| ...4     | 0502-000298 | TR-POWER;KSD73,NPN,30000mW,TO-220,TP,120              |        | ...4 C812    | 2201-000332 | C-CERAMIC,DISC;2.2nF,20%,250V,Y5U,TP,9x4 |        |
| ...4     | 6003-000335 | SCREW-TAPTITE;RH,+2S,M3,L8,ZPC(YEL),SWR               | S.N.A  | ...4 C813    | 2201-000332 | C-CERAMIC,DISC;2.2nF,20%,250V,Y5U,TP,9x4 |        |
| ...4     | AA62-00045A | HEAT SINK-PS;- ,T1.0,-,-,DREAM,-,-,-,-                | S.N.A  | ...4 C831    | 2301-001216 | C-FILM,PPF;47nF,5%,630V,TP,20x14.5x22,7  |        |
| ...3     | Q472        | 0505-000156 FET-SILICON;IRF620,N,200V,5A,0.8ohm,50W,  |        | ...4 C833    | 2201-000292 | C-CERAMIC,DISC;1nF,10%,50V,Y5P,TP,5x3.5, |        |
| ...3     | Q473        | BP96-00006A ASSY HEAT SINK P;BP62-00001A,SCREW,2SC41  | S.N.A  | ...4 C834    | 2401-001625 | C-AL;6.8uF,20%,50V,GP,TP,5x11,5          |        |
| ...4     | BP62-00001A | HEAT SINK;COMMANDO,A1050P,T2.0,W62.0,H50              | S.N.A  | ...4 C835    | 2401-002144 | C-AL;47uF,20%,16V,GP,TP,5x11,5           |        |
| ...4     | 6003-000335 | SCREW-TAPTITE;RH,+2S,M3,L8,ZPC(YEL),SWR               | S.N.A  | ...4 C837    | 2201-000138 | C-CERAMIC,DISC;100nF,10%,50V,Y5P,TP,4.0X |        |
| ...4     | 0505-001202 | FET-SILICON;IRFS640A,N,200V,9.8A,0.18ohm              |        | ...4 C838    | 2305-000412 | C-FILM,MPEF;470nF,5%,63V,TP,-,5mm        |        |

Electrical Parts List

| Loc. No. | Code No. | Description ; Specification | Remark                                   | Loc. No. | Code No. | Description ; Specification | Remark                                   |       |
|----------|----------|-----------------------------|--|----------|----------|-----------------------------|--|-------|
| ....     | C849     | 2401-002216                 | C-AL;2200uF,20%,35V,GP,TP,16x25,7.5      | ....     | DZS804   | 0403-001330                 | DIODE-ZENER;MTZJ30A,26.99-28.39V,500mW,D |       |
| ....     | C851     | 2201-000551                 | C-CERAMIC,DISC;0.47nF,10%,1KV,Y5P,TP,6.3 | ....     | EL01     | AA60-40011B                 | EYELET;ID2.2,0D3.2,-,BSP,-               | S.N.A |
| ....     | C853     | 2201-000551                 | C-CERAMIC,DISC;0.47nF,10%,1KV,Y5P,TP,6.3 | ....     | EL02     | AA60-40011B                 | EYELET;ID2.2,0D3.2,-,BSP,-               | S.N.A |
| ....     | C854     | 2401-002216                 | C-AL;2200uF,20%,35V,GP,TP,16x25,7.5      | ....     | EL03     | AA60-40011B                 | EYELET;ID2.2,0D3.2,-,BSP,-               | S.N.A |
| ....     | C855     | 2201-000551                 | C-CERAMIC,DISC;0.47nF,10%,1KV,Y5P,TP,6.3 | ....     | EL04     | AA60-40011B                 | EYELET;ID2.2,0D3.2,-,BSP,-               | S.N.A |
| ....     | C857     | 2201-000551                 | C-CERAMIC,DISC;0.47nF,10%,1KV,Y5P,TP,6.3 | ....     | EL05     | AA60-40011B                 | EYELET;ID2.2,0D3.2,-,BSP,-               | S.N.A |
| ....     | C859     | 2201-000551                 | C-CERAMIC,DISC;0.47nF,10%,1KV,Y5P,TP,6.3 | ....     | EL06     | AA60-40011B                 | EYELET;ID2.2,0D3.2,-,BSP,-               | S.N.A |
| ....     | C860     | 2401-000703                 | C-AL;2200uF,20%,25V,GP,-,12.5x25mm,      | ....     | EL07     | AA60-40011B                 | EYELET;ID2.2,0D3.2,-,BSP,-               | S.N.A |
| ....     | C861     | 2401-000603                 | C-AL;1uF,20%,50V,GP,TP,5x11,5            | ....     | EL08     | AA60-40011B                 | EYELET;ID2.2,0D3.2,-,BSP,-               | S.N.A |
| ....     | C862     | 2201-000551                 | C-CERAMIC,DISC;0.47nF,10%,1KV,Y5P,TP,6.3 | ....     | EL10     | AA60-40011B                 | EYELET;ID2.2,0D3.2,-,BSP,-               | S.N.A |
| ....     | C865     | 2305-000427                 | C-FILM,MPEF;47nF,5%,100V,TP,7.5x12.5x3.5 | ....     | EL11     | AA60-40011B                 | EYELET;ID2.2,0D3.2,-,BSP,-               | S.N.A |
| ....     | C866     | 2401-001397                 | C-AL;470uF,20%,25V,GP,TP,10x16,5         | ....     | EL12     | AA60-40011B                 | EYELET;ID2.2,0D3.2,-,BSP,-               | S.N.A |
| ....     | C867     | 2201-000180                 | C-CERAMIC,DISC;10nF,10%,50V,Y5V,TP,7x3,5 | ....     | EL13     | AA60-40011B                 | EYELET;ID2.2,0D3.2,-,BSP,-               | S.N.A |
| ....     | C868     | 2401-000302                 | C-AL;100uF,20%,25V,GP,TP,6.3x11,5        | ....     | EL14     | AA60-40011B                 | EYELET;ID2.2,0D3.2,-,BSP,-               | S.N.A |
| ....     | C869     | 2401-000164                 | C-AL;1000uF,20%,25V,WT,TP,12.5x20,5      | ....     | EL15     | AA60-40011B                 | EYELET;ID2.2,0D3.2,-,BSP,-               | S.N.A |
| ....     | C871     | 2305-000289                 | C-FILM,MPEF;220nF,5%,63V,TP,-,5mm        | ....     | EL16     | AA60-40011B                 | EYELET;ID2.2,0D3.2,-,BSP,-               | S.N.A |
| ....     | CN401    | 3711-002645                 | CONNECTOR-HEADER;BOX,6P,1R,2.5mm,STRAIGH | ....     | EY01     | AA60-40011A                 | EYELET;ID2.0,0D2.8,-,BST,-               | S.N.A |
| △        | CR401S   | 2401-001026                 | C-AL;3.3uF,20%,50V,GP,TP,5X11,5          | ....     | EY02     | AA60-40011A                 | EYELET;ID2.0,0D2.8,-,BST,-               | S.N.A |
| △        | CR402S   | 2201-000146                 | C-CERAMIC,DISC;0.1nF,5%,50V,SL,TP,5x3,5  | ....     | EY03     | AA60-40011A                 | EYELET;ID2.0,0D2.8,-,BST,-               | S.N.A |
| △        | CR403S   | 2201-000146                 | C-CERAMIC,DISC;0.1nF,5%,50V,SL,TP,5x3,5  | ....     | EY04     | AA60-40011A                 | EYELET;ID2.0,0D2.8,-,BST,-               | S.N.A |
| ....     | CS801    | 2301-000356                 | C-FILM,PEF;47nF,5%,50V,TP,7.5x4.0x6.5,5m | ....     | EY05     | AA60-40011A                 | EYELET;ID2.0,0D2.8,-,BST,-               | S.N.A |
| ....     | CS802    | 2401-000480                 | C-AL;10uF,20%,50V,GP,TP,5x11,5           | ....     | EY06     | AA60-40011A                 | EYELET;ID2.0,0D2.8,-,BST,-               | S.N.A |
| ....     | CS803    | 2401-001192                 | C-AL;33uF,20%,50V,GP,TP,6.3x11,5         | ....     | EY07     | AA60-40011A                 | EYELET;ID2.0,0D2.8,-,BST,-               | S.N.A |
| ....     | CS804    | 2201-000119                 | C-CERAMIC,DISC;100nF,+80-20%,50V,Y5V,TP, | ....     | EY08     | AA60-40011A                 | EYELET;ID2.0,0D2.8,-,BST,-               | S.N.A |
| ....     | CS807    | 2401-001655                 | C-AL;680uF,20%,25V,GP,TP,10x20,5         | ....     | EY09     | AA60-40011A                 | EYELET;ID2.0,0D2.8,-,BST,-               | S.N.A |
| ....     | CS808    | 2401-002463                 | C-AL;470uF,20%,16V,GP,TP,8x11,5,5        | ....     | EY10     | AA60-40011A                 | EYELET;ID2.0,0D2.8,-,BST,-               | S.N.A |
| ....     | CS809    | 2201-000119                 | C-CERAMIC,DISC;100nF,+80-20%,50V,Y5V,TP, | ....     | EY100    | AA60-40011A                 | EYELET;ID2.0,0D2.8,-,BST,-               | S.N.A |
| ....     | D301     | 0401-000005                 | DIODE-SWITCHING;1N4148,100V,200mA,DO-35, | ....     | EY101    | AA60-40011A                 | EYELET;ID2.0,0D2.8,-,BST,-               | S.N.A |
| ....     | D302     | 0402-000546                 | DIODE-RECTIFIER;TVR10G,400V,1.0A,DO-41,T | ....     | EY102    | AA60-40011A                 | EYELET;ID2.0,0D2.8,-,BST,-               | S.N.A |
| ....     | D384     | 0402-000132                 | DIODE-RECTIFIER;1N4004,400V,1A,DO-41,TP  | ....     | EY103    | AA60-40011A                 | EYELET;ID2.0,0D2.8,-,BST,-               | S.N.A |
| ....     | D385     | 0401-000005                 | DIODE-SWITCHING;1N4148,100V,200mA,DO-35, | ....     | EY104    | AA60-40011A                 | EYELET;ID2.0,0D2.8,-,BST,-               | S.N.A |
| ....     | D433     | 0402-000537                 | DIODE-RECTIFIER;RH1A,600V,0.6A,DO-204AC  | ....     | EY105    | AA60-40011A                 | EYELET;ID2.0,0D2.8,-,BST,-               | S.N.A |
| ....     | D435     | 0402-000132                 | DIODE-RECTIFIER;1N4004,400V,1A,DO-41,TP  | ....     | EY106    | AA60-40011A                 | EYELET;ID2.0,0D2.8,-,BST,-               | S.N.A |
| ....     | D436     | 0401-000005                 | DIODE-SWITCHING;1N4148,100V,200mA,DO-35, | ....     | EY107    | AA60-40011A                 | EYELET;ID2.0,0D2.8,-,BST,-               | S.N.A |
| ....     | D440     | 0402-000534                 | DIODE-RECTIFIER;RG10V,400V,1.2A,DO-201,T | ....     | EY108    | AA60-40011A                 | EYELET;ID2.0,0D2.8,-,BST,-               | S.N.A |
| ....     | D441     | 0402-000534                 | DIODE-RECTIFIER;RG10V,400V,1.2A,DO-201,T | ....     | EY109    | AA60-40011A                 | EYELET;ID2.0,0D2.8,-,BST,-               | S.N.A |
| ....     | D442     | 0401-000005                 | DIODE-SWITCHING;1N4148,100V,200mA,DO-35, | ....     | EY11     | AA60-40011A                 | EYELET;ID2.0,0D2.8,-,BST,-               | S.N.A |
| ....     | D443     | 0401-000005                 | DIODE-SWITCHING;1N4148,100V,200mA,DO-35, | ....     | EY111    | AA60-40011A                 | EYELET;ID2.0,0D2.8,-,BST,-               | S.N.A |
| ....     | D445     | 0402-000534                 | DIODE-RECTIFIER;RG10V,400V,1.2A,DO-201,T | ....     | EY113    | AA60-40011A                 | EYELET;ID2.0,0D2.8,-,BST,-               | S.N.A |
| ....     | D451     | 0402-000534                 | DIODE-RECTIFIER;RG10V,400V,1.2A,DO-201,T | ....     | EY114    | AA60-40011A                 | EYELET;ID2.0,0D2.8,-,BST,-               | S.N.A |
| ....     | D453     | 0402-001286                 | DIODE-RECTIFIER;RP1H,2000V,1A,-,TP       | ....     | EY115    | AA60-40011A                 | EYELET;ID2.0,0D2.8,-,BST,-               | S.N.A |
| ....     | D472     | 0402-000546                 | DIODE-RECTIFIER;TVR10G,400V,1.0A,DO-41,T | ....     | EY116    | AA60-40011A                 | EYELET;ID2.0,0D2.8,-,BST,-               | S.N.A |
| ....     | D474     | 0402-000546                 | DIODE-RECTIFIER;TVR10G,400V,1.0A,DO-41,T | ....     | EY117    | AA60-40011A                 | EYELET;ID2.0,0D2.8,-,BST,-               | S.N.A |
| ....     | D477     | 0401-000005                 | DIODE-SWITCHING;1N4148,100V,200mA,DO-35, | ....     | EY118    | AA60-40011A                 | EYELET;ID2.0,0D2.8,-,BST,-               | S.N.A |
| ....     | D478     | 0401-000005                 | DIODE-SWITCHING;1N4148,100V,200mA,DO-35, | ....     | EY119    | AA60-40011A                 | EYELET;ID2.0,0D2.8,-,BST,-               | S.N.A |
| ....     | D479     | 0401-000005                 | DIODE-SWITCHING;1N4148,100V,200mA,DO-35, | ....     | EY12     | AA60-40011A                 | EYELET;ID2.0,0D2.8,-,BST,-               | S.N.A |
| ....     | D480     | 0402-000132                 | DIODE-RECTIFIER;1N4004,400V,1A,DO-41,TP  | ....     | EY120    | AA60-40011A                 | EYELET;ID2.0,0D2.8,-,BST,-               | S.N.A |
| ....     | D484     | 0402-000132                 | DIODE-RECTIFIER;1N4004,400V,1A,DO-41,TP  | ....     | EY121    | AA60-40011A                 | EYELET;ID2.0,0D2.8,-,BST,-               | S.N.A |
| ....     | D501     | 0402-000132                 | DIODE-RECTIFIER;1N4004,400V,1A,DO-41,TP  | ....     | EY122    | AA60-40011A                 | EYELET;ID2.0,0D2.8,-,BST,-               | S.N.A |
| △        | D843     | 0402-000546                 | DIODE-RECTIFIER;TVR10G,400V,1.0A,DO-41,T | ....     | EY123    | AA60-40011A                 | EYELET;ID2.0,0D2.8,-,BST,-               | S.N.A |
| △        | D857     | 0402-000132                 | DIODE-RECTIFIER;1N4004,400V,1A,DO-41,TP  | ....     | EY124    | AA60-40011A                 | EYELET;ID2.0,0D2.8,-,BST,-               | S.N.A |
| △        | DR401S   | 0401-000005                 | DIODE-SWITCHING;1N4148,100V,200mA,DO-35, | ....     | EY125    | AA60-40011A                 | EYELET;ID2.0,0D2.8,-,BST,-               | S.N.A |
| △        | DR402S   | 0401-000005                 | DIODE-SWITCHING;1N4148,100V,200mA,DO-35, | ....     | EY126    | AA60-40011A                 | EYELET;ID2.0,0D2.8,-,BST,-               | S.N.A |
| △        | DR404S   | 0403-001325                 | DIODE-ZENER;MTZJ15C,14.35-15.09V,500mW,D | ....     | EY127    | AA60-40011A                 | EYELET;ID2.0,0D2.8,-,BST,-               | S.N.A |
| ....     | DS801    | 0402-000254                 | DIODE-RECTIFIER;RGP10J,600V,1A,DO-41,TP  | ....     | EY128    | AA60-40011A                 | EYELET;ID2.0,0D2.8,-,BST,-               | S.N.A |
| ....     | DS802    | 0401-000006                 | DIODE-SWITCHING;BAV21,250V,250mA,DO-35,T | ....     | EY129    | AA60-40011A                 | EYELET;ID2.0,0D2.8,-,BST,-               | S.N.A |
| ....     | DS804    | 0401-000006                 | DIODE-SWITCHING;BAV21,250V,250mA,DO-35,T | ....     | EY13     | AA60-40011A                 | EYELET;ID2.0,0D2.8,-,BST,-               | S.N.A |
| ....     | DS805    | 0404-001056                 | DIODE-SCHOTTKY;RK16,60V,1.5A,DO-204AC,TP | ....     | EY130    | AA60-40011A                 | EYELET;ID2.0,0D2.8,-,BST,-               | S.N.A |
| ....     | DZ301    | 0403-001327                 | DIODE-ZENER;MTZJ18A,16.22-17.06V,500mW,D | ....     | EY131    | AA60-40011A                 | EYELET;ID2.0,0D2.8,-,BST,-               | S.N.A |
| ....     | DZ304    | 0403-001327                 | DIODE-ZENER;MTZJ18A,16.22-17.06V,500mW,D | ....     | EY132    | AA60-40011A                 | EYELET;ID2.0,0D2.8,-,BST,-               | S.N.A |
| ....     | DZ305    | 0403-001329                 | DIODE-ZENER;MTZJ24B,22.61-23.77V,500mW,D | ....     | EY133    | AA60-40011A                 | EYELET;ID2.0,0D2.8,-,BST,-               | S.N.A |
| ....     | DZ306    | 0403-001330                 | DIODE-ZENER;MTZJ30A,26.99-28.39V,500mW,D | ....     | EY134    | AA60-40011A                 | EYELET;ID2.0,0D2.8,-,BST,-               | S.N.A |
| ....     | DZ307    | 0403-001329                 | DIODE-ZENER;MTZJ24B,22.61-23.77V,500mW,D | ....     | EY135    | AA60-40011A                 | EYELET;ID2.0,0D2.8,-,BST,-               | S.N.A |
| ....     | DZ386    | 0403-001316                 | DIODE-ZENER;MTZJ3.0A,2.85-3.07V,500mW,DO | ....     | EY136    | AA60-40011A                 | EYELET;ID2.0,0D2.8,-,BST,-               | S.N.A |
| ....     | DZ395    | 0403-001319                 | DIODE-ZENER;MTZJ4.7C,4.68-4.93V,500mW,DO | ....     | EY137    | AA60-40011A                 | EYELET;ID2.0,0D2.8,-,BST,-               | S.N.A |
| ....     | DZ400    | 0403-001325                 | DIODE-ZENER;MTZJ15C,14.35-15.09V,500mW,D | ....     | EY138    | AA60-40011A                 | EYELET;ID2.0,0D2.8,-,BST,-               | S.N.A |
| ....     | DZ413    | 0403-001319                 | DIODE-ZENER;MTZJ4.7C,4.68-4.93V,500mW,DO | ....     | EY139    | AA60-40011A                 | EYELET;ID2.0,0D2.8,-,BST,-               | S.N.A |
| ....     | DZ473    | 0403-000720                 | DIODE-ZENER;MTZJ9.1B,9.1V,8.57-9.01V,500 | ....     | EY14     | AA60-40011A                 | EYELET;ID2.0,0D2.8,-,BST,-               | S.N.A |
| ....     | DZ474    | 0403-000734                 | DIODE-ZENER;TZP15B,15V,14.7-16.5V,1W,DO  | ....     | EY140    | AA60-40011A                 | EYELET;ID2.0,0D2.8,-,BST,-               | S.N.A |
| ....     | DZ481    | 0403-001327                 | DIODE-ZENER;MTZJ18A,16.22-17.06V,500mW,D | ....     | EY141    | AA60-40011A                 | EYELET;ID2.0,0D2.8,-,BST,-               | S.N.A |
| △        | DZ482S   | 0403-000720                 | DIODE-ZENER;MTZJ9.1B,9.1V,8.57-9.01V,500 | ....     | EY142    | AA60-40011A                 | EYELET;ID2.0,0D2.8,-,BST,-               | S.N.A |
| ....     | DZ483    | 0403-000720                 | DIODE-ZENER;MTZJ9.1B,9.1V,8.57-9.01V,500 | ....     | EY147    | AA60-40011A                 | EYELET;ID2.0,0D2.8,-,BST,-               | S.N.A |
| ....     | DZ804    | 0403-001167                 | DIODE-ZENER;MTZJ30D,30V,29.02-30.51V,500 | ....     | EY148    | AA60-40011A                 | EYELET;ID2.0,0D2.8,-,BST,-               | S.N.A |
| ....     | DZ831    | 0403-000716                 | DIODE-ZENER;MTZJ4.7B,4.7V,4.55-4.8V,500m | ....     | EY149    | AA60-40011A                 | EYELET;ID2.0,0D2.8,-,BST,-               | S.N.A |
| ....     | DZ851    | 0403-001325                 | DIODE-ZENER;MTZJ15C,14.35-15.09V,500mW,D | ....     | EY15     | AA60-40011A                 | EYELET;ID2.0,0D2.8,-,BST,-               | S.N.A |
| ....     | DZS802   | 0403-000704                 | DIODE-ZENER;TZP7.5B,7.5V,7.5-8.4V,1W,DO- | ....     | EY150    | AA60-40011A                 | EYELET;ID2.0,0D2.8,-,BST,-               | S.N.A |
| ....     | DZS803   | 0403-001328                 | DIODE-ZENER;MTZJ22A,20.15-21.20V,500mW,D | ....     | EY151    | AA60-40011A                 | EYELET;ID2.0,0D2.8,-,BST,-               | S.N.A |

| Loc. No. | Code No. | Description ; Specification            | Remark | Loc. No. | Code No. | Description ; Specification                           | Remark |
|----------|----------|--|--------|----------|----------|---|--------|
| ...4     | EY152    | AA60-40011A EYELET;ID2.0,OD2.8,-,BST,- | S.N.A  | ...4     | EY91     | AA60-40011A EYELET;ID2.0,OD2.8,-,BST,-                | S.N.A  |
| ...4     | EY153    | AA60-40011A EYELET;ID2.0,OD2.8,-,BST,- | S.N.A  | ...4     | EY92     | AA60-40011A EYELET;ID2.0,OD2.8,-,BST,-                | S.N.A  |
| ...4     | EY154    | AA60-40011A EYELET;ID2.0,OD2.8,-,BST,- | S.N.A  | ...4     | EY93     | AA60-40011A EYELET;ID2.0,OD2.8,-,BST,-                | S.N.A  |
| ...4     | EY155    | AA60-40011A EYELET;ID2.0,OD2.8,-,BST,- | S.N.A  | ...4     | EY94     | AA60-40011A EYELET;ID2.0,OD2.8,-,BST,-                | S.N.A  |
| ...4     | EY16     | AA60-40011A EYELET;ID2.0,OD2.8,-,BST,- | S.N.A  | ...4     | EY95     | AA60-40011A EYELET;ID2.0,OD2.8,-,BST,-                | S.N.A  |
| ...4     | EY17     | AA60-40011A EYELET;ID2.0,OD2.8,-,BST,- | S.N.A  | ...4     | EY96     | AA60-40011A EYELET;ID2.0,OD2.8,-,BST,-                | S.N.A  |
| ...4     | EY18     | AA60-40011A EYELET;ID2.0,OD2.8,-,BST,- | S.N.A  | ...4     | EY97     | AA60-40011A EYELET;ID2.0,OD2.8,-,BST,-                | S.N.A  |
| ...4     | EY19     | AA60-40011A EYELET;ID2.0,OD2.8,-,BST,- | S.N.A  | ...4     | EY98     | AA60-40011A EYELET;ID2.0,OD2.8,-,BST,-                | S.N.A  |
| ...4     | EY20     | AA60-40011A EYELET;ID2.0,OD2.8,-,BST,- | S.N.A  | ...4     | EY99     | AA60-40011A EYELET;ID2.0,OD2.8,-,BST,-                | S.N.A  |
| ...4     | EY21     | AA60-40011A EYELET;ID2.0,OD2.8,-,BST,- | S.N.A  | ...4     | F801A    | 3602-000114 FUSE-HOLDER,-,30mohm                      |        |
| ...4     | EY22     | AA60-40011A EYELET;ID2.0,OD2.8,-,BST,- | S.N.A  | ...4     | F801B    | 3602-000114 FUSE-HOLDER,-,30mohm                      |        |
| ...4     | EY23     | AA60-40011A EYELET;ID2.0,OD2.8,-,BST,- | S.N.A  | ...4     | FD801S   | 3601-000120 FUSE-AXIAL LEAD;125V,2.5A,FAST-ACTING,GL  |        |
| ...4     | EY24     | AA60-40011A EYELET;ID2.0,OD2.8,-,BST,- | S.N.A  | △        | FD802S   | 3601-001228 FUSE-AXIAL LEAD;125V,10A,FAST-ACTING,EPO  |        |
| ...4     | EY25     | AA60-40011A EYELET;ID2.0,OD2.8,-,BST,- | S.N.A  | △        | FD805S   | 3601-001086 FUSE-AXIAL LEAD;125V,5A,FAST-ACTING,GLAS  |        |
| ...4     | EY26     | AA60-40011A EYELET;ID2.0,OD2.8,-,BST,- | S.N.A  | △        | FD854S   | 3601-001086 FUSE-AXIAL LEAD;125V,5A,FAST-ACTING,GLAS  |        |
| ...4     | EY27     | AA60-40011A EYELET;ID2.0,OD2.8,-,BST,- | S.N.A  | △        | FD855S   | 3601-001228 FUSE-AXIAL LEAD;125V,10A,FAST-ACTING,EPO  |        |
| ...4     | EY28     | AA60-40011A EYELET;ID2.0,OD2.8,-,BST,- | S.N.A  | △        | FD871S   | 3601-001086 FUSE-AXIAL LEAD;125V,5A,FAST-ACTING,GLAS  |        |
| ...4     | EY29     | AA60-40011A EYELET;ID2.0,OD2.8,-,BST,- | S.N.A  | ...4     | GT14     | AA60-40014A PIN-GT,ASSY;1P,-,AUTO                     | S.N.A  |
| ...4     | EY30     | AA60-40011A EYELET;ID2.0,OD2.8,-,BST,- | S.N.A  | ...4     | GT15     | AA60-40014A PIN-GT,ASSY;1P,-,AUTO                     | S.N.A  |
| ...4     | EY31     | AA60-40011A EYELET;ID2.0,OD2.8,-,BST,- | S.N.A  | ...4     | GT16     | AA60-40014A PIN-GT,ASSY;1P,-,AUTO                     | S.N.A  |
| ...4     | EY32     | AA60-40011A EYELET;ID2.0,OD2.8,-,BST,- | S.N.A  | ...4     | GT17     | AA60-40014A PIN-GT,ASSY;1P,-,AUTO                     | S.N.A  |
| ...4     | EY34     | AA60-40011A EYELET;ID2.0,OD2.8,-,BST,- | S.N.A  | ...4     | GT33     | AA60-40014A PIN-GT,ASSY;1P,-,AUTO                     | S.N.A  |
| ...4     | EY35     | AA60-40011A EYELET;ID2.0,OD2.8,-,BST,- | S.N.A  | ...4     | GT34     | AA60-40014A PIN-GT,ASSY;1P,-,AUTO                     | S.N.A  |
| ...4     | EY36     | AA60-40011A EYELET;ID2.0,OD2.8,-,BST,- | S.N.A  | ...4     | GT35     | AA60-40014A PIN-GT,ASSY;1P,-,AUTO                     | S.N.A  |
| ...4     | EY37     | AA60-40011A EYELET;ID2.0,OD2.8,-,BST,- | S.N.A  | ...4     | GT404    | AA60-40014A PIN-GT,ASSY;1P,-,AUTO                     | S.N.A  |
| ...4     | EY38     | AA60-40011A EYELET;ID2.0,OD2.8,-,BST,- | S.N.A  | ...4     | GT801    | AA60-40014A PIN-GT,ASSY;1P,-,AUTO                     | S.N.A  |
| ...4     | EY39     | AA60-40011B EYELET;ID2.2,OD3.2,-,BSP,- | S.N.A  | ...4     | GT802    | AA60-40014A PIN-GT,ASSY;1P,-,AUTO                     | S.N.A  |
| ...4     | EY40     | AA60-40011B EYELET;ID2.2,OD3.2,-,BSP,- | S.N.A  | ...4     | GT807    | AA60-40014A PIN-GT,ASSY;1P,-,AUTO                     | S.N.A  |
| ...4     | EY41     | AA60-40011B EYELET;ID2.2,OD3.2,-,BSP,- | S.N.A  | ...4     | GT810    | AA60-40014A PIN-GT,ASSY;1P,-,AUTO                     | S.N.A  |
| ...4     | EY42     | AA60-40011B EYELET;ID2.2,OD3.2,-,BSP,- | S.N.A  | ...4     | GT811    | AA60-40014A PIN-GT,ASSY;1P,-,AUTO                     | S.N.A  |
| ...4     | EY43     | AA60-40011A EYELET;ID2.0,OD2.8,-,BST,- | S.N.A  | △        | ICR01S   | 1203-001217 IC-POS.ADJUST REG.;431,TO-92,3P4.58MIL    |        |
| ...4     | EY44     | AA60-40011A EYELET;ID2.0,OD2.8,-,BST,- | S.N.A  | ...4     | L431     | 2701-000116 INDUCTOR-AXIAL;10uH,10%,4.2x9.8mm         |        |
| ...4     | EY45     | AA60-40011A EYELET;ID2.0,OD2.8,-,BST,- | S.N.A  | ...4     | L481     | 3301-000287 CORE-FERRITE BEAD;AA,3.5x1.0x6.0mm,1500,  |        |
| ...4     | EY46     | AA60-40011A EYELET;ID2.0,OD2.8,-,BST,- | S.N.A  | ...4     | L482     | 3301-000374 CORE-FERRITE BEAD;AA,3.5x1.0x9.0mm,-,-    |        |
| ...4     | EY47     | AA60-40011A EYELET;ID2.0,OD2.8,-,BST,- | S.N.A  | ...4     | L483     | 2901-000299 FILTER-EMI ON BOARD;-,6A,U/L/CSA,-,9x7.5, |        |
| ...4     | EY49     | AA60-40011A EYELET;ID2.0,OD2.8,-,BST,- | S.N.A  | ...4     | L492     | 3301-000287 CORE-FERRITE BEAD;AA,3.5x1.0x6.0mm,1500,  |        |
| ...4     | EY50     | AA60-40011A EYELET;ID2.0,OD2.8,-,BST,- | S.N.A  | ...4     | L493     | 3301-000287 CORE-FERRITE BEAD;AA,3.5x1.0x6.0mm,1500,  |        |
| ...4     | EY51     | AA60-40011B EYELET;ID2.2,OD3.2,-,BSP,- | S.N.A  | ...4     | L494     | 3301-000374 CORE-FERRITE BEAD;AA,3.5x1.0x9.0mm,-,-    |        |
| ...4     | EY52     | AA60-40011B EYELET;ID2.2,OD3.2,-,BSP,- | S.N.A  | ...4     | L495     | 3301-000287 CORE-FERRITE BEAD;AA,3.5x1.0x6.0mm,1500,  |        |
| ...4     | EY53     | AA60-40011B EYELET;ID2.2,OD3.2,-,BSP,- | S.N.A  | ...4     | L831     | 2901-000297 FILTER-EMI ON BOARD;-,3A,-,-,3.5x5,TP,-   |        |
| ...4     | EY54     | AA60-40011B EYELET;ID2.2,OD3.2,-,BSP,- | S.N.A  | ...4     | L832     | 2901-000297 FILTER-EMI ON BOARD;-,3A,-,-,3.5x5,TP,-   |        |
| ...4     | EY55     | AA60-40011B EYELET;ID2.2,OD3.2,-,BSP,- | S.N.A  | ...4     | L833     | 2901-000297 FILTER-EMI ON BOARD;-,3A,-,-,3.5x5,TP,-   |        |
| ...4     | EY56     | AA60-40011B EYELET;ID2.2,OD3.2,-,BSP,- | S.N.A  | ...4     | L834     | 2901-000297 FILTER-EMI ON BOARD;-,3A,-,-,3.5x5,TP,-   |        |
| ...4     | EY57     | AA60-40011B EYELET;ID2.2,OD3.2,-,BSP,- | S.N.A  | ...4     | L835     | 3301-000287 CORE-FERRITE BEAD;AA,3.5x1.0x6.0mm,1500,  |        |
| ...4     | EY58     | AA60-40011B EYELET;ID2.2,OD3.2,-,BSP,- | S.N.A  | ...4     | L836     | 3301-000287 CORE-FERRITE BEAD;AA,3.5x1.0x6.0mm,1500,  |        |
| ...4     | EY59     | AA60-40011B EYELET;ID2.2,OD3.2,-,BSP,- | S.N.A  | ...4     | L837     | 3301-000287 CORE-FERRITE BEAD;AA,3.5x1.0x6.0mm,1500,  |        |
| ...4     | EY60     | AA60-40011B EYELET;ID2.2,OD3.2,-,BSP,- | S.N.A  | ...4     | L851     | 3301-000287 CORE-FERRITE BEAD;AA,3.5x1.0x6.0mm,1500,  |        |
| ...4     | EY61     | AA60-40011B EYELET;ID2.2,OD3.2,-,BSP,- | S.N.A  | ...4     | L852     | 2901-000297 FILTER-EMI ON BOARD;-,3A,-,-,3.5x5,TP,-   |        |
| ...4     | EY62     | AA60-40011B EYELET;ID2.2,OD3.2,-,BSP,- | S.N.A  | ...4     | L853     | 2901-000297 FILTER-EMI ON BOARD;-,3A,-,-,3.5x5,TP,-   |        |
| ...4     | EY63     | AA60-40011B EYELET;ID2.2,OD3.2,-,BSP,- | S.N.A  | ...4     | L854     | 2901-000297 FILTER-EMI ON BOARD;-,3A,-,-,3.5x5,TP,-   |        |
| ...4     | EY64     | AA60-40011A EYELET;ID2.0,OD2.8,-,BST,- | S.N.A  | ...4     | L855     | 2901-000297 FILTER-EMI ON BOARD;-,3A,-,-,3.5x5,TP,-   |        |
| ...4     | EY65     | AA60-40011A EYELET;ID2.0,OD2.8,-,BST,- | S.N.A  | ...4     | L856     | 2901-000297 FILTER-EMI ON BOARD;-,3A,-,-,3.5x5,TP,-   |        |
| ...4     | EY66     | AA60-40011A EYELET;ID2.0,OD2.8,-,BST,- | S.N.A  | ...4     | L857     | 2901-000297 FILTER-EMI ON BOARD;-,3A,-,-,3.5x5,TP,-   |        |
| ...4     | EY67     | AA60-40011A EYELET;ID2.0,OD2.8,-,BST,- | S.N.A  | ...4     | Q301     | 0501-000389 TR-SMALL SIGNAL;KSC815,NPN,400mW,TO-92,T  |        |
| ...4     | EY68     | AA60-40011A EYELET;ID2.0,OD2.8,-,BST,- | S.N.A  | ...4     | Q381     | 0501-000389 TR-SMALL SIGNAL;KSC815,NPN,400mW,TO-92,T  |        |
| ...4     | EY69     | AA60-40011A EYELET;ID2.0,OD2.8,-,BST,- | S.N.A  | ...4     | Q382     | 0501-000389 TR-SMALL SIGNAL;KSC815,NPN,400mW,TO-92,T  |        |
| ...4     | EY70     | AA60-40011A EYELET;ID2.0,OD2.8,-,BST,- | S.N.A  | ...4     | Q401     | 0501-000389 TR-SMALL SIGNAL;KSC815,NPN,400mW,TO-92,T  |        |
| ...4     | EY71     | AA60-40011A EYELET;ID2.0,OD2.8,-,BST,- | S.N.A  | ...4     | Q402     | 0501-000389 TR-SMALL SIGNAL;KSC815,NPN,400mW,TO-92,T  |        |
| ...4     | EY72     | AA60-40011A EYELET;ID2.0,OD2.8,-,BST,- | S.N.A  | ...4     | Q421     | 0501-000389 TR-SMALL SIGNAL;KSC815,NPN,400mW,TO-92,T  |        |
| ...4     | EY73     | AA60-40011A EYELET;ID2.0,OD2.8,-,BST,- | S.N.A  | ...4     | Q432     | 0501-000283 R-SMALL SIGNAL;KSA539,PNP,400mW,TO-92,T   |        |
| ...4     | EY74     | AA60-40011A EYELET;ID2.0,OD2.8,-,BST,- | S.N.A  | ...4     | Q451     | 0501-000389 TR-SMALL SIGNAL;KSC815,NPN,400mW,TO-92,T  |        |
| ...4     | EY75     | AA60-40011A EYELET;ID2.0,OD2.8,-,BST,- | S.N.A  | ...4     | Q461     | 0501-000389 TR-SMALL SIGNAL;KSC815,NPN,400mW,TO-92,T  |        |
| ...4     | EY76     | AA60-40011A EYELET;ID2.0,OD2.8,-,BST,- | S.N.A  | ...4     | Q471     | 0501-000389 TR-SMALL SIGNAL;KSC815,NPN,400mW,TO-92,T  |        |
| ...4     | EY77     | AA60-40011A EYELET;ID2.0,OD2.8,-,BST,- | S.N.A  | ...4     | Q474     | 0501-000389 TR-SMALL SIGNAL;KSC815,NPN,400mW,TO-92,T  |        |
| ...4     | EY78     | AA60-40011A EYELET;ID2.0,OD2.8,-,BST,- | S.N.A  | ...4     | Q481     | 0501-000389 TR-SMALL SIGNAL;KSC815,NPN,400mW,TO-92,T  |        |
| ...4     | EY79     | AA60-40011A EYELET;ID2.0,OD2.8,-,BST,- | S.N.A  | ...4     | Q482     | 0501-000283 TR-SMALL SIGNAL;KSA539,PNP,400mW,TO-92,T  |        |
| ...4     | EY80     | AA60-40011A EYELET;ID2.0,OD2.8,-,BST,- | S.N.A  | ...4     | Q851     | 0501-000389 TR-SMALL SIGNAL;KSC815,NPN,400mW,TO-92,T  |        |
| ...4     | EY81     | AA60-40011A EYELET;ID2.0,OD2.8,-,BST,- | S.N.A  | △        | QR401S   | 0501-000283 TR-SMALL SIGNAL;KSA539,PNP,400mW,TO-92,T  |        |
| ...4     | EY82     | AA60-40011A EYELET;ID2.0,OD2.8,-,BST,- | S.N.A  | ...4     | QS801    | 0501-000389 TR-SMALL SIGNAL;KSC815,NPN,400mW,TO-92,T  |        |
| ...4     | EY83     | AA60-40011A EYELET;ID2.0,OD2.8,-,BST,- | S.N.A  | ...4     | QS802    | 0501-000389 TR-SMALL SIGNAL;KSC815,NPN,400mW,TO-92,T  |        |
| ...4     | EY84     | AA60-40011A EYELET;ID2.0,OD2.8,-,BST,- | S.N.A  | ...4     | R301     | 2004-001897 R-METAL(S);43.2Kohm,1%,1/2W,AA,TP2.5x6.   |        |
| ...4     | EY85     | AA60-40011A EYELET;ID2.0,OD2.8,-,BST,- | S.N.A  | ...4     | R302     | 2004-001897 R-METAL(S);43.2Kohm,1%,1/2W,AA,TP2.5x6.   |        |
| ...4     | EY86     | AA60-40011A EYELET;ID2.0,OD2.8,-,BST,- | S.N.A  | ...4     | R303     | 2004-001984 R-METAL(S);26.7Kohm,1%,1/2W,AA,TP2.4x6.   |        |
| ...4     | EY87     | AA60-40011A EYELET;ID2.0,OD2.8,-,BST,- | S.N.A  | ...4     | R305     | 2004-001984 R-METAL(S);26.7Kohm,1%,1/2W,AA,TP2.4x6.   |        |
| ...4     | EY88     | AA60-40011A EYELET;ID2.0,OD2.8,-,BST,- | S.N.A  | ...4     | R306     | 2008-001076 R-FUSIBLE(S);1.8ohm,5%,2W,AF,TP,3.9x10mm  |        |
| ...4     | EY89     | AA60-40011A EYELET;ID2.0,OD2.8,-,BST,- | S.N.A  | ...4     | R307     | 2008-000290 R-FUSIBLE(S);2.4ohm,5%,2W,AF,TP,3.9x10mm  |        |
| ...4     | EY90     | AA60-40011A EYELET;ID2.0,OD2.8,-,BST,- | S.N.A  | ...4     | R308     | 2001-000016 R-CARBON(S);10HM,5%,1/2W,AA,TP,2.4X6.4MM  |        |



| Loc. No. | Code No.    | Description ; Specification              | Remark |
|----------|-------------|--|--------|
| ...      | AA60-00126B | SPACER-CAP;PROJ,EPDM,BLK                 | S.N.A  |
| ...      | AA60-00125B | SPACER-CRT;PROJ,SILICONE,D/GRAY          | S.N.A  |
| ...      | AA60-00074A | SPACER-DY;PJT,SILICON RUBBER,-,-,GRAY,   | S.N.A  |
| ..2      | BP91-00257A | ASSY CPT-G;HCM4215WX/XAA,P55A,DELTA71,GR |        |
| ...      | AA60-10011A | SCREW-TAPTITE;-SWRCH18A,M4,L12,HH,+,PC,  | S.N.A  |
| ...      | AA63-00076A | SPACER-LENS;PROJECTION,FELT -,-,BROWN    | S.N.A  |
| ...      | AA61-00810B | HOLDER-CAP;PROJ,PC,CLR                   | S.N.A  |
| ...      | AA61-00809B | HOLDER-CRT;PROJ,PC/ABS GF 20%,BLK        | S.N.A  |
| ...      | AA61-00807B | CASE-COUPLER,G;PROJ,ALDC,T8,BLK          | S.N.A  |
| ...      | AA61-00056B | BRACKET-LENS;PROJECTION,SECC,T1.6,-,-,-, | S.N.A  |
| ...      | AA27-00249A | DEFLECTION YOKE;-DPD-5292AA,S/S,7,29.1   |        |
| ...      | AA91-00722A | ASSY-BRKT,CRT;SECC T1.6,PROJ             |        |
| ....4    | AA61-00473B | BRACKET-CRT;53,SECC,T1.6,-,-,-,          | S.N.A  |
| ....4    | AA61-00615B | BRACKET-EARTH;54J8,PBS,TO.5,-,-,-,-,     | S.N.A  |
| ....4    | AA61-00812A | SPRING-WIRE;PROJ,STS,3.6                 | S.N.A  |
| ...      | AA67-00185A | LENS-PLATE;-SSM-65,SHADING PLATE         |        |
| ...      | AA67-00095A | LENS;-SSM-65,GREEN,-,-,-,C ELEMENT       |        |
| ...      | AA67-00092A | LENS-ASSY;-SSM-65,CLEAR A/B,-,-,-,-,     |        |
| ...      | AA39-00018A | LEAD CONNECTOR-ASSY;UL1015#22,UL/CSA,1P  |        |
| ...      | AA26-30006F | TRANS-FLYBACK;-FWZ-50A001C,55',30KV      |        |
| ...      | AA03-00201A | CDT MONO;P16LSG03HKA,FREE,3.30mH,2.20mH, |        |
| ...      | AA60-00127B | SPACER-LENS;PROJ,SILICONE,D/GRAY         | S.N.A  |
| ...      | AA60-00126B | SPACER-CAP;PROJ,EPDM,BLK                 | S.N.A  |
| ...      | AA60-00125B | SPACER-CRT;PROJ,SILICONE,D/GRAY          | S.N.A  |
| ...      | AA60-00074A | SPACER-DY;PJT,SILICON RUBBER,-,-,GRAY,   | S.N.A  |
| ..2      | BP91-00258A | ASSY CPT-B;HCM4215WX/XAA,P55A,DELTA71,BU |        |
| ...      | AA60-10011A | SCREW-TAPTITE;-SWRCH18A,M4,L12,HH,+,PC,  | S.N.A  |
| ...      | AA67-00093A | LENS;-SSM-65,CLEAR,-,-,-,C ELEMENT       |        |
| ...      | AA67-00092A | LENS-ASSY;-SSM-65,CLEAR A/B,-,-,-,-,     |        |
| ...      | AA63-00076A | SPACER-LENS;PROJECTION,FELT -,-,BROWN    | S.N.A  |
| ...      | AA61-00810B | HOLDER-CAP;PROJ,PC,CLR                   | S.N.A  |
| ...      | AA61-00808B | CASE-COUPLER,B;PROJ,ALDC,T8,BLK          | S.N.A  |
| ...      | AA33-00018A | MAGNET CONVERGENCE;JH 92LT - 36F,-,29.1M |        |
| ...      | AA27-00249A | DEFLECTION YOKE;-DPD-5292AA,S/S,7,29.1   |        |
| ...      | BP61-00009A | HOLDER-CRT;42W5,PC/ABS,BLK,GF20%         | S.N.A  |
| ...      | AA91-00722A | ASSY-BRKT,CRT;SECC T1.6,PROJ             |        |
| ....4    | AA61-00473B | BRACKET-CRT;53,SECC,T1.6,-,-,-,          | S.N.A  |
| ....4    | AA61-00615B | BRACKET-EARTH;54J8,PBS,TO.5,-,-,-,-,     | S.N.A  |
| ....4    | AA61-00812A | SPRING-WIRE;PROJ,STS,3.6                 | S.N.A  |
| ...      | AA67-00185A | LENS-PLATE;-SSM-65,SHADING PLATE         |        |
| ...      | AA61-00056B | BRACKET-LENS;PROJECTION,SECC,T1.6,-,-,-, | S.N.A  |
| ...      | AA39-00018A | LEAD CONNECTOR-ASSY;UL1015#22,UL/CSA,1P  |        |
| ...      | AA26-30006F | TRANS-FLYBACK;-FWZ-50A001C,55',30KV      |        |
| ...      | AA03-00202A | CDT MONO;P16LSG03BMB,FREE,3.30mH,2.20mH, |        |
| ...      | AA60-00128B | SPACER-CRT;PROJ(65),SILICONE,D/GRAY      | S.N.A  |
| ...      | AA60-00127B | SPACER-LENS;PROJ,SILICONE,D/GRAY         | S.N.A  |
| ...      | AA60-00126B | SPACER-CAP;PROJ,EPDM,BLK                 | S.N.A  |
| ...      | AA60-00074A | SPACER-DY;PJT,SILICON RUBBER,-,-,GRAY,   | S.N.A  |

**ASSY COVER FRONT**

|       |        |             |   |       |
|-------|--------|-------------|---|-------|
| 1     | *      | BP90-00007J | ASSY COVER FRONT;42W5,HCM4215WX/XAA       | S.N.A |
| ..2   | AC+BCM | 6003-001339 | SCREW-TAPTITE;HH,+,B,M4,L15,ZPC(BLK),SWR  | S.N.A |
| ..2   | BCM+CW | 6006-001094 | SCREW-ASS'Y WOOD;VWV,HH,+,M7,L32,ZPC(YEL) | S.N.A |
| ..2   | BF+BCM | AA60-10011A | SCREW-TAPTITE;-SWRCH18A,M4,L12,HH,+,PC,   | S.N.A |
| ..2   | BS+CF  | AA60-10011A | SCREW-TAPTITE;-SWRCH18A,M4,L12,HH,+,PC,   | S.N.A |
| ..2   | CF+CW  | 6005-001003 | SCREW-WOOD;HH,+,M4,L19,ZPC(BLK),SWRCH18A  |       |
| ..2   | CGH+BC | AA60-10011A | SCREW-TAPTITE;-SWRCH18A,M4,L12,HH,+,PC,   | S.N.A |
| ..2   | CP+KC  | 6003-001023 | SCREW-TAPTITE;RWH,+,B,M3,L10,ZPC(YEL),SW  | S.N.A |
| ..2   | CPC+CW | 6005-001003 | SCREW-WOOD;HH,+,M4,L19,ZPC(BLK),SWRCH18A  |       |
| ..2   | HP+BCM | AA60-10011A | SCREW-TAPTITE;-SWRCH18A,M4,L12,HH,+,PC,   | S.N.A |
| ..2   | HV+BCM | AA60-10011A | SCREW-TAPTITE;-SWRCH18A,M4,L12,HH,+,PC,   | S.N.A |
| ..2   | IS+CW  | 6005-001003 | SCREW-WOOD;HH,+,M4,L19,ZPC(BLK),SWRCH18A  |       |
| ..2   |        | BP91-00005D | ASSY-CABINET,WOOD;WOOD,MJ,JU,42W5         | S.N.A |
| ..3   | SPK+CW | AA60-10051A | SCREW-WOOD;-SWRCH18A,M4,L16,PH,+,ZP       | S.N.A |
| ..3   |        | AA61-00058D | HOLDER-JERSEY;W3,ABS V0,GRAY,G4309        | S.N.A |
| ..3   |        | AA61-00533B | BRACKET-GRILLE;43,54,62J8,SECC-1 ,TO.5,-  | S.N.A |
| ..3   |        | AA64-02724A | CABINET-WOOD;42W5,WOOD,SDE8336R           | S.N.A |
| ..3   |        | AA98-00049A | ASSY-LEAD,CON;-LEAD-CON,CORE,AA39-20505   | S.N.A |
| ....4 |        | 3301-001201 | CORE-FERRITE;AE,21x11x32mm,1500,280G      |       |
| ..3   |        | BP61-00019A | HOLDER-PALLET;42W5,HIPS HB,BLK            | S.N.A |
| ..3   |        | BP61-00035A | BRACKET-GRILLE;42W5,SECC-1,T1.0           | S.N.A |
| ..3   |        | AA61-00506B | HOLDER-CRT,MAIN;43,54,62J8,HIPS,-,-,-,BL  | S.N.A |
| ..3   |        | 3001-000279 | SPEAKER;30W,8ohm,91dB,20Hz                |       |

| Loc. No. | Code No.    | Description ; Specification              | Remark                                   |       |
|----------|-------------|--|--|-------|
| ...      | 3001-001107 | SPEAKER;20W,8ohm,95dB,1300Hz             |  |       |
| ...      | AA39-00086A | LEAD CONNECTOR-ASSY;-2,ZUF,REC,REC,200MM |  |       |
| ...      | AA61-00094G | HOLDER-RAIL;42W5,ABS HB,L480,BLK,2HOLE   | S.N.A                                    |       |
| ...      | AA61-00097A | HOLDER-WIRE;-NYLON 6/6,-,-,-,NTR,-       | S.N.A                                    |       |
| ..2      | BP91-00006C | ASSY-C/FRONT,MASK;HIPS HB,G4309,DG703P,  |  |       |
| ...      | AA64-02727D | CABINET-FRONT,MASK TOP;42W5,HIPS,HB,G430 | S.N.A                                    |       |
| ...      | AA64-02211D | BADGE-BRAND                              |  |       |
|          |             | ;72MM,AL FORGING,DG703P,SAJSU            | S.N.A                                    |       |
| ...      | AA61-01133A | VELCRO-B;COMMANDO,BST1 1/4H              | S.N.A                                    |       |
| ...      | 6003-001019 | SCREW-TAPTITE;RH,+,B,M4,L12,ZPC(BLK),SWR | S.N.A                                    |       |
| ..2      | BP61-00023B | BRACKET-SCREEN,ASSY(TOP);42W5,SECC,T1.0, | S.N.A                                    |       |
| ...      | AA61-01121A | BRACKET-SCREEN,TB;42W5,SECC,T1.0         | S.N.A                                    |       |
| ...      | BP61-00052A | HOLDER-WIRE;PJT,NYLON,66,NATURAL         | S.N.A                                    |       |
| ...      | BP61-00043A | HOLDER-SENSOR;W9,ABS ,HB,BLK             | S.N.A                                    |       |
| ..2      | BP61-00024B | BRACKET-SCREEN,ASSY(BOT);42W5,SECC,T1.0, | S.N.A                                    |       |
| ...      | AA61-01121A | BRACKET-SCREEN,TB;42W5,SECC,T1.0         | S.N.A                                    |       |
| ...      | AA65-00020A | CLAMP CORE-WIRE;55W9,NYLON 66            | S.N.A                                    |       |
| ...      | BP61-00043A | HOLDER-SENSOR;W9,ABS ,HB,BLK             | S.N.A                                    |       |
| ...      | BP61-00052A | HOLDER-WIRE;PJT,NYLON,66,NATURAL         | S.N.A                                    |       |
| ..2      | BP61-00025B | BRACKET-SCREEN,ASSY(R);42W5,SECC,T1.0,NE | S.N.A                                    |       |
| ...      | AA61-01121A | BRACKET-SCREEN,TB;42W5,SECC,T1.0         | S.N.A                                    |       |
| ...      | BP61-00043A | HOLDER-SENSOR;W9,ABS ,HB,BLK             | S.N.A                                    |       |
| ...      | BP61-00052A | HOLDER-WIRE;PJT,NYLON,66,NATURAL         | S.N.A                                    |       |
| ..2      | BP61-00026B | BRACKET-SCREEN,ASSY(L);42W5,SECC,T1.0,NE | S.N.A                                    |       |
| ...      | AA61-01121A | BRACKET-SCREEN,TB;42W5,SECC,T1.0         | S.N.A                                    |       |
| ...      | BP61-00043A | HOLDER-SENSOR;W9,ABS ,HB,BLK             | S.N.A                                    |       |
| ...      | BP61-00052A | HOLDER-WIRE;PJT,NYLON,66,NATURAL         | S.N.A                                    |       |
| ..2      | BP91-00008E | ASSY-PANNEL,CONTROL;HIPS HB,G4309,SVM30  |  |       |
| ...      | 6003-001026 | SCREW-TAPTITE;RH,+,B,M4,L15,ZPC(BLK),SWR |  |       |
| ...      | 6003-001019 | SCREW-TAPTITE;RH,+,B,M4,L12,ZPC(BLK),SWR | S.N.A                                    |       |
| ...      | Z           | 6003-001019                              | SCREW-TAPTITE;RH,+,B,M4,L12,ZPC(BLK),SWR | S.N.A |
| ...      | AA64-02726B | CABINET-PANEL CONTROL;42W5,HIPS,HB,G4309 | S.N.A                                    |       |
| ...      | AA64-02739B | KNOB-CONTROL;42W5,ABS,HB,G3676,SVM3012   |  |       |
| ...      | AA64-02740B | KNOB-POWER;42W5,ABS,HB,G3676,SVM3012     |  |       |
| ...      | AA64-02742A | WINDOW-RMC,LED;42W5,PC,CLR               | S.N.A                                    |       |
| ...      | BP64-00035G | INLAY-DECORATION;42W5,AL,TO.4,MJ,JU      | S.N.A                                    |       |
| ...      | AA61-01130B | GUIDE-KNOB,CONTROL;42W5,ABS HB,G3676,SVM | S.N.A                                    |       |
| ...      | AA61-01132A | VELCRO-A;COMMANDO,BST1 1/4H              | S.N.A                                    |       |
| ...      | AA61-01133A | VELCRO-B;COMMANDO,BST1 1/4H              | S.N.A                                    |       |
| ...      | AA61-20129A | HOLDER-WIRE;-NYLON-66,-,-,-,NTR,DAFC-25  | S.N.A                                    |       |
| ...      | AA61-60003J | SPRING-CS;SUS304,-,-,OD6,N7,OD6,-,-,-,   | S.N.A                                    |       |
| ..2      | BP91-00007G | ASSY-FRONT,BOT;HIPS V0,G4309,DG703P,42W  |  |       |
| ...      | 6003-001019 | SCREW-TAPTITE;RH,+,B,M4,L12,ZPC(BLK),SWR | S.N.A                                    |       |
| ...      | BP73-00001A | RUBBER-SHEET;42W5,NBB RUBBER,GRAY,10*20  |  |       |
| ...      | AA64-02743B | BADGE-DECORATION;42W5,AL,DG703P,NI,RS    | S.N.A                                    |       |
| ...      | AA64-02725G | CABINET-FRONT,BOT;42W5,HIPS,V0,G4309,DG7 | S.N.A                                    |       |
| ...      | AA61-01132A | VELCRO-A;COMMANDO,BST1 1/4H              | S.N.A                                    |       |
| ..2      | AA73-00005B | RUBBER-CAP;FLAT,PRJ,SILICONE RUBBER,WHIT |  |       |
| ..2      | BP64-00029A | INLAY-SUPPORT;42W5,PS SHEET,TO.5,94V0    | S.N.A                                    |       |
| ..2      | AA26-00101A | TRANS FBT;FWZ50A001E/FFA97513B,12KV,5P-  |  |       |
| ..2      | AA60-00072B | SPACER-COVER,DUST;43,54,62J9,SPONGE 94HF | S.N.A                                    |       |
| ..2      | AA61-00475B | BRACKET-CRT,MAIN;54,SECC,T1.6,-,-,-,-    | S.N.A                                    |       |
| ..2      | AA67-00193A | SCREEN-TINT;42W,958*550,T=0.73,P=052     |  |       |
| ..2      | AA67-00193B | SCREEN-FRESNEL;42W,960*552,T=2.0         |  |       |
| ..2      | AA67-00207A | SCREEN-FILTER;T=82%,960*552*2,G=110,AG   |  |       |
| ..2      | BP39-00009A | LEAD CONNECTOR ASSY;P54A/SVP-42W5,UL2547 |  |       |

**ASSY COVER REAR**

|     |        |             |  |       |
|-----|--------|-------------|--|-------|
| 1   | *      | BP90-00008D | ASSY COVER REAR;42W5,HCM4215WX/XAA       | S.N.A |
| ..2 | BM+CBT | 6003-001026 | SCREW-TAPTITE;RH,+,B,M4,L15,ZPC(BLK),SWR | S.N.A |
| ..2 | CBB+CB | 6003-001026 | SCREW-TAPTITE;RH,+,B,M4,L15,ZPC(BLK),SWR | S.N.A |
| ..2 | CBT+CF | 6003-001026 | SCREW-TAPTITE;RH,+,B,M4,L15,ZPC(BLK),SWR | S.N.A |
| ..2 | CBT+CP | 6003-001026 | SCREW-TAPTITE;RH,+,B,M4,L15,ZPC(BLK),SWR | S.N.A |
| ..2 | CBT+CW | 6005-001003 | SCREW-WOOD;HH,+,M4,L19,ZPC(BLK),SWRCH18A |       |
| ..2 | HC+CW  | 6005-001003 | SCREW-WOOD;HH,+,M4,L19,ZPC(BLK),SWRCH18A |       |
| ..2 | TB+RJK | 6003-001026 | SCREW-TAPTITE;RH,+,B,M4,L15,ZPC(BLK),SWR | S.N.A |
| ..2 | TB+TU  | 6003-001026 | SCREW-TAPTITE;RH,+,B,M4,L15,ZPC(BLK),SWR | S.N.A |
| ..2 |        | AA65-30008A | CLAMP-CORD;-PE,HB,-,BLK,-                | S.N.A |
| ..2 |        | BP61-00008A | BRACKET-MIRROR,ASSY;42W5,SECC,T1.0,01123 | S.N.A |
| ..3 |        | AA61-01123A | BRACKET-MIRROR;42W5,SECC,T1.0            | S.N.A |
| ..3 |        | BP60-00005A | SPACER-SPONGE;42W5,RUBBER-SPONGE,T3      | S.N.A |
| ..3 |        | BP96-00038A | ASSY COVER P-TERMINAL,ANT;42W5,HIPS V0,B | S.N.A |
| ..3 |        | AA64-02836B | INLAY-TERMINAL,NT;42W5,PS SHEET,TO.5,BLK | S.N.A |

Electrical Parts List

| Loc. No.               | Code No.    | Description ; Specification               | Remark                                | Loc. No.              | Code No. | Description ; Specification | Remark      |  |       |
|------------------------|-------------|---|---------------------------------------|-----------------------|----------|-----------------------------|-------------|--|-------|
| ...3                   | AA65-00023A | TERMINAL-BOARD,ANT,;HIPS V0,BLK           | S.N.A                                 |                       |          |                             |             |  |       |
| ..2                    | AA67-00204A | MIRROR-FRONT;42W5,FSM,870*633*446         |                                       |                       |          |                             |             |  |       |
| ..2                    | AA64-60449B | INLAY-COVER;SP-434,JMF,PS,T0.5,149.3X69.5 | S.N.A                                 |                       |          |                             |             |  |       |
| ..2                    | AA64-60421C | INLAY-COVER;-;PS,T0.3,-;-BLK,SEA          | S.N.A                                 |                       |          |                             |             |  |       |
| ..2                    | AA64-02729B | CABINET-BACK,BOT;42W5,HIPS,V0,G4309       |                                       |                       |          |                             |             |  |       |
| ..2                    | AA64-02728A | CABINET-BACK,TOP;42W5,HIPS,HB,G4309       |                                       |                       |          |                             |             |  |       |
| <b>ASSY P/MATERIAL</b> |             |   |                                       | <b>ASSY LABE</b>      |          |                             |             |  |       |
| 1                      | *           | BP92-00009A                               | ASSY P/MATERIAL;42W5,SVP-42W5HR       | S.N.A                 | 1        | *                           | BP92-00034A | ASSY LABEL;HCM4215WX/MVT,P55A            | S.N.A |
| ..2                    |             | AA61-20285A                               | HOLDER-BOX;3456,PP,-;-;WHT,VO         | S.N.A                 |          |                             |             |  |       |
| ..2                    |             | AA60-40006A                               | PIN-STAPLE;-;-;H18,33X17.8X2.4,-;AUTO | S.N.A                 |          |                             |             |  |       |
| <b>ASSY BOX</b>        |             |   |                                       | <b>ASSY ACCESSORY</b> |          |                             |             |  |       |
| 1                      | *           | BP92-00008H                               | ASSY BOX;42W5,HCM4215WX/XAA           | S.N.A                 | 1        | *                           | BP92-00012A | ASSY ACCESSORY;HCM4215WX/MVT,P55A        | S.N.A |
|                        |             |   |                                       |                       | ..2      |                             | BP68-00021A | MANUAL USERS;HCM4215W,ENG,W/P100G,P55A,B |       |
|                        |             |   |                                       |                       | ..2      |                             | AA59-00262A | REMOCON;TM63,COMMONDO,48,G6671B,EX,S/S   |       |
|                        |             |   |                                       |                       | ..2      |                             | AA39-00006A | CABLE-RCA;3000MM                         |       |



## 7-2 HCM4216WX/XAA

| Loc. No.            | Code No. | Description ; Specification                           | Remark | Loc. No. | Code No. | Description ; Specification                           | Remark |
|---------------------|----------|---|--------|----------|----------|---|--------|
| <b>ASSY CHASSIS</b> |          |   |        |          |          |   |        |
| 1                   | *        | BP91-00266A ASSY CHASSIS;HCM4216WX/XAA,P55A,CHASSIS   |        | ...3     | V561     | 3704-001019 SOCKET-CRT;10P;29.1PI,35.5PI,AU30U,-      |        |
| ..2                 | PM+HC    | 6003-001023 SCREW-TAPTITE;RWH,+,B,M3,L10,ZPC(YEL),SW  | S.N.A  | ...3     | VR501    | 2101-000321 VR-ROTARY;1Mohm,-,0.6W,SIDE               |        |
| ..2                 | PP+HC    | 6003-001023 SCREW-TAPTITE;RWH,+,B,M3,L10,ZPC(YEL),SW  | S.N.A  | ...3     | VR531    | 2101-000321 VR-ROTARY;1Mohm,-,0.6W,SIDE               |        |
| ..2                 | SMW-GN   | AA39-20010D LEAD CONNECTOR-ASSY;,1P,YFH800-01,S,400,  |        | ...3     | VR561    | 2101-000321 VR-ROTARY;1Mohm,-,0.6W,SIDE               |        |
| ..2                 |          | AA94-08576A ASSY PCB MISC-CONTROL;HCM4215W,P55A       |        | ...3     |          | 3301-001201 CORE-FERRITE;AE,21x11x32mm,1500,280G      |        |
| ...3                | CNW01    | AA39-00223A LEAD CONNECTOR ASSY;,11P;67096-011,35155  |        | ...3     |          | AA39-20010B LEAD CONNECTOR-ASSY;,1P,YFH800-01,S,500,  |        |
| ...3                | CNW02    | AA39-00259A LEAD CONNECTOR ASSY;,UL1007#26,UL/CSA,3P  |        | ...3     |          | 0202-000187 SOLDER-WIRE FLUX;-,RS60S,D1,2.63Sn/37Pb   | S.N.A  |
| ...3                | CNY01    | 3711-003353 CONNECTOR-HEADER;BOX,11P,1R,2.5mm,ANGLE   |        | ...3     |          | AA97-07608A ASSY AUTO-CRT;HCM4215W                    | S.N.A  |
| ...3                | CNY02    | 3711-000447 CONNECTOR-HEADER;3WALL,3P,1R,2.5mm,ANGLE  |        | ...4     | C361     | 2306-000122 C-FILM,MPEF;100nF,5%,50V,TP,7.3x4.0x5.0mm |        |
| ...3                | LEDY01   | 0601-001381 LED;ROUND,RED/GRN,5.0MM,650/563NM         |        | ...4     | C371     | 2401-000302 C-AL;100uF,20%,25V,GP,TP,6.3x11,5         |        |
| ...3                | RMY01    | AA32-00012A MODULE REMOCON;ORC-50HF2,38KHZ,940NM,MES  |        | ...4     | C372     | 2401-000480 C-AL;10uF,20%,50V,GP,TP,5x11,5            |        |
| ...3                | SWY01    | 3404-001006 SWITCH-TACT;12V,50mA,160gf,6x6mm,SPST     |        | ...4     | C373     | 2401-000302 C-AL;100uF,20%,25V,GP,TP,6.3x11,5         |        |
| ...3                | SWY02    | 3404-001006 SWITCH-TACT;12V,50mA,160gf,6x6mm,SPST     |        | ...4     | C374     | 2401-001621 C-AL;6.8uF,20%,450V,GP,TP,13x20,5         |        |
| ...3                | SWY03    | 3404-001006 SWITCH-TACT;12V,50mA,160gf,6x6mm,SPST     |        | ...4     | C376     | 2201-000556 C-CERAMIC,DISC;0.47nF,10%,500V,Y5P,TP,5   |        |
| ...3                | SWY04    | 3404-001006 SWITCH-TACT;12V,50mA,160gf,6x6mm,SPST     |        | ...4     | C502     | 2401-000027 C-AL;4.7uF,20%,50V,GP,TP,5x11,5           |        |
| ...3                | SWY05    | 3404-001006 SWITCH-TACT;12V,50mA,160gf,6x6mm,SPST     |        | ...4     | C503     | 2201-000119 C-CERAMIC,DISC;100nF,+80-20%,50V,Y5V,TP,  |        |
| ...3                | SWY06    | 3404-001006 SWITCH-TACT;12V,50mA,160gf,6x6mm,SPST     |        | ...4     | C504     | 2401-001571 C-AL;47uF,+20%-0%,50V,GP,TP,8x11,5        |        |
| ...3                | SWY07    | 3404-001006 SWITCH-TACT;12V,50mA,160gf,6x6mm,SPST     |        | ...4     | C505     | 2305-000149 C-FILM,MPEF;100nF,5%,100V,TP,12x12.5x6.5  |        |
| ...3                | SWY08    | 3404-001006 SWITCH-TACT;12V,50mA,160gf,6x6mm,SPST     |        | ...4     | C506     | 2401-000430 C-AL;10uF,20%,250V,GP,TP,10x16mm,5m       |        |
| ...3                |          | 3301-001201 CORE-FERRITE;AE,21x11x32mm,1500,280G      |        | ...4     | C507     | 2305-000154 C-FILM,MPEF;100nF,5%,400V,TP,21.5x6.5x11  |        |
| ...3                |          | 0202-000187 SOLDER-WIRE FLUX;-,RS60S,D1,2.63Sn/37Pb   | S.N.A  | ...4     | C510     | 2401-000430 C-AL;10uF,20%,250V,GP,TP,10x16mm,5m       |        |
| ...3                |          | AA97-07423A ASSY AUTO;0000                            | S.N.A  | ...4     | C512     | 2201-000723 C-CERAMIC,DISC;4.7nF,20%,3KV,Y5U,TP,16x5  |        |
| ...4                | CY01     | 2401-002009 C-AL;100uF,20%,16V,GP,TP,6.3x7,5          |        | ...4     | C513     | 2201-000983 C-CERAMIC,DISC;1nF,10%,2kV,Y5P,TP,9x5,7   |        |
| ...4                | DZY02    | 0403-000510 DIODE-ZENER;MTZJ6.2B,6.2V,5.96-6.27V,500  |        | ...4     | C514     | 2201-000599 C-CERAMIC,DISC;0.56nF,10%,500V,Y5P,TP,5   |        |
| ...4                | DZY03    | 0403-000510 DIODE-ZENER;MTZJ6.2B,6.2V,5.96-6.27V,500  |        | ...4     | C532     | 2401-000027 C-AL;4.7uF,20%,50V,GP,TP,5x11,5           |        |
| ...4                | PCB      | BP41-00001C PCB-CONTROL;SVP-42W5HD,FR-1,L,C,1.6T,33   | S.N.A  | ...4     | C533     | 2201-000119 C-CERAMIC,DISC;100nF,+80-20%,50V,Y5V,TP,  |        |
| ...4                | QY01     | 0504-000123 TR-DIGITAL;KSR1010,NPN,300mW,10K,TO-92,T  |        | ...4     | C534     | 2401-001571 C-AL;47uF,+20%-0%,50V,GP,TP,8x11,5        |        |
| ...4                | RY02     | 2001-000832 R-CARBON;510OHM,5%,1/8W,AA,TP,1.8X3.2MM   |        | ...4     | C535     | 2305-000149 C-FILM,MPEF;100nF,5%,100V,TP,12x12.5x6.5  |        |
| ...4                | RY03     | 2001-000832 R-CARBON;510OHM,5%,1/8W,AA,TP,1.8X3.2MM   |        | ...4     | C536     | 2401-000430 C-AL;10uF,20%,250V,GP,TP,10x16mm,5m       |        |
| ...4                | RY04     | 2001-000429 R-CARBON;1KOHM,5%,1/8W,AA,TP,1.8X3.2MM    |        | ...4     | C537     | 2305-000154 C-FILM,MPEF;100nF,5%,400V,TP,21.5x6.5x11  |        |
| ...4                | RY05     | 2001-000832 R-CARBON;510OHM,5%,1/8W,AA,TP,1.8X3.2MM   |        | ...4     | C540     | 2401-000430 C-AL;10uF,20%,250V,GP,TP,10x16mm,5m       |        |
| ...4                | RY06     | 2001-000924 R-CARBON;680OHM,5%,1/8W,AA,TP,1.8X3.2MM   |        | ...4     | C541     | 2201-000723 C-CERAMIC,DISC;4.7nF,20%,3KV,Y5U,TP,16x5  |        |
| ...4                | RY07     | 2001-000020 R-CARBON(S);220OHM,5%,1/2W,AA,TP,2.4X6.4M |        | ...4     | C543     | 2201-000983 C-CERAMIC,DISC;1nF,10%,2kV,Y5P,TP,9x5,7   |        |
| ...4                | RY08     | 2001-001108 R-CARBON(S);22KOHM,5%,1/2W,AA,TP,2.4X6.4  |        | ...4     | C544     | 2201-000599 C-CERAMIC,DISC;0.56nF,10%,500V,Y5P,TP,5   |        |
| ...4                | RY09     | 2001-000109 R-CARBON(S);470OHM,5%,1/2W,AA,TP,2.4X6.4  |        | ...4     | C562     | 2401-000027 C-AL;4.7uF,20%,50V,GP,TP,5x11,5           |        |
| ..2                 |          | AA94-08582A ASSY PCB MISC-CRT;COMMANDO,C2             |        | ...4     | C563     | 2201-000119 C-CERAMIC,DISC;100nF,+80-20%,50V,Y5V,TP,  |        |
| ...3                | CN501    | 3711-002648 CONNECTOR-HEADER;BOX,9P,1R,2.5mm,STRAIGH  |        | ...4     | C564     | 2401-001571 C-AL;47uF,+20%-0%,50V,GP,TP,8x11,5        |        |
| ...3                | CN502    | 3711-003052 CONNECTOR-HEADER;BOX,10P,1R,2.5MM,STRAIG  |        | ...4     | C565     | 2305-000149 C-FILM,MPEF;100nF,5%,100V,TP,12x12.5x6.5  |        |
| ...3                | CN502B   | 3711-003052 CONNECTOR-HEADER;BOX,10P,1R,2.5MM,STRAIG  |        | ...4     | C566     | 2401-000430 C-AL;10uF,20%,250V,GP,TP,10x16mm,5m       |        |
| ...3                | CN503    | 3711-003973 CONNECTOR-HEADER;BOX,11P,1R,2.5mm,STRAIG  |        | ...4     | C567     | 2305-000154 C-FILM,MPEF;100nF,5%,400V,TP,21.5x6.5x11  |        |
| ...3                | CN503R   | 3711-003973 CONNECTOR-HEADER;BOX,11P,1R,2.5mm,STRAIG  |        | ...4     | C570     | 2401-000430 C-AL;10uF,20%,250V,GP,TP,10x16mm,5m       |        |
| ...3                | CN504    | 3711-002645 CONNECTOR-HEADER;BOX,6P,1R,2.5mm,STRAIGH  |        | ...4     | C571     | 2201-000723 C-CERAMIC,DISC;4.7nF,20%,3KV,Y5U,TP,16x5  |        |
| ...3                | CNW401   | AA39-20027B LEAD CONNECTOR-ASSY;,6P;67096-006,S,400,  |        | ...4     | C573     | 2201-000983 C-CERAMIC,DISC;1nF,10%,2kV,Y5P,TP,9x5,7   |        |
| ...3                | CNW501   | AA39-20031D LEAD CONNECTOR-ASSY;,9P;67096-009,S,500,  |        | ...4     | C574     | 2201-000599 C-CERAMIC,DISC;0.56nF,10%,500V,Y5P,TP,5   |        |
| ...3                | CNW502   | AA39-00112A LEAD CONNECTOR-ASSY;,10P;35155-1000,S,30  |        | ...4     | D361     | 0401-000005 DIODE-SWITCHING;1N4148,100V,200mA,DO-35,  |        |
| ...3                | CNW503   | AA39-00120F LEAD CONNECTOR ASSY;SIR-T165,UL1007#26,U  |        | ...4     | D362     | 0401-000005 DIODE-SWITCHING;1N4148,100V,200mA,DO-35,  |        |
| ...3                | GBW-GN   | AA39-20010D LEAD CONNECTOR-ASSY;,1P,YFH800-01,S,400,  |        | ...4     | D371     | 0401-000005 DIODE-SWITCHING;1N4148,100V,200mA,DO-35,  |        |
| ...3                | GBW-SC   | BP39-00004C LEAD CONNECTOR ASSY;P55A/HCM4215W,UL3239  |        | ...4     | D372     | 0402-000243 DIODE-RECTIFIER;RC2-V1,2000V,0.2A,DO-201  |        |
| ...3                | GRW-GN   | AA39-20010D LEAD CONNECTOR-ASSY;,1P,YFH800-01,S,400,  |        | ...4     | D501     | 0402-000546 DIODE-RECTIFIER;TVR10G,400V,1.0A,DO-41,T  |        |
| ...3                | GRW-SC   | BP39-00004C LEAD CONNECTOR ASSY;P55A/HCM4215W,UL3239  |        | ...4     | D502     | 0402-000546 DIODE-RECTIFIER;TVR10G,400V,1.0A,DO-41,T  |        |
| ...3                | IC501    | AA96-50311L ASSY H/S;- ,AMP,AA62-30175D ,TDA6111Q.HE  | S.N.A  | ...4     | D503     | 0402-000493 DIODE-RECTIFIER;1R5GU41,400V,1.5A,DO-15L  |        |
| ...3                | IC531    | AA96-50311L ASSY H/S;- ,AMP,AA62-30175D ,TDA6111Q.HE  | S.N.A  | ...4     | D504     | 0401-000005 DIODE-SWITCHING;1N4148,100V,200mA,DO-35,  |        |
| ...3                | IC561    | AA96-50311L ASSY H/S;- ,AMP,AA62-30175D ,TDA6111Q.HE  | S.N.A  | ...4     | D509     | 0401-000005 DIODE-SWITCHING;1N4148,100V,200mA,DO-35,  |        |
| ...4                |          | 1201-001131 IC-VIDEO AMP;6111,SIP,9P,-,SINGLE,-,PLAS  |        | ...4     | D510     | 0401-000005 DIODE-SWITCHING;1N4148,100V,200mA,DO-35,  |        |
| ...4                |          | 6003-000334 SCREW-TAPTITE;RH,+,2S,M3,L6,ZPC(YEL),SWR  | S.N.A  | ...4     | D531     | 0402-000546 DIODE-RECTIFIER;TVR10G,400V,1.0A,DO-41,T  |        |
| ...4                |          | AA62-30175D HEAT-SINK,PS;- ,SECC,T1.0,-,33X15X30 FT-2 | S.N.A  | ...4     | D532     | 0402-000546 DIODE-RECTIFIER;TVR10G,400V,1.0A,DO-41,T  |        |
| ...4                | Q371     | AA96-00244H ASSY H/S;SCREW,2SC4636(2),CRT,SLICON-OIL  | S.N.A  | ...4     | D533     | 0402-000493 DIODE-RECTIFIER;1R5GU41,400V,1.5A,DO-15L  |        |
| ...4                |          | 0205-000129 GREASE-SILICON;SC102,JAPAN                | S.N.A  | ...4     | D561     | 0402-000546 DIODE-RECTIFIER;TVR10G,400V,1.0A,DO-41,T  |        |
| ...4                |          | 0502-000442 TR-POWER;2SC4636RB,NPN,2W,TO-220,ST,10-   |        | ...4     | D562     | 0402-000546 DIODE-RECTIFIER;TVR10G,400V,1.0A,DO-41,T  |        |
| ...4                |          | 6003-000335 SCREW-TAPTITE;RH,+,2S,M3,L6,ZPC(YEL),SWR  | S.N.A  | ...4     | D563     | 0402-000546 DIODE-RECTIFIER;TVR10G,400V,1.0A,DO-41,T  |        |
| ...4                |          | AA62-00046A HEAT SINK,PS;- ,T1.0,-,D1(DREAM) 60X25X   | S.N.A  | ...4     | D566     | 0402-000546 DIODE-RECTIFIER;TVR10G,400V,1.0A,DO-41,T  |        |
| ...3                | RPW-SC   | BP39-00004B LEAD CONNECTOR ASSY;P55A/HCM4215W,UL3239  |        | ...4     | D567     | 0402-000546 DIODE-RECTIFIER;TVR10G,400V,1.0A,DO-41,T  |        |
| ...3                | SCW-GN   | AA39-00198D LEAD CONNECTOR ASSY;P55A/HCM4215W,UL1617  |        | ...4     | D562     | 0402-000546 DIODE-RECTIFIER;TVR10G,400V,1.0A,DO-41,T  |        |
| ...3                | SG301    | 4715-001050 SURGE ABSORBER;2.4kV,20%,1500A,-,DISC-RA  |        | ...4     | D563     | 0402-000546 DIODE-RECTIFIER;TVR10G,400V,1.0A,DO-41,T  |        |
| ...3                | SG502    | AA27-00084A COIL;S-23,-,-,-,-,-,S-23,5000Mohm MIN,    |        | ...4     | D566     | 0402-000546 DIODE-RECTIFIER;TVR10G,400V,1.0A,DO-41,T  |        |
| ...3                | SG532    | AA27-00084A COIL;S-23,-,-,-,-,-,S-23,5000Mohm MIN,    |        | ...4     | D567     | 0402-000546 DIODE-RECTIFIER;TVR10G,400V,1.0A,DO-41,T  |        |
| ...3                | SG562    | AA27-00084A COIL;S-23,-,-,-,-,-,S-23,5000Mohm MIN,    |        | ...4     | DZ501    | 0402-000493 DIODE-RECTIFIER;1R5GU41,400V,1.5A,DO-15L  |        |
| ...3                | V501     | 3704-001019 SOCKET-CRT;10P;29.1PI,35.5PI,AU30U,-      |        | ...4     | DZ502    | 0403-000334 DIODE-ZENER;MTZJ13B,13V,12.55-13.21V,500  |        |
| ...3                | V531     | 3704-001019 SOCKET-CRT;10P;29.1PI,35.5PI,AU30U,-      |        | ...4     | DZ503    | 0403-000708 DIODE-ZENER;MTZJ13B,13V,12.55-13.21V,500  |        |
| ...3                |          |   |        | ...4     | DZ531    | 0403-000334 DIODE-ZENER;UZZ.7BSA,2.7V,2.54-2.75V,500  |        |
| ...3                |          |   |        | ...4     | DZ532    | 0403-000508 DIODE-ZENER;MTZJ5.6B,5.6V,5.45-5.73V,500  |        |
| ...3                |          |   |        | ...4     | DZ533    | 0403-000708 DIODE-ZENER;MTZJ13B,13V,12.55-13.21V,500  |        |
| ...3                |          |   |        | ...4     | DZ561    | 0403-000334 DIODE-ZENER;UZZ.7BSA,2.7V,2.54-2.75V,500  |        |
| ...3                |          |   |        | ...4     | DZ562    | 0403-000508 DIODE-ZENER;MTZJ5.6B,5.6V,5.45-5.73V,500  |        |
| ...3                |          |   |        | ...4     | DZ563    | 0403-000708 DIODE-ZENER;MTZJ13B,13V,12.55-13.21V,500  |        |
| ...3                |          |   |        | ...4     | EL01     | AA60-40011B EYELET;ID2.2,OD3.2,-,BSP,-                | S.N.A  |
| ...3                |          |   |        | ...4     | EL02     | AA60-40011B EYELET;ID2.2,OD3.2,-,BSP,-                | S.N.A  |

| Loc. No. | Code No. | Description ; Specification                          | Remark | Loc. No. | Code No. | Description ; Specification                           | Remark |
|----------|----------|--|--------|----------|----------|---|--------|
| ....4    | EL03     | AA60-40011A EYELET;ID2.0,0D2.8,-,-,BST,-             | S.N.A  | ....4    | R502     | 2001-000995 R-CARBON;820OHM,5%,1/8W,AA,TP,1.8X3.2MM   |        |
| ....4    | EL04     | AA60-40011B EYELET;ID2.2,0D3.2,-,-,BSP,-             | S.N.A  | ....4    | R503     | 2001-000429 R-CARBON;1KOHM,5%,1/8W,AA,TP,1.8X3.2MM    |        |
| ....4    | EL05     | AA60-40011B EYELET;ID2.2,0D3.2,-,-,BSP,-             | S.N.A  | ....4    | R504     | 2001-000006 R-CARBON;2.4KOHM,5%,1/8W,AA,TP,1.8X3.2MM  |        |
| ....4    | EL06     | AA60-40011A EYELET;ID2.0,0D2.8,-,-,BST,-             | S.N.A  | ....4    | R505     | 2001-000362 R-CARBON;1500HM,5%,1/8W,AA,TP,1.8X3.2MM   |        |
| ....4    | EL503    | AA60-40011B EYELET;ID2.2,0D3.2,-,-,BSP,-             | S.N.A  | ....4    | R506     | 2001-001049 R-CARBON(S);1.3KOHM,5%,1/2W,AA,TP,2.4X6.4 |        |
| ....4    | EL504    | AA60-40011B EYELET;ID2.2,0D3.2,-,-,BSP,-             | S.N.A  | ....4    | R507     | 2001-001088 R-CARBON(S);1KOHM,5%,1/2W,AA,TP,2.4X6.4M  |        |
| ....4    | EL505    | AA60-40011B EYELET;ID2.2,0D3.2,-,-,BSP,-             | S.N.A  | ....4    | R508     | 2003-000738 R-METAL OXIDE(S);56Kohm,5%,2W,AA,TP,4x12  |        |
| ....4    | EL533    | AA60-40011B EYELET;ID2.2,0D3.2,-,-,BSP,-             | S.N.A  | ....4    | R509     | 2001-000734 R-CARBON;4.7KOHM,5%,1/8W,AA,TP,1.8X3.2MM  |        |
| ....4    | EL534    | AA60-40011B EYELET;ID2.2,0D3.2,-,-,BSP,-             | S.N.A  | ....4    | R510     | 2001-000908 R-CARBON;62KOHM,5%,1/8W,AA,TP,1.8X3.2MM   |        |
| ....4    | EL535    | AA60-40011B EYELET;ID2.2,0D3.2,-,-,BSP,-             | S.N.A  | ....4    | R511     | 2001-000281 R-CARBON;1000HM,5%,1/8W,AA,TP,1.8X3.2MM   |        |
| ....4    | EL536    | AA60-40011B EYELET;ID2.2,0D3.2,-,-,BSP,-             | S.N.A  | ....4    | R513     | 2008-001129 R-FUSIBLE(S);1.5ohm,5%,1/2W,AF,TP,2.5x6.  |        |
| ....4    | EL537    | AA60-40011B EYELET;ID2.2,0D3.2,-,-,BSP,-             | S.N.A  | ....4    | R514     | 2001-001122 R-CARBON(S);3.9KOHM,5%,1/2W,AA,TP,2.4X6.  |        |
| ....4    | EL563    | AA60-40011A PIN-GT,ASSY;1P,-,-,AUTO                  | S.N.A  | ....4    | R515     | 2002-001017 R-COMPOSITION;1Kohm,10%,1/2W,AA,TP,3.7x9  |        |
| ....4    | EL564    | AA60-40011B EYELET;ID2.2,0D3.2,-,-,BSP,-             | S.N.A  | ....4    | R516     | 2001-000009 R-CARBON;20KOHM,5%,1/8W,AA,TP,1.8X3.2MM   |        |
| ....4    | EL565    | AA60-40011B EYELET;ID2.2,0D3.2,-,-,BSP,-             | S.N.A  | ....4    | R517     | 2001-000085 R-CARBON(S);100KOHM,5%,1/2W,AA,TP,2.4X6.  |        |
| ....4    | EL566    | AA60-40011B EYELET;ID2.2,0D3.2,-,-,BSP,-             | S.N.A  | ....4    | R518     | 2002-001021 R-COMPOSITION;560KOHM,10%,1/2W,AA,TP,3.7  |        |
| ....4    | EL567    | AA60-40011B EYELET;ID2.2,0D3.2,-,-,BSP,-             | S.N.A  | ....4    | R519     | 2002-001021 R-COMPOSITION;560KOHM,10%,1/2W,AA,TP,3.7  |        |
| ....4    | GT371    | AA60-40014A PIN-GT,ASSY;1P,-,-,AUTO                  | S.N.A  | ....4    | R520     | 2001-000066 R-CARBON(S);10KOHM,5%,1/2W,AA,TP,2.4X6.4  |        |
| ....4    | GT372    | AA60-40014A PIN-GT,ASSY;1P,-,-,AUTO                  | S.N.A  | ....4    | R521     | 2001-001052 R-CARBON(S);1.5MOHM,5%,1/2W,AA,TP,2.4X6.  |        |
| ....4    | GT373    | AA60-40014A PIN-GT,ASSY;1P,-,-,AUTO                  | S.N.A  | ....4    | R522     | 2002-001006 R-COMPOSITION;4.7KOHM,15%,1/2W,AA,TP,3.7  |        |
| ....4    | GT374    | AA60-40014A PIN-GT,ASSY;1P,-,-,AUTO                  | S.N.A  | ....4    | R523     | 2002-001006 R-COMPOSITION;4.7KOHM,15%,1/2W,AA,TP,3.7  |        |
| ....4    | GT501    | AA60-40014A PIN-GT,ASSY;1P,-,-,AUTO                  | S.N.A  | ....4    | R524     | 2001-000028 R-CARBON(S);1000HM,5%,1/2W,AA,TP,2.4X6.4  |        |
| ....4    | GT502    | AA60-40014A PIN-GT,ASSY;1P,-,-,AUTO                  | S.N.A  | ....4    | R526     | 2001-000539 R-CARBON;24KOHM,5%,1/8W,AA,TP,1.8X3.2MM   |        |
| ....4    | GT503    | AA60-40014A PIN-GT,ASSY;1P,-,-,AUTO                  | S.N.A  | ....4    | R527     | 2001-000577 R-CARBON;2KOHM,5%,1/8W,AA,TP,1.8X3.2MM    |        |
| ....4    | GT504    | AA60-40014A PIN-GT,ASSY;1P,-,-,AUTO                  | S.N.A  | ....4    | R528     | 2001-001015 R-CARBON;9.1KOHM,5%,1/8W,AA,TP,1.8X3.2MM  |        |
| ....4    | GT506    | AA60-40014A PIN-GT,ASSY;1P,-,-,AUTO                  | S.N.A  | ....4    | R529     | 2002-001021 R-COMPOSITION;560KOHM,10%,1/2W,AA,TP,3.7  |        |
| ....4    | GT531    | AA60-40014A PIN-GT,ASSY;1P,-,-,AUTO                  | S.N.A  | ....4    | R530     | 2001-000429 R-CARBON;1KOHM,5%,1/8W,AA,TP,1.8X3.2MM    |        |
| ....4    | GT532    | AA60-40014A PIN-GT,ASSY;1P,-,-,AUTO                  | S.N.A  | ....4    | R531     | 2001-000290 R-CARBON;10KOHM,5%,1/8W,AA,TP,1.8X3.2MM   |        |
| ....4    | GT533    | AA60-40014A PIN-GT,ASSY;1P,-,-,AUTO                  | S.N.A  | ....4    | R532     | 2001-000995 R-CARBON;820OHM,5%,1/8W,AA,TP,1.8X3.2MM   |        |
| ....4    | GT534    | AA60-40014A PIN-GT,ASSY;1P,-,-,AUTO                  | S.N.A  | ....4    | R533     | 2001-000429 R-CARBON;1KOHM,5%,1/8W,AA,TP,1.8X3.2MM    |        |
| ....4    | GT535    | AA60-40014A PIN-GT,ASSY;1P,-,-,AUTO                  | S.N.A  | ....4    | R534     | 2001-000563 R-CARBON;27KOHM,5%,1/8W,AA,TP,1.8X3.2MM   |        |
| ....4    | GT536    | AA60-40014A PIN-GT,ASSY;1P,-,-,AUTO                  | S.N.A  | ....4    | R536     | 2001-001049 R-CARBON(S);1.3KOHM,5%,1/2W,AA,TP,2.4X6.  |        |
| ....4    | GT537    | AA60-40014A PIN-GT,ASSY;1P,-,-,AUTO                  | S.N.A  | ....4    | R537     | 2001-001088 R-CARBON(S);1KOHM,5%,1/2W,AA,TP,2.4X6.4M  |        |
| ....4    | GT561    | AA60-40014A PIN-GT,ASSY;1P,-,-,AUTO                  | S.N.A  | ....4    | R538     | 2003-000738 R-METAL OXIDE(S);56Kohm,5%,2W,AA,TP,4x12  |        |
| ....4    | GT562    | AA60-40014A PIN-GT,ASSY;1P,-,-,AUTO                  | S.N.A  | ....4    | R540     | 2001-000908 R-CARBON;62KOHM,5%,1/8W,AA,TP,1.8X3.2MM   |        |
| ....4    | GT563    | AA60-40014A PIN-GT,ASSY;1P,-,-,AUTO                  | S.N.A  | ....4    | R541     | 2001-000009 R-CARBON;20KOHM,5%,1/8W,AA,TP,1.8X3.2MM   |        |
| ....4    | GT564    | AA60-40014A PIN-GT,ASSY;1P,-,-,AUTO                  | S.N.A  | ....4    | R542     | 2001-000890 R-CARBON;6.8KOHM,5%,1/8W,AA,TP,1.8X3.2MM  |        |
| ....4    | GT567    | AA60-40014A PIN-GT,ASSY;1P,-,-,AUTO                  | S.N.A  | ....4    | R543     | 2008-001129 R-FUSIBLE(S);1.5ohm,5%,1/2W,AF,TP,2.5x6.  |        |
| ....4    | GT568    | AA60-40014A PIN-GT,ASSY;1P,-,-,AUTO                  | S.N.A  | ....4    | R544     | 2001-001122 R-CARBON(S);3.9KOHM,5%,1/2W,AA,TP,2.4X6.  |        |
| ....4    | L501     | 2701-000114 INDUCTOR-AXIAL;10uH,10%,2.5x3.4mm        |        | ....4    | R545     | 2002-001017 R-COMPOSITION;1Kohm,10%,1/2W,AA,TP,3.7x9  |        |
| ....4    | L531     | 2701-000114 INDUCTOR-AXIAL;10uH,10%,2.5x3.4mm        |        | ....4    | R546     | 2001-000009 R-CARBON;20KOHM,5%,1/8W,AA,TP,1.8X3.2MM   |        |
| ....4    | L561     | 2701-000168 INDUCTOR-AXIAL;3.3uH,5%,2.5x3.4mm        |        | ....4    | R547     | 2001-000085 R-CARBON(S);100KOHM,5%,1/2W,AA,TP,2.4X6.  |        |
| ....4    | PCB      | AA41-00600A PCB-CRT,FR-1,1L,A,1.6T,245X245,COMMANDO  | S.N.A  | ....4    | R548     | 2002-001021 R-COMPOSITION;560KOHM,10%,1/2W,AA,TP,3.7  |        |
| ....4    | Q361     | 0501-000283 TR-SMALL SIGNAL;KSA539,PNP,400mW,TO-92,T |        | ....4    | R549     | 2002-001021 R-COMPOSITION;560KOHM,10%,1/2W,AA,TP,3.7  |        |
| ....4    | Q362     | 0501-000366 TR-SMALL SIGNAL;KSC2330-Y,NPN,1W,TO-92L, |        | ....4    | R550     | 2001-000066 R-CARBON(S);10KOHM,5%,1/2W,AA,TP,2.4X6.4  |        |
| ....4    | Q501     | 0502-000006 TR-POWER;KSC1507,NPN,15W,TO-220,TP,120-  |        | ....4    | R551     | 2001-001052 R-CARBON(S);1.5MOHM,5%,1/2W,AA,TP,2.4X6.  |        |
| ....4    | Q502     | 0501-000389 TR-SMALL SIGNAL;KSC815,NPN,400mW,TO-92,T |        | ....4    | R552     | 2002-001006 R-COMPOSITION;4.7KOHM,15%,1/2W,AA,TP,3.7  |        |
| ....4    | Q504     | 0501-000283 TR-SMALL SIGNAL;KSA539,PNP,400mW,TO-92,T |        | ....4    | R553     | 2002-001006 R-COMPOSITION;4.7KOHM,15%,1/2W,AA,TP,3.7  |        |
| ....4    | Q531     | 0502-000006 TR-POWER;KSC1507,NPN,15W,TO-220,TP,120-  |        | ....4    | R554     | 2001-000028 R-CARBON(S);1000HM,5%,1/2W,AA,TP,2.4X6.4  |        |
| ....4    | Q533     | 0501-000283 TR-SMALL SIGNAL;KSA539,PNP,400mW,TO-92,T |        | ....4    | R555     | 2001-000734 R-CARBON;4.7KOHM,5%,1/8W,AA,TP,1.8X3.2MM  |        |
| ....4    | Q534     | 0501-000283 TR-SMALL SIGNAL;KSA539,PNP,400mW,TO-92,T |        | ....4    | R556     | 2001-000007 R-CARBON;3KOHM,5%,1/8W,AA,TP,1.8X3.2MM    |        |
| ....4    | Q561     | 0502-000006 TR-POWER;KSC1507,NPN,15W,TO-220,TP,120-  |        | ....4    | R557     | 2001-000362 R-CARBON;1500HM,5%,1/8W,AA,TP,1.8X3.2MM   |        |
| ....4    | Q563     | 0501-000283 TR-SMALL SIGNAL;KSA539,PNP,400mW,TO-92,T |        | ....4    | R558     | 2001-000319 R-CARBON;120KOHM,5%,1/8W,AA,TP,1.8X3.2MM  |        |
| ....4    | R361     | 2001-001097 R-CARBON(S);2.4KOHM,5%,1/2W,AA,TP,2.4X6. |        | ....4    | R559     | 2002-001015 R-COMPOSITION;47Kohm,5%,1/2W,AA,TP,3.7x9  |        |
| ....4    | R362     | 2001-000660 R-CARBON;33KOHM,5%,1/8W,AA,TP,1.8X3.2MM  |        | ....4    | R562     | 2001-000232 R-CARBON;1.3KOHM,5%,1/8W,AA,TP,1.8X3.2MM  |        |
| ....4    | R363     | 2001-000723 R-CARBON;4.3KOHM,5%,1/8W,AA,TP,1.8X3.2MM |        | ....4    | R563     | 2001-000429 R-CARBON;1KOHM,5%,1/8W,AA,TP,1.8X3.2MM    |        |
| ....4    | R364     | 2001-000938 R-CARBON;680HM,5%,1/8W,AA,TP,1.8X3.2MM   |        | ....4    | R564     | 2001-000908 R-CARBON;62KOHM,5%,1/8W,AA,TP,1.8X3.2MM   |        |
| ....4    | R365     | 2001-001120 R-CARBON(S);3.30HM,5%,1/2W,AA,TP,2.4X6.4 |        | ....4    | R566     | 2001-001049 R-CARBON(S);1.3KOHM,5%,1/2W,AA,TP,2.4X6.  |        |
| ....4    | R366     | 2001-000109 R-CARBON(S);4700HM,5%,1/2W,AA,TP,2.4X6.4 |        | ....4    | R567     | 2001-001088 R-CARBON(S);1KOHM,5%,1/2W,AA,TP,2.4X6.4M  |        |
| ....4    | R367     | 2001-001065 R-CARBON(S);110KOHM,5%,1/2W,AA,TP,2.4X6. |        | ....4    | R568     | 2001-000734 R-CARBON;4.7KOHM,5%,1/8W,AA,TP,1.8X3.2MM  |        |
| ....4    | R368     | 2001-001065 R-CARBON(S);110KOHM,5%,1/2W,AA,TP,2.4X6. |        | ....4    | R569     | 2001-000472 R-CARBON;2.7KOHM,5%,1/8W,AA,TP,1.8X3.2MM  |        |
| ....4    | R369     | 2001-001065 R-CARBON(S);110KOHM,5%,1/2W,AA,TP,2.4X6. |        | ....4    | R570     | 2001-000362 R-CARBON;1500HM,5%,1/8W,AA,TP,1.8X3.2MM   |        |
| ....4    | R369A    | 2001-001065 R-CARBON(S);110KOHM,5%,1/2W,AA,TP,2.4X6. |        | ....4    | R571     | 2001-000281 R-CARBON;1000HM,5%,1/8W,AA,TP,1.8X3.2MM   |        |
| ....4    | R370     | 2001-001065 R-CARBON(S);110KOHM,5%,1/2W,AA,TP,2.4X6. |        | ....4    | R573     | 2008-001129 R-FUSIBLE(S);1.5ohm,5%,1/2W,AF,TP,2.5x6.  |        |
| ....4    | R371     | 2001-001065 R-CARBON(S);110KOHM,5%,1/2W,AA,TP,2.4X6. |        | ....4    | R574     | 2001-001122 R-CARBON(S);3.9KOHM,5%,1/2W,AA,TP,2.4X6.  |        |
| ....4    | R372     | 2001-001110 R-CARBON(S);240KOHM,5%,1/2W,AA,TP,2.4X6. |        | ....4    | R575     | 2002-001017 R-COMPOSITION;1Kohm,10%,1/2W,AA,TP,3.7x9  |        |
| ....4    | R373     | 2001-001110 R-CARBON(S);240KOHM,5%,1/2W,AA,TP,2.4X6. |        | ....4    | R576     | 2001-000009 R-CARBON;20KOHM,5%,1/8W,AA,TP,1.8X3.2MM   |        |
| ....4    | R374     | 2001-001110 R-CARBON(S);240KOHM,5%,1/2W,AA,TP,2.4X6. |        | ....4    | R577     | 2001-000085 R-CARBON(S);100KOHM,5%,1/2W,AA,TP,2.4X6.  |        |
| ....4    | R375     | 2001-001113 R-CARBON(S);270KOHM,5%,1/2W,AA,TP,2.4X6. |        | ....4    | R578     | 2002-001021 R-COMPOSITION;560KOHM,10%,1/2W,AA,TP,3.7  |        |
| ....4    | R376     | 2001-000613 R-CARBON;3.9KOHM,5%,1/8W,AA,TP,1.8X3.2MM |        | ....4    | R579     | 2002-001021 R-COMPOSITION;560KOHM,10%,1/2W,AA,TP,3.7  |        |
| ....4    | R377     | 2004-001892 R-METAL(S);162Kohm,1%,1/2W,AA,TP,2.5x6.5 |        | ....4    | R580     | 2001-000066 R-CARBON(S);10KOHM,5%,1/2W,AA,TP,2.4X6.4  |        |
| ....4    | R378     | 2004-001892 R-METAL(S);162Kohm,1%,1/2W,AA,TP,2.5x6.5 |        | ....4    | R581     | 2001-001052 R-CARBON(S);1.5MOHM,5%,1/2W,AA,TP,2.4X6.  |        |
| ....4    | R379     | 2004-001892 R-METAL(S);162Kohm,1%,1/2W,AA,TP,2.5x6.5 |        | ....4    | R582     | 2002-001006 R-COMPOSITION;4.7KOHM,15%,1/2W,AA,TP,3.7  |        |
| ....4    | R380     | 2004-001892 R-METAL(S);162Kohm,1%,1/2W,AA,TP,2.5x6.5 |        | ....4    | R583     | 2002-001006 R-COMPOSITION;4.7KOHM,15%,1/2W,AA,TP,3.7  |        |
| ....4    | R381     | 2001-001088 R-CARBON(S);1KOHM,5%,1/2W,AA,TP,2.4X6.4M |        | ....4    | R584     | 2001-000028 R-CARBON(S);1000HM,5%,1/2W,AA,TP,2.4X6.4  |        |
| ....4    | R382     | 2002-001006 R-COMPOSITION;4.7KOHM,15%,1/2W,AA,TP,3.7 |        | ....4    | R588     | 2003-000738 R-METAL OXIDE(S);56Kohm,5%,2W,AA,TP,4x12  |        |
| ....4    | R500     | 2001-000613 R-CARBON;3.9KOHM,5%,1/8W,AA,TP,1.8X3.2MM |        | ....4    | R589     | 2002-001015 R-COMPOSITION;47Kohm,5%,1/2W,AA,TP,3.7x9  |        |

| Loc. No. | Code No.    | Description ; Specification                          | Remark | Loc. No. | Code No.    | Description ; Specification                          | Remark |
|----------|-------------|--|--------|----------|-------------|--|--------|
| ...4     | SG501       | 4715-001036 SURGE ABSORBER;500V,20%,--,TP            |        | ...4     | RFZ51       | 2008-000261 R-FUSIBLE(S);150ohm,5%,1W,AF,TP,3.9x10mm |        |
| ...4     | SG503       | 4715-001036 SURGE ABSORBER;500V,20%,--,TP            |        | ...4     | RFZ52       | 2008-000261 R-FUSIBLE(S);150ohm,5%,1W,AF,TP,3.9x10mm |        |
| ...4     | SG531       | 4715-001036 SURGE ABSORBER;500V,20%,--,TP            |        | ...4     | RFZ53       | 2008-000261 R-FUSIBLE(S);150ohm,5%,1W,AF,TP,3.9x10mm |        |
| ...4     | SG533       | 4715-001036 SURGE ABSORBER;500V,20%,--,TP            |        | ...4     | RZ104       | 2001-001114 R-CARBON(S);2700HM,5%,1/2W,AA,TP,2.4X6.4 |        |
| ...4     | SG561       | 4715-001036 SURGE ABSORBER;500V,20%,--,TP            |        | ...4     | RZ105       | 2001-001114 R-CARBON(S);2700HM,5%,1/2W,AA,TP,2.4X6.4 |        |
| ...4     | SG563       | 4715-001036 SURGE ABSORBER;500V,20%,--,TP            |        | ...4     | RZ106       | 2001-001114 R-CARBON(S);2700HM,5%,1/2W,AA,TP,2.4X6.4 |        |
| ...3     | BP59-00005A | MODULE-FOCUS PACK ASSY;PJT TV,F301-P03A              |        | ...4     | RZ107       | 2001-001114 R-CARBON(S);2700HM,5%,1/2W,AA,TP,2.4X6.4 |        |
| ...2     | AA95-02002A | ASSY SUB-PCB,CG AMP;COMMANDO                         |        | ...4     | RZ108       | 2001-001114 R-CARBON(S);2700HM,5%,1/2W,AA,TP,2.4X6.4 |        |
| ...3     | CNW01       | BP39-00005A LEAD CONNECTOR ASSY;P55A/HCM4215W,UL2547 |        | ...4     | RZ109       | 2001-001114 R-CARBON(S);2700HM,5%,1/2W,AA,TP,2.4X6.4 |        |
| ...3     | CNW03       | BP39-00015A LEAD CONNECTOR ASSY;P55A/HCM4215W,UL1185 |        | ...4     | RZ110       | 2001-000800 R-CARBON;5.1KOHM,5%,1/8W,AA,TP,1.8X3.2MM |        |
| ...3     | CNZ01       | 3711-003046 CONNECTOR-HEADER;BOX,9P,1R,2.5mm,STRAIGH |        | ...4     | RZ111       | 2001-000563 R-CARBON;27KOHM,5%,1/8W,AA,TP,1.8X3.2MM  |        |
| ...3     | CNZ02       | 3711-003043 CONNECTOR-HEADER;BOX,4P,1R,2.5mm,STRAIGH |        | ...4     | RZ112       | 2001-000563 R-CARBON;27KOHM,5%,1/8W,AA,TP,1.8X3.2MM  |        |
| ...3     | CNZ03       | 3711-003043 CONNECTOR-HEADER;BOX,4P,1R,2.5mm,STRAIGH |        | ...4     | RZ113       | 2001-000591 R-CARBON;3.3KOHM,5%,1/8W,AA,TP,1.8X3.2MM |        |
| ...3     | CNZ04       | 3711-003043 CONNECTOR-HEADER;BOX,4P,1R,2.5mm,STRAIGH |        | ...4     | RZ114       | 2001-000857 R-CARBON;5600HM,5%,1/8W,AA,TP,1.8X3.2MM  |        |
| ...3     | CNZ05       | 3711-003043 CONNECTOR-HEADER;BOX,4P,1R,2.5mm,STRAIGH |        | ...4     | RZ115       | 2001-000591 R-CARBON;3.3KOHM,5%,1/8W,AA,TP,1.8X3.2MM |        |
| ...3     | CZ101       | BP96-00005A ASSY HEAT SINK P;BP62-00002A,SCREW,STK39 | S.N.A  | ...4     | RZ116       | 2001-000857 R-CARBON;5600HM,5%,1/8W,AA,TP,1.8X3.2MM  |        |
| ...4     | CIS         | 1201-001225 IC-VIDEO AMP;392,SIP;22P,-,TRIPLE,-,PLAS |        | ...4     | RZ117       | 2001-000591 R-CARBON;3.3KOHM,5%,1/8W,AA,TP,1.8X3.2MM |        |
| ...4     | CIS         | BP73-00002A SILICON/RUBBER;COMMANDO CG AMP,SILICON   | S.N.A  | ...4     | RZ118       | 2001-000857 R-CARBON;5600HM,5%,1/8W,AA,TP,1.8X3.2MM  |        |
| ...4     | CIS         | BP62-00008A HEAT SINK;COMMANDO CG AMP,AL6063,T2.0,W1 | S.N.A  | ...4     | RZ123       | 2003-002148 R-METAL OXIDE;3.90HM,2%,2W,AF,TP,3.9X10M |        |
| ...4     | CIS         | BP62-00002A HEAT SINK;COMMANDO A1050P,T2.0,W62.0,H14 | S.N.A  | ...4     | RZ124       | 2003-002148 R-METAL OXIDE;3.90HM,2%,2W,AF,TP,3.9X10M |        |
| ...4     | CIS         | 6003-001021 SCREW-TAPTITE;RH,+,B.M3,L15,ZPC(YEL),SWR | S.N.A  | ...4     | RZ125       | 2003-002148 R-METAL OXIDE;3.90HM,2%,2W,AF,TP,3.9X10M |        |
| ...3     | AA65-30110A | CLAMP-WIRE;ALL MODEL,NYLON 66,V2,-,BLK,P             | S.N.A  | ...4     | RZ126       | 2003-002148 R-METAL OXIDE;3.90HM,2%,2W,AF,TP,3.9X10M |        |
| ...3     | BP61-00076A | HOLDER-PUSH,A;42W5,NYLON6.6,NATURAL                  | S.N.A  | ...4     | RZ127       | 2003-002148 R-METAL OXIDE;3.90HM,2%,2W,AF,TP,3.9X10M |        |
| ...3     | BP61-00077A | HOLDER-PUSH,B;42W5,NYLON6.6,NATURAL                  | S.N.A  | ...4     | RZ128       | 2003-002148 R-METAL OXIDE;3.90HM,2%,2W,AF,TP,3.9X10M |        |
| ...3     | 0202-000187 | SOLDER-WIRE FLUX;-RS60S,D1.2.63Sn/37Pb               | S.N.A  | ...4     | RZ129       | 2003-002171 R-METAL OXIDE(S);150ohm,5%,2W,AG,TP,3.9x |        |
| ...3     | AA97-07418A | ASSY AUTO;0000                                       | S.N.A  | ...4     | RZ129A      | 2003-002171 R-METAL OXIDE(S);150ohm,5%,2W,AG,TP,3.9x |        |
| ...4     | C866        | 2401-000183 C-AL;1000uF,20%,35V,WT,TP,12.5x25,5      |        | ...4     | RZ130       | 2003-002171 R-METAL OXIDE(S);150ohm,5%,2W,AG,TP,3.9x |        |
| ...4     | C869        | 2401-000183 C-AL;1000uF,20%,35V,WT,TP,12.5x25,5      |        | ...4     | RZ130A      | 2003-002171 R-METAL OXIDE(S);150ohm,5%,2W,AG,TP,3.9x |        |
| ...4     | CZ108       | 2202-000863 C-CERAMIC,MLC-AXIAL;560pF,10%,50V,Y5P,TP |        | ...4     | RZ131       | 2003-002171 R-METAL OXIDE(S);150ohm,5%,2W,AG,TP,3.9x |        |
| ...4     | CZ109       | 2202-000863 C-CERAMIC,MLC-AXIAL;560pF,10%,50V,Y5P,TP |        | ...4     | RZ131A      | 2003-002171 R-METAL OXIDE(S);150ohm,5%,2W,AG,TP,3.9x |        |
| ...4     | CZ110       | 2202-000863 C-CERAMIC,MLC-AXIAL;560pF,10%,50V,Y5P,TP |        | ...4     | RZ132       | 2003-002171 R-METAL OXIDE(S);150ohm,5%,2W,AG,TP,3.9x |        |
| ...4     | CZ111       | 2202-000205 C-CERAMIC,MLC-AXIAL;22pF,5%,50V,SL,TP,1. |        | ...4     | RZ132A      | 2003-002171 R-METAL OXIDE(S);150ohm,5%,2W,AG,TP,3.9x |        |
| ...4     | CZ112       | 2202-000825 C-CERAMIC,MLC-AXIAL;680pF,10%,50V,Y5P,TP |        | ...4     | RZ133       | 2001-000563 R-CARBON;27KOHM,5%,1/8W,AA,TP,1.8X3.2MM  |        |
| ...4     | CZ113       | 2202-000561 C-CERAMIC,MLC-RADIAL;680pF,5%,50V,NPO,TP |        | ...4     | RZ134       | 2001-000563 R-CARBON;27KOHM,5%,1/8W,AA,TP,1.8X3.2MM  |        |
| ...4     | CZ114       | 2202-000561 C-CERAMIC,MLC-RADIAL;680pF,5%,50V,NPO,TP |        | ...4     | RZ135       | 2001-000563 R-CARBON;27KOHM,5%,1/8W,AA,TP,1.8X3.2MM  |        |
| ...4     | CZ115       | 2202-000205 C-CERAMIC,MLC-AXIAL;22pF,5%,50V,SL,TP,1. |        | ...4     | RZ136       | 2001-000591 R-CARBON;3.3KOHM,5%,1/8W,AA,TP,1.8X3.2MM |        |
| ...4     | CZ116       | 2202-000825 C-CERAMIC,MLC-AXIAL;680pF,10%,50V,Y5P,TP |        | ...4     | RZ137       | 2001-000857 R-CARBON;5600HM,5%,1/8W,AA,TP,1.8X3.2MM  |        |
| ...4     | CZ117       | 2201-000327 C-CERAMIC,DISC;2.2nF,10%,50V,Y5V,TP,6.5x |        | ...4     | RZ138       | 2001-000591 R-CARBON;3.3KOHM,5%,1/8W,AA,TP,1.8X3.2MM |        |
| ...4     | CZ118       | 2201-000327 C-CERAMIC,DISC;2.2nF,10%,50V,Y5V,TP,6.5x |        | ...4     | RZ139       | 2001-000857 R-CARBON;5600HM,5%,1/8W,AA,TP,1.8X3.2MM  |        |
| ...4     | CZ126       | 2202-000863 C-CERAMIC,MLC-AXIAL;560pF,10%,50V,Y5P,TP |        | ...4     | RZ140       | 2001-000591 R-CARBON;3.3KOHM,5%,1/8W,AA,TP,1.8X3.2MM |        |
| ...4     | CZ127       | 2202-000863 C-CERAMIC,MLC-AXIAL;560pF,10%,50V,Y5P,TP |        | ...4     | RZ141       | 2001-000857 R-CARBON;5600HM,5%,1/8W,AA,TP,1.8X3.2MM  |        |
| ...4     | CZ128       | 2202-000863 C-CERAMIC,MLC-AXIAL;560pF,10%,50V,Y5P,TP |        | ...4     | RZ142       | 2003-002148 R-METAL OXIDE;3.90HM,2%,2W,AF,TP,3.9X10M |        |
| ...4     | CZ132       | 2202-000205 C-CERAMIC,MLC-AXIAL;22pF,5%,50V,SL,TP,1. |        | ...4     | RZ143       | 2003-002148 R-METAL OXIDE;3.90HM,2%,2W,AF,TP,3.9X10M |        |
| ...4     | CZ133       | 2202-000825 C-CERAMIC,MLC-AXIAL;680pF,10%,50V,Y5P,TP |        | ...4     | RZ144       | 2003-002148 R-METAL OXIDE;3.90HM,2%,2W,AF,TP,3.9X10M |        |
| ...4     | CZ134       | 2202-000205 C-CERAMIC,MLC-AXIAL;22pF,5%,50V,SL,TP,1. |        | ...4     | RZ145       | 2003-002148 R-METAL OXIDE;3.90HM,2%,2W,AF,TP,3.9X10M |        |
| ...4     | CZ135       | 2202-000825 C-CERAMIC,MLC-AXIAL;680pF,10%,50V,Y5P,TP |        | ...4     | RZ146       | 2003-002148 R-METAL OXIDE;3.90HM,2%,2W,AF,TP,3.9X10M |        |
| ...4     | CZ136       | 2202-000205 C-CERAMIC,MLC-AXIAL;22pF,5%,50V,SL,TP,1. |        | ...4     | RZ147       | 2003-002148 R-METAL OXIDE;3.90HM,2%,2W,AF,TP,3.9X10M |        |
| ...4     | CZ137       | 2202-000825 C-CERAMIC,MLC-AXIAL;680pF,10%,50V,Y5P,TP |        | ...4     | RZ148       | 2003-002171 R-METAL OXIDE(S);150ohm,5%,2W,AG,TP,3.9x |        |
| ...4     | CZ138       | 2201-000327 C-CERAMIC,DISC;2.2nF,10%,50V,Y5V,TP,6.5x |        | ...4     | RZ148A      | 2003-002171 R-METAL OXIDE(S);150ohm,5%,2W,AG,TP,3.9x |        |
| ...4     | CZ139       | 2201-000327 C-CERAMIC,DISC;2.2nF,10%,50V,Y5V,TP,6.5x |        | ...4     | RZ149       | 2003-002171 R-METAL OXIDE(S);150ohm,5%,2W,AG,TP,3.9x |        |
| ...4     | CZ140       | 2401-000962 C-AL;22uF,20%,50V,GP,TP,5x11,5           |        | ...4     | RZ149A      | 2003-002171 R-METAL OXIDE(S);150ohm,5%,2W,AG,TP,3.9x |        |
| ...4     | CZ141       | 2401-000962 C-AL;22uF,20%,50V,GP,TP,5x11,5           |        | △...2    | AA96-00156A | ASSY-POWER,CORD;-EP2/YES(US),H/C100MM,K              | S.N.A  |
| ...4     | CZ151       | 2202-000121 C-CERAMIC,MLC-AXIAL;100pF,10%,50V,Y5P,TP |        | ...3     | 3301-001201 | CORE-FERRITE;AE,21x11x32mm,1500,280G                 |        |
| ...4     | CZ152       | 2202-000121 C-CERAMIC,MLC-AXIAL;100pF,10%,50V,Y5P,TP |        | ...3     | AA61-20284A | HOLDER,P-CORD,PP,-,BLK,VO,KE-002                     | S.N.A  |
| ...4     | CZ153       | 2202-000121 C-CERAMIC,MLC-AXIAL;100pF,10%,50V,Y5P,TP |        | ...3     | AA39-10007Y | POWER-CORD;-EP2/YES,SPT-2 18AWGx2C,2.4m              |        |
| ...4     | CZ154       | 2202-000121 C-CERAMIC,MLC-AXIAL;100pF,10%,50V,Y5P,TP |        | ...3     | 3811-000401 | WIRE-PVC CU;BCWA,300V,ROLL,17/0.16mm,#22             | S.N.A  |
| ...4     | CZ155       | 2202-000121 C-CERAMIC,MLC-AXIAL;100pF,10%,50V,Y5P,TP |        | ...2     | BP94-00153A | ASSY PCB MISC-A/V-FRONT;HCM4216W/XAA,P5              |        |
| ...4     | CZ156       | 2202-000121 C-CERAMIC,MLC-AXIAL;100pF,10%,50V,Y5P,TP |        | ...3     | CNW01A      | BP39-00016A LEAD CONNECTOR ASSY;P55A/HCM4215W,UL2547 |        |
| ...4     | ELZ01       | AA60-40011A EYELET;ID2.0,OD2.8,-,BST,-               | S.N.A  | ...3     | CNW02       | AA39-00260A LEAD CONNECTOR ASSY;UL1007#26,UL/CSA,3P  |        |
| ...4     | ELZ02       | AA60-40011A EYELET;ID2.0,OD2.8,-,BST,-               | S.N.A  | ...3     | CNY01A      | 3711-003601 CONNECTOR-HEADER;BOX,12P,1R,2.5mm,ANGLE  |        |
| ...4     | ELZ03       | AA60-40011A EYELET;ID2.0,OD2.8,-,BST,-               | S.N.A  | ...3     | CNY702      | 3711-000447 CONNECTOR-HEADER;3WALL,3P,1R,2.5mm,ANGLE |        |
| △...4    | FD101S      | 3601-001065 FUSE-AXIAL LEAD;125V,3.5A,FAST-ACTING,CE |        | ...3     | JK101       | 3722-000544 JACK-VHS;4P,11.5mm,AG,BLK,N              |        |
| △...4    | FD102S      | 3601-001065 FUSE-AXIAL LEAD;125V,3.5A,FAST-ACTING,CE |        | ...3     | JK102       | 3722-001164 JACK-PIN;3P,3.4mm,SN,WH;YE,RE,#16-22     |        |
| ...4     | LZ107       | 2701-000142 INDUCTOR-AXIAL;1uH,10%,2.5x3.4mm         |        | ...3     | SW101       | 3404-000208 SWITCH-TACT;12V,50mA,120gf,6x6mm,SPST    |        |
| ...4     | LZ108       | 2701-000142 INDUCTOR-AXIAL;1uH,10%,2.5x3.4mm         |        | ...3     | BP96-00007G | ASSY COVER P-SIDE,JACK;42W5,ABS HB G3676             |        |
| ...4     | LZ109       | 2701-000142 INDUCTOR-AXIAL;1uH,10%,2.5x3.4mm         |        | ...4     | AA61-01128B | HOLDER-SIDE,A/V;43T7,ABS HB,G3676,SVM-11             | S.N.A  |
| ...4     | LZ110       | 2701-000142 INDUCTOR-AXIAL;1uH,10%,2.5x3.4mm         |        | ...4     | AA64-02086E | INLAY-AV;W3,PS SHEET,T0.5,P55A                       | S.N.A  |
| ...4     | LZ111       | 2701-000142 INDUCTOR-AXIAL;1uH,10%,2.5x3.4mm         |        | ...4     | AA64-02780B | DOOR-AV;43T7,ABS HB,G3676,SVM-1132                   |        |
| ...4     | LZ112       | 2701-000142 INDUCTOR-AXIAL;1uH,10%,2.5x3.4mm         |        | ...3     | AA97-07429A | ASSY AUTO;0000                                       | S.N.A  |
| ...4     | PCB         | AA41-00601A PCB-CG AMP;-CEM-1,1L,A,1.6T,245X245,COMM | S.N.A  | ...4     | PCB         | AA41-00499B PCB-FRONT A/V;SVP-54T6SR,FR-1,1L,A,1.6T, | S.N.A  |
| ...4     | R856        | 2001-001155 R-CARBON(S);5.6KOHM,5%,1/2W,AA,TP,2.4X6  |        | ...4     | RK101       | 2001-000006 R-CARBON;2.4KOHM,5%,1/8W,AA,TP,1.8X3.2MM |        |
| ...4     | R857        | 2001-001155 R-CARBON(S);5.6KOHM,5%,1/2W,AA,TP,2.4X6  |        | ...3     | 0202-000187 | SOLDER-WIRE FLUX;-RS60S,D1.2.63Sn/37Pb               | S.N.A  |
| ...4     | RFZ19       | 2008-000261 R-FUSIBLE(S);150ohm,5%,1W,AF,TP,3.9x10mm |        | ...2     | AA94-08574A | ASSY PCB MISC-PWR-DEF;HCM4215W,P55A                  | S.N.A  |
| ...4     | RFZ20       | 2008-000261 R-FUSIBLE(S);150ohm,5%,1W,AF,TP,3.9x10mm |        | ...3     | C432        | 2303-000002 PEF CAPACITOR;8.2nF,5%,400V,TP,19x18X7.7 |        |
| ...4     | RFZ21       | 2008-000261 R-FUSIBLE(S);150ohm,5%,1W,AF,TP,3.9x10mm |        | ...3     | C438        | 2303-000002 PEF CAPACITOR;8.2nF,5%,400V,TP,19x18X7.7 |        |
| ...4     | RFZ22       | 2008-000261 R-FUSIBLE(S);150ohm,5%,1W,AF,TP,3.9x10mm |        | ...3     | C491        | 2306-000322 C-FILM,MPPF;12nF,5%,1.6KV,TP,29x20.5x13, |        |
| ...4     | RFZ50       | 2008-000261 R-FUSIBLE(S);150ohm,5%,1W,AF,TP,3.9x10mm |        | ...3     | C814        | 2301-001041 C-FILM,PPF;15nF,5%,1.6KV,TP,29x14x21.5,2 |        |

Electrical Parts List

| Loc. No. | Code No. | Description ; Specification                              | Remark | Loc. No. | Code No. | Description ; Specification                            | Remark |
|----------|----------|--|--------|----------|----------|--|--------|
| ...      | C815     | 2401-000701 C-AL;2200uF,20%,250V,GP,-,35x70mm,1          |        | △ ...    | PC801S   | 0604-001032 PHOTO-COUPLER;TR,170-260%,300mW,DIP-4,ST   |        |
| ...      | C816     | 2401-000701 C-AL;2200uF,20%,250V,GP,-,35x70mm,1          |        | △ ...    | PC811S   | 0604-001032 PHOTO-COUPLER;TR,170-260%,300mW,DIP-4,ST   |        |
| ...      | C832     | 2306-000323 C-FILM,MPPF;2.2nF,5%,1.6KV,TP,28.5x15.5x     |        | ...      | Q422     | 0505-000156 FET-SILICON;IRF620,N,200V,5A,0.8ohm,50W,   |        |
| ...      | C850     | 2401-003076 C-AL;3300uF,20%,50V,WP,BK,18x35.5mm          |        | ...      | Q423     | 0502-000405 TR-POWER;-NPN,70W,TO-220,BK,10             |        |
| ...      | C852     | 2401-003076 C-AL;3300uF,20%,50V,WP,BK,18x35.5mm          |        | ...      | Q431     | BH99-00033H ASSY HEAT/SINK;BH62-00038A,SPRING,2SC544   | S.N.A  |
| ...      | C856     | 2401-003076 C-AL;3300uF,20%,50V,WP,BK,18x35.5mm          |        | ...      | CIS      | 0502-001230 TR-POWER;FJL6920YDTU,N,20000MMW,TO-264 F   |        |
| ...      | C858     | 2401-000698 C-AL;2200uF,20%,16V,WT,TP,12.5x25.5          |        | ...      | CIS      | 0205-001027 OIL-SILICON;G746,-,-                       | S.N.A  |
| ...      | C863     | 2401-002251 C-AL;470uF,20%,200V,GP,BK,25x40mm,1          |        | ...      | CIS      | BH73-00028A SILICON/RUBBER-HS;CDT ALL,SILICON,26*33*   | S.N.A  |
| ...      | C864     | 2401-000787 C-AL;220uF,20%,160V,GP,TP,16x31.5mm          |        | ...      | CIS      | BH62-00038A HEAT SINK-FBT;TS17JS,A1050S,T2.0,-,-,-     | S.N.A  |
| ...      | C870     | 2401-000142 C-AL;1000uF,20%,16V,WT,TP,10x20.5            |        | ...      | CIS      | BH61-70003A SPRING ETC;CVT4857,STS304-W1/2H,W3.8,-,L   | S.N.A  |
| ...      | CN801    | AA39-00180A LEAD CONNECTOR ASSY;14P;YBNH250-14,3515      |        | ...      | CIS      | 0402-001296 DIODE-RECTIFIER;FMP-3FU,1.5KV,5A,TO-3PF,   |        |
| ...      | CN802    | BP39-00014A LEAD CONNECTOR ASSY;P55A/HCM4215W,UL1007     |        | ...      | Q433     | AA96-00243H ASSY H/S;-POWER,AA62-00045A,KSD73Y,C17A    | S.N.A  |
| ...      | CN803    | 3711-003043 CONNECTOR-HEADER;BOX,4P,1R,2.5mm,STRAIGH     |        | ...      | ...      | 0205-000129 GREASE-SILICON;SC102,JAPAN                 | S.N.A  |
| △ ...    | CR430S   | 2301-001343 C-FILM,MPPF;3.9nF,5%,2kV,TP,29x9.5x16mm,     |        | ...      | ...      | 0502-000298 TR-POWER;KSD73,NPN,30000mW,TO-220,TP,120   |        |
| △ ...    | CR431S   | 2301-001343 C-FILM,MPPF;3.9nF,5%,2kV,TP,29x9.5x16mm,     |        | ...      | ...      | 6003-000335 SCREW-TAPTITE;RH,+2S,M3,L8,ZPC(YEL),SWR    | S.N.A  |
| △ ...    | CR436S   | 2306-000235 C-FILM,MPPF;560nF,5%,400V,TP,26*22.5*14,     |        | ...      | ...      | AA62-00045A HEAT SINK-PS;-,-,T1.0,-,-,DREAM,-,-,-,     | S.N.A  |
| △ ...    | CR471S   | 2301-001091 C-FILM,MPPF;470nF,5%,400V,TP,26x21.5x14.     |        | ...      | Q472     | 0505-000156 FET-SILICON;IRF620,N,200V,5A,0.8ohm,50W,   |        |
| △ ...    | CR473S   | 2306-000322 C-FILM,MPPF;1.2nF,5%,1.6KV,TP,29x20.5x13,    |        | ...      | Q473     | BP96-00006A ASSY HEAT SINK P;BP62-00001A,SCREW,2SC41   | S.N.A  |
| △ ...    | CR474S   | 2306-000326 C-FILM,MPPF;4.7nF,5%,1.6KV,TP,28.5x16x9m     |        | ...      | ...      | BP62-00001A HEAT SINK;COMMANDO,A1050P,T2.0,W62.0,H50   | S.N.A  |
| △ ...    | CX801S   | 2306-000112 C-FILM,MPPF;100nF,20%,250V,BK,-,15mm         |        | ...      | ...      | 6003-000335 SCREW-TAPTITE;RH,+2S,M3,L8,ZPC(YEL),SWR    | S.N.A  |
| △ ...    | CX802S   | 2306-000112 C-FILM,MPPF;100nF,20%,250V,BK,-,15mm         |        | ...      | ...      | 0505-001202 FET-SILICON;IRFS640A,N,200V,9.8A,0.18ohm   |        |
| △ ...    | CY801S   | 2201-000987 C-CERAMIC,DISC;2.2nF,20%,400V,Y5U,TP,12.     |        | ...      | ...      | 0502-001100 TR-POWER;2SC4125,NPN,70W,TO-3PML,BK,8-     |        |
| △ ...    | CY802S   | 2201-000987 C-CERAMIC,DISC;2.2nF,20%,400V,Y5U,TP,12.     |        | ...      | ...      | 0205-000129 GREASE-SILICON;SC102,JAPAN                 | S.N.A  |
| △ ...    | CY803S   | 2201-000963 C-CERAMIC,DISC;1nF,20%,400V,Y5U,TP,9.5x6     |        | ...      | R424     | 2008-000289 R-FUSIBLE(S);1ohm,5%,1W,AA,TP,3.9x10mm     |        |
| △ ...    | CY804S   | 2201-000963 C-CERAMIC,DISC;1nF,20%,400V,Y5U,TP,9.5x6     |        | ...      | R425     | 2003-000417 R-METAL OXIDE(S);1.2Kohm,5%,3W,AA,TP,6x1   |        |
| △ ...    | CY811S   | 2201-000446 C-CERAMIC,DISC;3.3nF,20%,400V,Y5U,TP,15x     |        | ...      | R440     | 2008-000282 R-FUSIBLE;0.47ohm,5%,1W,AA,TP,3.9x12mm     |        |
| △ ...    | CY812S   | 2201-000446 C-CERAMIC,DISC;3.3nF,20%,400V,Y5U,TP,15x     |        | ...      | R831     | 2003-000512 R-METAL OXIDE(S);15Kohm,5%,3W,AA,TP,6x16   |        |
| △ ...    | D431     | 0402-000546 DIODE-RECTIFIER;TVR10G,400V,1.0A,DO-41,T     |        | ...      | R832     | 2003-000512 R-METAL OXIDE(S);15Kohm,5%,3W,AA,TP,6x16   |        |
| △ ...    | D464     | 0402-000236 DIODE-RECTIFIER;GI824,400V,5A,-,TP           |        | △ ...    | T431     | AA26-50001U TRANS-HORIZ.DRIVE;-,-,-,28mH,-,-,105uH-    |        |
| △ ...    | D811S    | AA96-00276A ASSY H/S;-BRIDGE,AA62-00052A,RBV606,WAS      | S.N.A  | △ ...    | T432     | AA26-00053A TRANS;-,-,-,1.2mH,-,-,-,-,-,31.5KHZ,-,-    |        |
| ...      | ...      | AA62-00052A HEAT SINK-PS;-,-,-,SILVER,HOLE 18.5mm, 2     | S.N.A  | △ ...    | T444S    | AA26-00100A TRANS FBT;FA97513L,CT29A7DR,0.3mH,-,-,-    |        |
| ...      | ...      | AA60-30003A WASHER;-,-,-,T1.5,-,-,SBHG-1,-               | S.N.A  | △ ...    | T461     | AA26-50001V TRANS-HORIZ.DRIVE;-,-,-,6.0mH,-,-,-,113uH, |        |
| ...      | ...      | 6003-000335 SCREW-TAPTITE;RH,+2S,M3,L8,ZPC(YEL),SWR      | S.N.A  | △ ...    | T481     | AA26-00091A TRANS-HV-STORAGE;4mH,-,-,14P,8300W,180V,10 |        |
| ...      | ...      | 0402-000549 DIODE-BRIDGE;RBV606,600V,6A,-,BK             |        | △ ...    | T801S    | BP26-00002A TRANS SWITCHING;EER5345,P55A,160V-280V,P   |        |
| ...      | ...      | 0205-000129 GREASE-SILICON;SC102,JAPAN                   |        | △ ...    | TS801S   | BP26-00001A TRANS-POWER S/W (DPMS);19B012,P55A,HCM42   |        |
| △ ...    | D831     | 0402-000250 DIODE-RECTIFIER;RG4C,1000V,1A,-              | S.N.A  | △ ...    | VX801S   | 1405-000187 VARISTOR;750V,1250A,12.5x7mm,TP            |        |
| △ ...    | D855     | AA96-00243E ASSY H/S;-SOUND,AA62-00045A,FMG-G26S         | S.N.A  | ...      | ...      | 0202-000187 SOLDER-WIRE FLUX;-RS60S,D1.2,63Sn/37Pb     | S.N.A  |
| △ ...    | D856     | AA96-00243E ASSY H/S;-SOUND,AA62-00045A,FMG-G26S         | S.N.A  | ...      | ...      | 3301-001201 CORE-FERRITE;AE,21x11x32mm,1500,280G       |        |
| ...      | ...      | 0205-000129 GREASE-SILICON;SC102,JAPAN                   |        | ...      | ...      | BP39-00017A LEAD CONNECTOR;P55A/HCM4215W,UL167#22,U    |        |
| ...      | ...      | 0402-000231 DIODE-RECTIFIER;FMG-G26S,600V,4A,TO-220F     |        | ...      | ...      | 3301-001201 CORE-FERRITE;AE,21x11x32mm,1500,280G       |        |
| ...      | ...      | 6003-000335 SCREW-TAPTITE;RH,+2S,M3,L8,ZPC(YEL),SWR      | S.N.A  | ...      | ...      | AA97-07506Z ASSY AUTO-PWR DEF;HCM4215W                 | S.N.A  |
| ...      | ...      | AA62-00045A HEAT SINK-PS;-,-,T1.0,-,-,DREAM,-,-,-,       | S.N.A  | ...      | C301     | 2305-000427 C-FILM,MPEF;47nF,5%,100V,TP,7.5x12.5x3.5   |        |
| ...      | DZS801   | 0406-001007 DIODE-TVS;PKE180A,171/180/189V,600W,CAS      |        | ...      | C302     | 2201-000292 C-CERAMIC,DISC;1nF,10%,50V,Y5P,TP5x3.5     |        |
| △ ...    | FP801S   | 3601-000300 FUSE-CARTRIDGE;250V,6.3A,SLOW-BLOW,GLASS     |        | ...      | C303     | 2305-000427 C-FILM,MPEF;47nF,5%,100V,TP,7.5x12.5x3.5   |        |
| ...      | GT01     | AA60-40012D PIN-GT,ASSY;PPT1.6,6-12.5-14MM,NYLON66       | S.N.A  | ...      | C304     | 2201-000292 C-CERAMIC,DISC;1nF,10%,50V,Y5P,TP5x3.5     |        |
| ...      | IC301    | AA96-00623A ASSY H/S;-POWER,AA62-00056A,LA7845           | S.N.A  | ...      | C307     | 2401-000365 C-AL;100uF,20%,50V,WT,TP,10x12.5mm,        |        |
| ...      | ...      | 0205-000129 GREASE-SILICON;SC102,JAPAN                   |        | ...      | C308     | 2401-000365 C-AL;100uF,20%,50V,WT,TP,10x12.5mm,        |        |
| ...      | ...      | 1204-000517 IC-VERTICAL DEF;LA7845,SIP,7P,-,PLASTIC      |        | ...      | C309     | 2305-000285 C-FILM,MPEF;220nF,5%,100V,TP,10.5x5.5x15   |        |
| ...      | ...      | 6003-000334 SCREW-TAPTITE;RH,+2S,M3,L6,ZPC(YEL),SWR      | S.N.A  | ...      | C311     | 2305-000149 C-FILM,MPEF;100nF,5%,100V,TP,12x12.5x6.5   |        |
| ...      | ...      | AA62-00056A HEAT SINK-PS;-,-,T1.0,-,-,41*35*70,D2,-,-,   | S.N.A  | ...      | C405     | 2201-000558 C-CERAMIC,DISC;0.47nF,10%,50V,Y5P,TP5x3.5  |        |
| △ ...    | IC421    | AA96-00475B ASSY H/S;SILICON-OIL,FMLG-12S(4),AA62-00     | S.N.A  | ...      | C406     | 2201-000370 C-CERAMIC,DISC;0.22nF,10%,50V,Y5P,TP4x3    |        |
| ...      | ...      | AA62-00066B HEAT SINK;D2,D3,AL,T1.0,89.70,-,AA62-00      | S.N.A  | ...      | C412     | 2301-000383 C-FILM,PEF;10nF,5%,50V,TP,6x7x3.2mm,5mm    |        |
| ...      | ...      | 6003-000334 SCREW-TAPTITE;RH,+2S,M3,L6,ZPC(YEL),SWR      | S.N.A  | ...      | C413     | 2401-000360 C-AL;100uF,20%,50V,GP,TP,8x11.5            |        |
| ...      | ...      | 1203-000165 IC-POSITIVE ADJUST REG.;78R12,TO-220,4P,-,PL |        | ...      | C426     | 2401-000302 C-AL;100uF,20%,25V,GP,TP,6.3x11.5          |        |
| ...      | ...      | 0402-000233 DIODE-RECTIFIER;FML-G12S,200V,5A,-,-         |        | ...      | C427     | 2401-002300 C-AL;47uF,20%,50V,GP,TP,6.3x11.5           |        |
| ...      | ...      | 0205-000129 GREASE-SILICON;SC102,JAPAN                   | S.N.A  | ...      | C428     | 2306-000122 C-FILM,MPPF;100nF,5%,50V,TP,7.3x4.0x5.0m   |        |
| △ ...    | IC430    | 1203-000162 IC-POSITIVE ADJUST REG.;317,TO-220,3P,-,PLAS |        | ...      | C429     | 2305-000704 C-FILM,MPEF;100nF,5%,250V,TP,16.5x10.3x5   |        |
| △ ...    | IC431    | 1201-000191 IC-OP AMP;4558,DIP,8P;300MIL,DUAL,20V/mV     |        | ...      | C437     | 2401-003114 C-AL;4.7uF,20%,250V,WT,TP,10x16.5          |        |
| △ ...    | IC471    | 1203-000610 IC-PWM CONTROLLER;494,DIP,16P;300MIL,PLA     |        | ...      | C445     | 2401-001622 C-AL;6.8uF,20%,50V,BP,TP,16x25mm,7.        |        |
| △ ...    | IC831S   | AA96-00275J ASSY H/S;SCREW,SILICON-OIL,AA62-00051A,S     | S.N.A  | ...      | C449     | 2201-000406 C-CERAMIC,DISC;0.27nF,10%,2kV,Y5P,TP6.3    |        |
| ...      | CIS      | 0205-000129 GREASE-SILICON;SC102,JAPAN                   | S.N.A  | ...      | C450     | 2401-001486 C-AL;47uF,20%,160V,HR,TP,13x20mm,5m        |        |
| ...      | CIS      | 6003-000333 SCREW-TAPTITE;RH,+2S,M3,L10,ZPC(YEL),SW      | S.N.A  | ...      | C451     | 2401-000262 C-AL;100uF,20%,160V,HR,TP,16x25.7,5        |        |
| ...      | CIS      | AA13-00105A IC HYBRID;STR-XG6456,7,-20TO+125,DIP,21A,    |        | ...      | C452     | 2201-000132 C-CERAMIC,DISC;0.1nF,10%,500V,Y5P,TP6.5    |        |
| ...      | CIS      | AA62-00051A HEAT SINK-PS;-,-,-,SILVER,HOLE 31mm,ALL,     | S.N.A  | ...      | C453     | 2401-002288 C-AL;470uF,20%,25V,WT,TP,10x20,5           |        |
| △ ...    | IC851    | 1203-000140 IC-POWER PRESCALER;SE110N,TO-220(SIP),3P     |        | ...      | C454     | 2401-001428 C-AL;470uF,20%,50V,GP,TP,10x20,5           |        |
| ...      | ICS801   | 1203-002177 IC-PWM CONTROLLER;VIPER12ADIP,DIP,8P;300     |        | ...      | C455     | 2201-000132 C-CERAMIC,DISC;0.1nF,10%,500V,Y5P,TP6.5    |        |
| ...      | ICS802   | 1203-001006 IC-VOLTAGE REGULATOR;78R05,TO-220F,4P,-      |        | ...      | C456     | 2401-001527 C-AL;47uF,20%,250V,HR,TP,13x25mm,5m        |        |
| ...      | L432     | AA27-00095A COIL HORIZ. WIDTH;-600uH,YL9N,15x27.5 C      |        | ...      | C457     | 2201-000132 C-CERAMIC,DISC;0.1nF,10%,500V,Y5P,TP6.5    |        |
| ...      | L862     | AA27-10001C COIL-CHOKE;-100uH,K,-,5.0A,ST,700UH-KIR      |        | ...      | C458     | 2401-002288 C-AL;470uF,20%,25V,WT,TP,10x20,5           |        |
| ...      | L863     | AA27-10001C COIL-CHOKE;-100uH,K,-,5.0A,ST,700UH-KIR      |        | ...      | C459     | 2201-000132 C-CERAMIC,DISC;0.1nF,10%,500V,Y5P,TP6.5    |        |
| ...      | L864     | AA27-10002L COIL-CHOKE;-24uH,K,-,2A,-,24UH-K,10x10m      |        | ...      | C460     | 2303-000331 C-FILM,PEF;4.7nF,5%,630V,TP,19.5x12x7.     |        |
| △ ...    | LR401S   | AA27-30003M COIL-LINEARLITY;-5uH,OWA14x15,USRC0.1x6      |        | ...      | C466     | 2401-002619 C-AL;47uF,20%,25V,GP,TP,5x11.5             |        |
| △ ...    | LX801S   | AA29-30002L FILTER-LINE NOISE;-10mHMIN,5A,AC90-260V      |        | ...      | C467     | 2401-000360 C-AL;100uF,20%,50V,GP,TP,8x11.5,5          |        |
| △ ...    | LX802S   | AA29-30002M FILTER-LINE NOISE;-1mHMIN,5A,AC90-260V,      |        | ...      | C468     | 2201-000119 C-CERAMIC,DISC;100nF,+80-20%,50V,Y5V,TP,   |        |
| △ ...    | LX803S   | AA29-30002M FILTER-LINE NOISE;-1mHMIN,5A,AC90-260V,      |        | ...      | C469     | 2201-000180 C-CERAMIC,DISC;10nF,10%,50V,Y5V,TP,7x3,5   |        |
| △ ...    | LX804S   | AA29-30002M FILTER-LINE NOISE;-1mHMIN,5A,AC90-260V,      |        | ...      | C472     | 2401-000262 C-AL;100uF,20%,160V,HR,TP,16x25.7,5        |        |
| △ ...    | NT801S   | 1404-001195 THERMISTOR-NTC;5.1ohm,15%,2900,27mW/C,BK     |        | ...      | C476     | 2401-001989 C-AL;4.7uF,20%,50V,BP,TP,5x11,5            |        |

| Loc. No. | Code No. | Description ; Specification | Remark                                   | Loc. No. | Code No. | Description ; Specification | Remark                                   |       |
|----------|----------|-----------------------------|--|----------|----------|-----------------------------|--|-------|
| ...4     | C477     | 2301-000213                 | C-FILM,PEF;220nF,5%,250V,TP,21.5x11,7.5  | ...4     | DS804    | 0401-000006                 | DIODE-SWITCHING;BAV21,250V,250mA,DO-35,T |       |
| ...4     | C478     | 2301-000020                 | C-FILM,PEF;27nF,5%,100V,TP,7.3x4x12.5mm, | ...4     | DS805    | 0404-001056                 | DIODE-SCHOTTKY;RK16,60V,1.5A,DO-204AC,TP |       |
| ...4     | C479     | 2301-000200                 | C-FILM,PEF;2.2nF,5%,200V,TP,11.0x6.0x9.0 | ...4     | DZ301    | 0403-001327                 | DIODE-ZENER;MTZJ18A,16.22-17.06V,500mW,D |       |
| ...4     | C480     | 2306-000122                 | C-FILM,MPPF;100nF,5%,50V,TP,7.3x4.0x5.0m | ...4     | DZ304    | 0403-001327                 | DIODE-ZENER;MTZJ18A,16.22-17.06V,500mW,D |       |
| ...4     | C481     | 2401-002235                 | C-AL;100uF,20%,16V,GP,TP,5x11mm,5mm      | ...4     | DZ305    | 0403-001329                 | DIODE-ZENER;MTZJ24B,22.61-23.77V,500mW,D |       |
| ...4     | C483     | 2401-000660                 | C-AL;2.2uF,20%,50V,GP,TP,5x11,5          | ...4     | DZ306    | 0403-001330                 | DIODE-ZENER;MTZJ30A,26.99-28.39V,500mW,D |       |
| ...4     | C484     | 2201-000132                 | C-CERAMIC,DISC;0.1nF,10%,500V,Y5P,TP,6.5 | ...4     | DZ307    | 0403-001329                 | DIODE-ZENER;MTZJ24B,22.61-23.77V,500mW,D |       |
| ...4     | C487     | 2305-000178                 | C-FILM,MPEF;10nF,5%,100V,TP,-5mm         | ...4     | DZ386    | 0403-001316                 | DIODE-ZENER;MTZJ3.0A,2.85-3.07V,500mW,DO |       |
| ...4     | C488     | 2401-002144                 | C-AL;47uF,20%,16V,GP,TP,5x11,5           | ...4     | DZ395    | 0403-001319                 | DIODE-ZENER;MTZJ4.7C,4.68-4.93V,500mW,DO |       |
| ...4     | C489     | 2401-001840                 | C-AL;100uF,20%,16V,GP,TP,6.3x11,5        | ...4     | DZ400    | 0403-001325                 | DIODE-ZENER;MTZJ15C,14.35-15.09V,500mW,D |       |
| ...4     | C490     | 2201-000119                 | C-CERAMIC,DISC;100nF,+80-20%,50V,Y5V,TP, | ...4     | DZ413    | 0403-001319                 | DIODE-ZENER;MTZJ4.7C,4.68-4.93V,500mW,DO |       |
| ...4     | C492     | 2401-001026                 | C-AL;3.3uF,20%,50V,GP,TP,5X11,5          | ...4     | DZ473    | 0403-000720                 | DIODE-ZENER;MTZJ9.1B,9.1V,8.57-9.01V,500 |       |
| ...4     | C811     | 2201-000332                 | C-CERAMIC,DISC;2.2nF,20%,250V,Y5U,TP,9x4 | ...4     | DZ474    | 0403-000734                 | DIODE-ZENER;TZP15B,15V,14.7-16.5V,1W,DO- |       |
| ...4     | C812     | 2201-000332                 | C-CERAMIC,DISC;2.2nF,20%,250V,Y5U,TP,9x4 | ...4     | DZ481    | 0403-001327                 | DIODE-ZENER;MTZJ18A,16.22-17.06V,500mW,D |       |
| ...4     | C813     | 2201-000332                 | C-CERAMIC,DISC;2.2nF,20%,250V,Y5U,TP,9x4 | △ ...4   | DZ482S   | 0403-000720                 | DIODE-ZENER;MTZJ9.1B,9.1V,8.57-9.01V,500 |       |
| ...4     | C831     | 2301-001216                 | C-FILM,PPF;47nF,5%,630V,TP,20x14.5x22.7, | ...4     | DZ483    | 0403-000720                 | DIODE-ZENER;MTZJ9.1B,9.1V,8.57-9.01V,500 |       |
| ...4     | C833     | 2201-000292                 | C-CERAMIC,DISC;1nF,10%,50V,Y5P,TP,5x3.5, | ...4     | DZ804    | 0403-001167                 | DIODE-ZENER;MTZJ30D,30V,29.02-30.51V,500 |       |
| ...4     | C834     | 2401-001625                 | C-AL;6.8uF,20%,50V,GP,TP,5x11,5          | ...4     | DZ831    | 0403-000716                 | DIODE-ZENER;MTZJ4.7B,4.7V,4.55-4.8V,500m |       |
| ...4     | C835     | 2401-002144                 | C-AL;47uF,20%,16V,GP,TP,5x11,5           | ...4     | DZ851    | 0403-001325                 | DIODE-ZENER;MTZJ15C,14.35-15.09V,500mW,D |       |
| ...4     | C837     | 2201-000138                 | C-CERAMIC,DISC;100pF,10%,50V,Y5P,TP,4.0X | ...4     | DZS802   | 0403-000704                 | DIODE-ZENER;TZP7.5B,7.5V,7.5-8.4V,1W,DO- |       |
| ...4     | C838     | 2305-000412                 | C-FILM,MPEF;470nF,5%,63V,TP,-5mm         | ...4     | DZS803   | 0403-001328                 | DIODE-ZENER;MTZJ22A,20.15-21.20V,500mW,D |       |
| ...4     | C849     | 2401-002216                 | C-AL;2200uF,20%,35V,GP,TP,16x25,7.5      | ...4     | DZS804   | 0403-001330                 | DIODE-ZENER;MTZJ30A,26.99-28.39V,500mW,D |       |
| ...4     | C851     | 2201-000551                 | C-CERAMIC,DISC;0.47nF,10%,1kV,Y5P,TP,6.3 | ...4     | ELO1     | AA60-40011B                 | EYELET;ID2.2,OD3.2,-,BSP-                | S.N.A |
| ...4     | C853     | 2201-000551                 | C-CERAMIC,DISC;0.47nF,10%,1kV,Y5P,TP,6.3 | ...4     | ELO2     | AA60-40011B                 | EYELET;ID2.2,OD3.2,-,BSP-                | S.N.A |
| ...4     | C854     | 2401-002216                 | C-AL;2200uF,20%,35V,GP,TP,16x25,7.5      | ...4     | ELO3     | AA60-40011B                 | EYELET;ID2.2,OD3.2,-,BSP-                | S.N.A |
| ...4     | C855     | 2201-000551                 | C-CERAMIC,DISC;0.47nF,10%,1kV,Y5P,TP,6.3 | ...4     | ELO4     | AA60-40011B                 | EYELET;ID2.2,OD3.2,-,BSP-                | S.N.A |
| ...4     | C857     | 2201-000551                 | C-CERAMIC,DISC;0.47nF,10%,1kV,Y5P,TP,6.3 | ...4     | ELO5     | AA60-40011B                 | EYELET;ID2.2,OD3.2,-,BSP-                | S.N.A |
| ...4     | C859     | 2201-000551                 | C-CERAMIC,DISC;0.47nF,10%,1kV,Y5P,TP,6.3 | ...4     | ELO6     | AA60-40011B                 | EYELET;ID2.2,OD3.2,-,BSP-                | S.N.A |
| ...4     | C860     | 2401-000703                 | C-AL;2200uF,20%,25V,GP,-,12.5x25mm,      | ...4     | ELO7     | AA60-40011B                 | EYELET;ID2.2,OD3.2,-,BSP-                | S.N.A |
| ...4     | C861     | 2401-000603                 | C-AL;1uF,20%,50V,GP,TP,5x11,5            | ...4     | ELO8     | AA60-40011B                 | EYELET;ID2.2,OD3.2,-,BSP-                | S.N.A |
| ...4     | C862     | 2201-000551                 | C-CERAMIC,DISC;0.47nF,10%,1kV,Y5P,TP,6.3 | ...4     | EL10     | AA60-40011B                 | EYELET;ID2.2,OD3.2,-,BSP-                | S.N.A |
| ...4     | C865     | 2305-000427                 | C-FILM,MPEF;47nF,5%,100V,TP,7.5x12.5x3.5 | ...4     | EL11     | AA60-40011B                 | EYELET;ID2.2,OD3.2,-,BSP-                | S.N.A |
| ...4     | C866     | 2401-001397                 | C-AL;470uF,20%,25V,GP,TP,10x16,5         | ...4     | EL12     | AA60-40011B                 | EYELET;ID2.2,OD3.2,-,BSP-                | S.N.A |
| ...4     | C867     | 2201-000180                 | C-CERAMIC,DISC;10nF,10%,50V,Y5V,TP,7x3.5 | ...4     | EL13     | AA60-40011B                 | EYELET;ID2.2,OD3.2,-,BSP-                | S.N.A |
| ...4     | C868     | 2401-000302                 | C-AL;100uF,20%,25V,GP,TP,6.3x11,5        | ...4     | EL14     | AA60-40011B                 | EYELET;ID2.2,OD3.2,-,BSP-                | S.N.A |
| ...4     | C869     | 2401-000164                 | C-AL;1000uF,20%,25V,WT,TP,12.5x20,5      | ...4     | EL15     | AA60-40011B                 | EYELET;ID2.2,OD3.2,-,BSP-                | S.N.A |
| ...4     | C871     | 2305-000289                 | C-FILM,MPEF;220nF,5%,63V,TP,-5mm         | ...4     | EL16     | AA60-40011B                 | EYELET;ID2.2,OD3.2,-,BSP-                | S.N.A |
| ...4     | CN401    | 3711-002645                 | CONNECTOR-HEADER;BOX,6P,1R,2.5mm,STRAIGH | ...4     | EY01     | AA60-40011A                 | EYELET;ID2.0,OD2.8,-,BST-                | S.N.A |
| △ ...4   | CR401S   | 2401-001026                 | C-AL;3.3uF,20%,50V,GP,TP,5X11,5          | ...4     | EY02     | AA60-40011A                 | EYELET;ID2.0,OD2.8,-,BST-                | S.N.A |
| △ ...4   | CR402S   | 2201-000146                 | C-CERAMIC,DISC;0.1nF,5%,50V,SL,TP,5x3.5, | ...4     | EY03     | AA60-40011A                 | EYELET;ID2.0,OD2.8,-,BST-                | S.N.A |
| △ ...4   | CR403S   | 2201-000146                 | C-CERAMIC,DISC;0.1nF,5%,50V,SL,TP,5x3.5, | ...4     | EY04     | AA60-40011A                 | EYELET;ID2.0,OD2.8,-,BST-                | S.N.A |
| ...4     | CS801    | 2301-000356                 | C-FILM,PEF;47nF,5%,50V,TP,7.5x4.0x6.5,5m | ...4     | EY05     | AA60-40011A                 | EYELET;ID2.0,OD2.8,-,BST-                | S.N.A |
| ...4     | CS802    | 2401-000480                 | C-AL;100uF,20%,50V,GP,TP,5x11,5          | ...4     | EY06     | AA60-40011A                 | EYELET;ID2.0,OD2.8,-,BST-                | S.N.A |
| ...4     | CS803    | 2401-001192                 | C-AL;33uF,20%,50V,GP,TP,6.3x11,5         | ...4     | EY07     | AA60-40011A                 | EYELET;ID2.0,OD2.8,-,BST-                | S.N.A |
| ...4     | CS804    | 2201-000119                 | C-CERAMIC,DISC;100nF,+80-20%,50V,Y5V,TP, | ...4     | EY08     | AA60-40011A                 | EYELET;ID2.0,OD2.8,-,BST-                | S.N.A |
| ...4     | CS807    | 2401-001655                 | C-AL;680uF,20%,25V,GP,TP,10x20,5         | ...4     | EY09     | AA60-40011A                 | EYELET;ID2.0,OD2.8,-,BST-                | S.N.A |
| ...4     | CS808    | 2401-002463                 | C-AL;470uF,20%,16V,GP,TP,8x11.5,5        | ...4     | EY10     | AA60-40011A                 | EYELET;ID2.0,OD2.8,-,BST-                | S.N.A |
| ...4     | CS809    | 2201-000119                 | C-CERAMIC,DISC;100nF,+80-20%,50V,Y5V,TP, | ...4     | EY100    | AA60-40011A                 | EYELET;ID2.0,OD2.8,-,BST-                | S.N.A |
| ...4     | D301     | 0401-000005                 | DIODE-SWITCHING;1N4148,100V,200mA,DO-35, | ...4     | EY101    | AA60-40011A                 | EYELET;ID2.0,OD2.8,-,BST-                | S.N.A |
| ...4     | D302     | 0402-000546                 | DIODE-RECTIFIER;TVR10G,400V,1.0A,DO-41,T | ...4     | EY102    | AA60-40011A                 | EYELET;ID2.0,OD2.8,-,BST-                | S.N.A |
| ...4     | D384     | 0402-000132                 | DIODE-RECTIFIER;1N4004,400V,1A,DO-41,TP  | ...4     | EY103    | AA60-40011A                 | EYELET;ID2.0,OD2.8,-,BST-                | S.N.A |
| ...4     | D385     | 0401-000005                 | DIODE-SWITCHING;1N4148,100V,200mA,DO-35, | ...4     | EY104    | AA60-40011A                 | EYELET;ID2.0,OD2.8,-,BST-                | S.N.A |
| ...4     | D433     | 0402-000537                 | DIODE-RECTIFIER;RH1A,600V,0.6A,DO-204AC  | ...4     | EY105    | AA60-40011A                 | EYELET;ID2.0,OD2.8,-,BST-                | S.N.A |
| ...4     | D435     | 0402-000132                 | DIODE-RECTIFIER;1N4004,400V,1A,DO-41,TP  | ...4     | EY106    | AA60-40011A                 | EYELET;ID2.0,OD2.8,-,BST-                | S.N.A |
| ...4     | D436     | 0401-000005                 | DIODE-SWITCHING;1N4148,100V,200mA,DO-35, | ...4     | EY107    | AA60-40011A                 | EYELET;ID2.0,OD2.8,-,BST-                | S.N.A |
| ...4     | D440     | 0402-000534                 | DIODE-RECTIFIER;RG10V,400V,1.2A,DO-201,T | ...4     | EY108    | AA60-40011A                 | EYELET;ID2.0,OD2.8,-,BST-                | S.N.A |
| ...4     | D441     | 0402-000534                 | DIODE-RECTIFIER;RG10V,400V,1.2A,DO-201,T | ...4     | EY109    | AA60-40011A                 | EYELET;ID2.0,OD2.8,-,BST-                | S.N.A |
| ...4     | D442     | 0401-000005                 | DIODE-SWITCHING;1N4148,100V,200mA,DO-35, | ...4     | EY11     | AA60-40011A                 | EYELET;ID2.0,OD2.8,-,BST-                | S.N.A |
| ...4     | D443     | 0401-000005                 | DIODE-SWITCHING;1N4148,100V,200mA,DO-35, | ...4     | EY111    | AA60-40011A                 | EYELET;ID2.0,OD2.8,-,BST-                | S.N.A |
| ...4     | D445     | 0402-000534                 | DIODE-RECTIFIER;RG10V,400V,1.2A,DO-201,T | ...4     | EY113    | AA60-40011A                 | EYELET;ID2.0,OD2.8,-,BST-                | S.N.A |
| ...4     | D451     | 0402-000534                 | DIODE-RECTIFIER;RG10V,400V,1.2A,DO-201,T | ...4     | EY114    | AA60-40011A                 | EYELET;ID2.0,OD2.8,-,BST-                | S.N.A |
| ...4     | D453     | 0402-001286                 | DIODE-RECTIFIER;RP1H,2000V,1A,-,TP       | ...4     | EY115    | AA60-40011A                 | EYELET;ID2.0,OD2.8,-,BST-                | S.N.A |
| ...4     | D472     | 0402-000546                 | DIODE-RECTIFIER;TVR10G,400V,1.0A,DO-41,T | ...4     | EY116    | AA60-40011A                 | EYELET;ID2.0,OD2.8,-,BST-                | S.N.A |
| ...4     | D474     | 0402-000546                 | DIODE-RECTIFIER;TVR10G,400V,1.0A,DO-41,T | ...4     | EY117    | AA60-40011A                 | EYELET;ID2.0,OD2.8,-,BST-                | S.N.A |
| ...4     | D477     | 0401-000005                 | DIODE-SWITCHING;1N4148,100V,200mA,DO-35, | ...4     | EY118    | AA60-40011A                 | EYELET;ID2.0,OD2.8,-,BST-                | S.N.A |
| ...4     | D478     | 0401-000005                 | DIODE-SWITCHING;1N4148,100V,200mA,DO-35, | ...4     | EY119    | AA60-40011A                 | EYELET;ID2.0,OD2.8,-,BST-                | S.N.A |
| ...4     | D479     | 0401-000005                 | DIODE-SWITCHING;1N4148,100V,200mA,DO-35, | ...4     | EY12     | AA60-40011A                 | EYELET;ID2.0,OD2.8,-,BST-                | S.N.A |
| ...4     | D480     | 0402-000132                 | DIODE-RECTIFIER;1N4004,400V,1A,DO-41,TP  | ...4     | EY120    | AA60-40011A                 | EYELET;ID2.0,OD2.8,-,BST-                | S.N.A |
| ...4     | D484     | 0402-000132                 | DIODE-RECTIFIER;1N4004,400V,1A,DO-41,TP  | ...4     | EY121    | AA60-40011A                 | EYELET;ID2.0,OD2.8,-,BST-                | S.N.A |
| △ ...4   | D501     | 0402-000132                 | DIODE-RECTIFIER;1N4004,400V,1A,DO-41,TP  | ...4     | EY122    | AA60-40011A                 | EYELET;ID2.0,OD2.8,-,BST-                | S.N.A |
| △ ...4   | D843     | 0402-000546                 | DIODE-RECTIFIER;TVR10G,400V,1.0A,DO-41,T | ...4     | EY123    | AA60-40011A                 | EYELET;ID2.0,OD2.8,-,BST-                | S.N.A |
| △ ...4   | D857     | 0402-000132                 | DIODE-RECTIFIER;1N4004,400V,1A,DO-41,TP  | ...4     | EY124    | AA60-40011A                 | EYELET;ID2.0,OD2.8,-,BST-                | S.N.A |
| △ ...4   | DR401S   | 0401-000005                 | DIODE-SWITCHING;1N4148,100V,200mA,DO-35, | ...4     | EY125    | AA60-40011A                 | EYELET;ID2.0,OD2.8,-,BST-                | S.N.A |
| △ ...4   | DR402S   | 0401-000005                 | DIODE-SWITCHING;1N4148,100V,200mA,DO-35, | ...4     | EY126    | AA60-40011A                 | EYELET;ID2.0,OD2.8,-,BST-                | S.N.A |
| △ ...4   | DR404S   | 0403-001325                 | DIODE-ZENER;MTZJ15C,14.35-15.09V,500mW,D | ...4     | EY127    | AA60-40011A                 | EYELET;ID2.0,OD2.8,-,BST-                | S.N.A |
| ...4     | DS801    | 0402-000254                 | DIODE-RECTIFIER;RGP10J,600V,1A,DO-41,TP  | ...4     | EY128    | AA60-40011A                 | EYELET;ID2.0,OD2.8,-,BST-                | S.N.A |
| ...4     | DS802    | 0401-000006                 | DIODE-SWITCHING;BAV21,250V,250mA,DO-35,T | ...4     | EY129    | AA60-40011A                 | EYELET;ID2.0,OD2.8,-,BST-                | S.N.A |



| Loc. No. | Code No. | Description ; Specification | Remark                                   | Loc. No. | Code No.     | Description ; Specification             | Remark                                      |
|----------|----------|-----------------------------|--|----------|--------------|---|---|
| ...4     | Q401     | 0501-000389                 | TR-SMALL SIGNAL;KSC815,NPN,400mW,TO-92,T | ...4     | R460         | 2003-002044                             | R-METAL OXIDE(S);100ohm,5%,1W,AF,TP,2.5x    |
| ...4     | Q402     | 0501-000389                 | TR-SMALL SIGNAL;KSC815,NPN,400mW,TO-92,T | ...4     | R461         | 2001-000613                             | R-CARBON;3.9KOHM,5%,1/8W,AA,TP,1.8X3.2MM    |
| ...4     | Q421     | 0501-000389                 | TR-SMALL SIGNAL;KSC815,NPN,400mW,TO-92,T | ...4     | R462         | 2008-001145                             | R-FUSIBLE;4.70HM,5%,1/2W,AF,TP,2.5X6.5MM    |
| ...4     | Q432     | 0501-000283                 | TR-SMALL SIGNAL;KSA539,PNP,400mW,TO-92,T | ...4     | R463         | 2003-001024                             | R-METAL OXIDE(S);150ohm,5%,2W,AF,TP,3.9x    |
| ...4     | Q451     | 0501-000389                 | TR-SMALL SIGNAL;KSC815,NPN,400mW,TO-92,T | ...4     | R464         | 2003-002158                             | R-METAL OXIDE;0.68OHM,5%,1W,AG,TP,4.3X12    |
| ...4     | Q461     | 0501-000389                 | TR-SMALL SIGNAL;KSC815,NPN,400mW,TO-92,T | ...4     | R465         | 2008-000253                             | R-FUSIBLE(S);0.47ohm,5%,1W,AF,TP,3.9x10m    |
| ...4     | Q471     | 0501-000389                 | TR-SMALL SIGNAL;KSC815,NPN,400mW,TO-92,T | ...4     | R466         | 2004-001386                             | R-METAL(S);16.9Kohm,1%,1/2W,AA,TP,2.4x6     |
| ...4     | Q474     | 0501-000389                 | TR-SMALL SIGNAL;KSC815,NPN,400mW,TO-92,T | ...4     | R467         | 2004-001986                             | R-METAL(S);35.7Kohm,1%,1/2W,AA,TP,2.4x6     |
| ...4     | Q481     | 0501-000389                 | TR-SMALL SIGNAL;KSC815,NPN,400mW,TO-92,T | ...4     | R468         | 2001-001122                             | R-CARBON(S);3.9KOHM,5%,1/2W,AA,TP,2.4X6     |
| ...4     | Q482     | 0501-000283                 | TR-SMALL SIGNAL;KSA539,PNP,400mW,TO-92,T | ...4     | R470         | 2001-000028                             | R-CARBON(S);100OHM,5%,1/2W,AA,TP,2.4X6.4    |
| ...4     | Q851     | 0501-000389                 | TR-SMALL SIGNAL;KSC815,NPN,400mW,TO-92,T | ...4     | R471         | 2004-002011                             | R-METAL(S);110Kohm,1%,1/2W,AA,TP,2.4x6.4    |
| △        | QR401S   | 0501-000283                 | TR-SMALL SIGNAL;KSA539,PNP,400mW,TO-92,T | ...4     | R472         | 2008-000252                             | R-FUSIBLE(S);0.47ohm,10%,1/2W,AF,TP,2.5x    |
| ...4     | QS801    | 0501-000389                 | TR-SMALL SIGNAL;KSC815,NPN,400mW,TO-92,T | ...4     | R473         | 2004-001395                             | R-METAL(S);330Kohm,2%,1/2W,AA,TP,2.4x6.4    |
| ...4     | QS802    | 0501-000389                 | TR-SMALL SIGNAL;KSC815,NPN,400mW,TO-92,T | ...4     | R474         | 2001-000009                             | R-CARBON;20KOHM,5%,1/8W,AA,TP,1.8X3.2MM     |
| ...4     | R301     | 2004-001897                 | R-METAL(S);43.2Kohm,1%,1/2W,AA,TP,2.5x6  | ...4     | R475         | 2001-000812                             | R-CARBON;5.6KOHM,5%,1/8W,AA,TP,1.8X3.2MM    |
| ...4     | R302     | 2004-001897                 | R-METAL(S);43.2Kohm,1%,1/2W,AA,TP,2.5x6  | ...4     | R482         | 2001-001031                             | R-CARBON;91KOHM,5%,1/8W,AA,TP,1.8X3.2MM     |
| ...4     | R303     | 2004-001984                 | R-METAL(S);26.7Kohm,1%,1/2W,AA,TP,2.4x6  | ...4     | R483         | 2001-000429                             | R-CARBON;1KOHM,5%,1/8W,AA,TP,1.8X3.2MM      |
| ...4     | R305     | 2004-001984                 | R-METAL(S);26.7Kohm,1%,1/2W,AA,TP,2.4x6  | ...4     | R484         | 2001-000429                             | R-CARBON;1KOHM,5%,1/8W,AA,TP,1.8X3.2MM      |
| ...4     | R306     | 2008-001076                 | R-FUSIBLE(S);1.8ohm,5%,2W,AF,TP,3.9x10mm | ...4     | R485         | 2008-001137                             | R-FUSIBLE(S);3.3ohm,5%,1W,AF,TP,3.9x10mm    |
| ...4     | R307     | 2008-000290                 | R-FUSIBLE(S);2.4ohm,5%,2W,AF,TP,3.9x10mm | ...4     | R486         | 2008-001018                             | R-FUSIBLE(S);0.47ohm,10%,1/2W,AA,TP,2.4x6.4 |
| ...4     | R308     | 2001-000016                 | R-CARBON(S);1OHM,5%,1/2W,AA,TP,2.4X6.4MM | ...4     | R487         | 2001-000924                             | R-CARBON;680OHM,5%,1/8W,AA,TP,1.8X3.2MM     |
| ...4     | R310     | 2003-001024                 | R-METAL OXIDE(S);150ohm,5%,2W,AF,TP,3.9x | ...4     | R488         | 2001-000273                             | R-CARBON;100KOHM,5%,1/8W,AA,TP,1.8X3.2MM    |
| ...4     | R312     | 2001-000290                 | R-CARBON;10KOHM,5%,1/8W,AA,TP,1.8X3.2MM  | ...4     | R489         | 2001-000800                             | R-CARBON;5.1KOHM,5%,1/8W,AA,TP,1.8X3.2MM    |
| ...4     | R313     | 2001-000761                 | R-CARBON;4300HM,5%,1/8W,AA,TP,1.8X3.2MM  | ...4     | R490         | 2001-000800                             | R-CARBON;5.1KOHM,5%,1/8W,AA,TP,1.8X3.2MM    |
| ...4     | R314     | 2001-000761                 | R-CARBON;4300HM,5%,1/8W,AA,TP,1.8X3.2MM  | ...4     | R491         | 2001-000745                             | R-CARBON;4.70HM,5%,1/8W,AA,TP,1.8X3.2MM     |
| ...4     | R384     | 2001-001150                 | R-CARBON(S);470KOHM,5%,1/2W,AA,TP,2.4X6  | ...4     | R492         | 2001-000508                             | R-CARBON;220KOHM,5%,1/8W,AA,TP,1.8X3.2MM    |
| ...4     | R385     | 2001-000577                 | R-CARBON;2KOHM,5%,1/8W,AA,TP,1.8X3.2MM   | ...4     | R494         | 2001-000734                             | R-CARBON;4.7KOHM,5%,1/8W,AA,TP,1.8X3.2MM    |
| ...4     | R386     | 2001-000786                 | R-CARBON;47KOHM,5%,1/8W,AA,TP,1.8X3.2MM  | ...4     | R495         | 2001-000262                             | R-CARBON;1.8MOHM,5%,1/8W,AA,TP,1.8X3.2MM    |
| ...4     | R387     | 2001-000009                 | R-CARBON;20KOHM,5%,1/8W,AA,TP,1.8X3.2MM  | ...4     | R501         | 2004-001376                             | R-METAL(S);11Kohm,1%,1/2W,AA,TP,2.4x6.4m    |
| ...4     | R388     | 2001-000522                 | R-CARBON;22KOHM,5%,1/8W,AA,TP,1.8X3.2MM  | ...4     | R502         | 2004-001369                             | R-METAL(S);1.2Kohm,1%,1/2W,AA,TP,2.4x6.4    |
| ...4     | R389     | 2001-000577                 | R-CARBON;2KOHM,5%,1/8W,AA,TP,1.8X3.2MM   | ...4     | R801         | 2003-002020                             | R-METAL OXIDE(S);56Kohm,5%,2W,AF,TP,3.9x    |
| ...4     | R397     | 2001-000554                 | R-CARBON;270OHM,5%,1/8W,AA,TP,1.8X3.2MM  | ...4     | R811         | 2001-000085                             | R-CARBON(S);100KOHM,5%,1/2W,AA,TP,2.4X6     |
| ...4     | R405     | 2009-001109                 | R-TEMPERATURE;240ohm,5%,1/4W,AA,TP,2.3x6 | ...4     | R812         | 2001-000085                             | R-CARBON(S);100KOHM,5%,1/2W,AA,TP,2.4X6     |
| ...4     | R406     | 2004-001402                 | R-METAL(S);6.8Kohm,1%,1/2W,AA,TP,2.4x6.4 | ...4     | R813         | 2001-000085                             | R-CARBON(S);100KOHM,5%,1/2W,AA,TP,2.4X6     |
| ...4     | R407     | 2004-001408                 | R-METAL(S);91Kohm,1%,1/2W,AA,TP,2.4x6.4m | ...4     | R814         | 2001-000085                             | R-CARBON(S);100KOHM,5%,1/2W,AA,TP,2.4X6     |
| ...4     | R408     | 2004-001893                 | R-METAL(S);22Kohm,1%,1/2W,AA,TP,2.5x6.5m | ...4     | R833         | 2009-000017                             | R-METAL PLATE;0.1ohm,10%,5W,CL,TP,5x14x1    |
| ...4     | R409     | 2004-001983                 | R-METAL(S);2.49Kohm,1%,1/2W,AA,TP,2.4x6  | ...4     | R834         | 2001-000109                             | R-CARBON(S);4700HM,5%,1/2W,AA,TP,2.4X6.4    |
| ...4     | R410     | 2001-001155                 | R-CARBON(S);5.6KOHM,5%,1/2W,AA,TP,2.4X6  | ...4     | R836         | 2001-000052                             | R-CARBON(S);3.3KOHM,5%,1/2W,AA,TP,2.4X6     |
| ...4     | R412     | 2001-000362                 | R-CARBON;1500HM,5%,1/8W,AA,TP,1.8X3.2MM  | ...4     | R837         | 2001-001108                             | R-CARBON(S);22KOHM,5%,1/2W,AA,TP,2.4X6.4    |
| ...4     | R413     | 2001-001088                 | R-CARBON(S);1KOHM,5%,1/2W,AA,TP,2.4X6.4M | ...4     | R838         | 2008-001053                             | R-FUSIBLE;22ohm,5%,1/2W,AF,TP,2.5x6.5mm     |
| ...4     | R414     | 2001-000734                 | R-CARBON;4.7KOHM,5%,1/8W,AA,TP,1.8X3.2MM | ...4     | R839         | 2001-001088                             | R-CARBON(S);1KOHM,5%,1/2W,AA,TP,2.4X6.4M    |
| ...4     | R415     | 2001-000734                 | R-CARBON;4.7KOHM,5%,1/8W,AA,TP,1.8X3.2MM | ...4     | R851         | 2001-001196                             | R-CARBON(S);9.1KOHM,5%,1/2W,AA,TP,2.4X6     |
| ...4     | R416     | 2001-000006                 | R-CARBON;2.4KOHM,5%,1/8W,AA,TP,1.8X3.2MM | ...4     | R852         | 2001-000290                             | R-CARBON;10KOHM,5%,1/8W,AA,TP,1.8X3.2MM     |
| ...4     | R417     | 2001-000515                 | R-CARBON;220OHM,5%,1/8W,AA,TP,1.8X3.2MM  | ...4     | R853         | 2004-004366                             | R-METAL(S);1.3Kohm,1%,1/2W,AA,TP,2.5x6.5    |
| ...4     | R418     | 2001-000290                 | R-CARBON;10KOHM,5%,1/8W,AA,TP,1.8X3.2MM  | ...4     | R854         | 2001-001088                             | R-CARBON(S);1KOHM,5%,1/2W,AA,TP,2.4X6.4M    |
| ...4     | R420     | 2001-000281                 | R-CARBON;1000HM,5%,1/8W,AA,TP,1.8X3.2MM  | ...4     | R855         | 2001-000066                             | R-CARBON(S);10KOHM,5%,1/2W,AA,TP,2.4X6.4    |
| ...4     | R421     | 2003-002159                 | R-METAL OXIDE;1500HM,5%,1W,AG,TP,4.3X12M | ...4     | R856         | 2004-004366                             | R-METAL(S);1.3Kohm,1%,1/2W,AA,TP,2.5x6.5    |
| ...4     | R422     | 2001-000028                 | R-CARBON(S);100OHM,5%,1/2W,AA,TP,2.4X6.4 | ...4     | R857         | 2001-000734                             | R-CARBON;4.7KOHM,5%,1/8W,AA,TP,1.8X3.2MM    |
| ...4     | R423     | 2001-000613                 | R-CARBON;3.9KOHM,5%,1/8W,AA,TP,1.8X3.2MM | △        | RP801S       | 2002-001010                             | R-COMPOSITION;1.8Mohm,5%,1/2W,AA,TP,3.7x    |
| ...4     | R426     | 2003-002153                 | R-METAL OXIDE;4.7OHM,5%,2W,AG,TP,6X16MM  | △        | RR401S       | 2001-001088                             | R-CARBON(S);1KOHM,5%,1/2W,AA,TP,2.4X6.4M    |
| ...4     | R427     | 2003-002152                 | R-METAL OXIDE;10HM,5%,2W,AG,TP,6X16MM    | △        | RR402S       | 2103-001086                             | VR-SEMI;100KOHM,25%,0.3W,TOP                |
| ...4     | R427A    | 2003-002152                 | R-METAL OXIDE;10HM,5%,2W,AG,TP,6X16MM    | △        | RR403S       | 2004-004001                             | R-METAL(S);180Kohm,1%,1/2W,AA,TP,2.5x6.5    |
| ...4     | R428     | 2002-001017                 | R-COMPOSITION;1Kohm,10%,1/2W,AA,TP,3.7x9 | △        | RR404S       | 2004-004046                             | R-METAL(S);430Kohm,1%,1/2W,AA,TP,2.5x6.5    |
| ...4     | R428A    | 2002-001017                 | R-COMPOSITION;1Kohm,10%,1/2W,AA,TP,3.7x9 | △        | RR405S       | 2004-004046                             | R-METAL(S);430Kohm,1%,1/2W,AA,TP,2.5x6.5    |
| ...4     | R429     | 2003-000586                 | R-METAL OXIDE(S);22Kohm,5%,2W,AF,TP,4x12 | △        | RR406S       | 2004-001892                             | R-METAL(S);162Kohm,1%,1/2W,AA,TP,2.5x6.5    |
| ...4     | R430     | 2003-000586                 | R-METAL OXIDE(S);22Kohm,5%,2W,AF,TP,4x12 | △        | RR407S       | 2001-000429                             | R-CARBON;1KOHM,5%,1/8W,AA,TP,1.8X3.2MM      |
| ...4     | R431     | 2001-001153                 | R-CARBON(S);470HM,5%,1/2W,AA,TP,2.4X6.4M | △        | RR408S       | 2001-000449                             | R-CARBON;2.2KOHM,5%,1/8W,AA,TP,1.8X3.2MM    |
| ...4     | R433     | 2001-001155                 | R-CARBON(S);5.6KOHM,5%,1/2W,AA,TP,2.4X6  | △        | RR409S       | 2001-000005                             | R-CARBON;390ohm,5%,1/8W,AA,TP,1.8x3.2mm     |
| ...4     | R434     | 2001-001093                 | R-CARBON(S);2.2KOHM,5%,1/2W,AA,TP,2.4X6  | △        | RR410S       | 2001-000290                             | R-CARBON;10KOHM,5%,1/8W,AA,TP,1.8X3.2MM     |
| ...4     | R437     | 2008-001087                 | R-FUSIBLE(S);1.8ohm,5%,2W,AG,TP,3.9x12mm | △        | RR411S       | 2004-001892                             | R-METAL(S);162Kohm,1%,1/2W,AA,TP,2.5x6.5    |
| ...4     | R438     | 2001-000085                 | R-CARBON(S);100KOHM,5%,1/2W,AA,TP,2.4X6  | △        | RR471S       | 2103-001024                             | VR-SEMI;50Kohm,25%,0.3W,TOP                 |
| ...4     | R439     | 2001-000085                 | R-CARBON(S);100KOHM,5%,1/2W,AA,TP,2.4X6  | △        | RS801S       | 2008-000205                             | R-FUSIBLE(S);10ohm,5%,1/2W,AF,TP,2.5x6.5    |
| ...4     | R441     | 2008-000253                 | R-FUSIBLE(S);0.47ohm,5%,1W,AF,TP,3.9x10m | ...4     | RS802        | 2001-001124                             | R-CARBON(S);3.9OHM,5%,1/2W,AA,TP,2.4X6.4    |
| ...4     | R442     | 2008-000253                 | R-FUSIBLE(S);0.47ohm,5%,1W,AF,TP,3.9x10m | ...4     | RS803        | 2001-000085                             | R-CARBON(S);100KOHM,5%,1/2W,AA,TP,2.4X6     |
| ...4     | R442A    | 2008-000253                 | R-FUSIBLE(S);0.47ohm,5%,1W,AF,TP,3.9x10m | ...4     | RS804        | 2001-000066                             | R-CARBON(S);10KOHM,5%,1/2W,AA,TP,2.4X6.4    |
| ...4     | R443     | 2003-002156                 | R-METAL OXIDE;560OHM,5%,2W,AG,TP,6X16MM  | ...4     | RS806        | 2001-001168                             | R-CARBON(S);6.8KOHM,5%,1/2W,AA,TP,2.4X6     |
| ...4     | R443A    | 2003-002156                 | R-METAL OXIDE;560OHM,5%,2W,AG,TP,6X16MM  | ...4     | RS807        | 2001-001088                             | R-CARBON(S);1KOHM,5%,1/2W,AA,TP,2.4X6.4M    |
| ...4     | R445     | 2008-000253                 | R-FUSIBLE(S);0.47ohm,5%,1W,AF,TP,3.9x10m | ...4     | RS808        | 2001-000066                             | R-CARBON(S);10KOHM,5%,1/2W,AA,TP,2.4X6.4    |
| ...4     | R446     | 2001-000734                 | R-CARBON;4.7KOHM,5%,1/8W,AA,TP,1.8X3.2MM | △        | RY801S       | 2002-001013                             | R-COMPOSITION;4.7Mohm,5%,1/2W,AA,TP,3.7x    |
| ...4     | R447     | 2008-000253                 | R-FUSIBLE(S);0.47ohm,5%,1W,AF,TP,3.9x10m | △        | VP801S       | 1405-000152                             | VARISTOR;560V,2500A,14x8.5mm,TP             |
| ...4     | R448     | 2001-000258                 | R-CARBON;1.8KOHM,5%,1/8W,AA,TP,1.8X3.2MM | ...4     | AA41-00598A  | PCB-SUB;CEM-1,1L,A,1.6T,330X245,COMMAND | S.N.A                                       |
| ...4     | R449     | 2008-000253                 | R-FUSIBLE(S);0.47ohm,5%,1W,AF,TP,3.9x10m | ...2     | AA61-011274A | HOLDER-CHASSIS;COMMAND,HIPO V0,64309    | S.N.A                                       |
| ...4     | R454     | 2001-000761                 | R-CARBON;4300HM,5%,1/8W,AA,TP,1.8X3.2MM  | ...2     | AA94-08264A  | ASSY PCB MAIN;MAIN-C2,COMMAND           |   |
| ...4     | R455     | 2001-000761                 | R-CARBON;4300HM,5%,1/8W,AA,TP,1.8X3.2MM  | ...3     | C681         | 2401-000737                             | C-AL;2200uf,20%,50V,GP,TP,18x35.5.7         |
| ...4     | R456     | 2001-000761                 | R-CARBON;4300HM,5%,1/8W,AA,TP,1.8X3.2MM  | ...3     | C801         | 2401-001068                             | C-AL;3300uf,20%,50V,GP,BK,22x40,10          |
| ...4     | R458     | 2001-000577                 | R-CARBON;2KOHM,5%,1/8W,AA,TP,1.8X3.2MM   | ...3     | CN901        | 3703-001187                             | CONNECTOR-DIN;64P,2R,FEMALE,STRAIGHT,AU     |
| ...4     | R459     | 2001-001192                 | R-CARBON(S);820OHM,5%,1/2W,AA,TP,2.4X6.4 | ...3     | CNW01        | 3703-001150                             | CONNECTOR-DIN;32P,2R,FEMALE,STRAIGHT,AUF    |

Electrical Parts List

| Loc. No. | Code No. | Description ; Specification                           | Remark | Loc. No. | Code No. | Description ; Specification                          | Remark |
|----------|----------|---|--------|----------|----------|--|--------|
| ...      | CN201    | 3703-001150 CONNECTOR-DIN;32P,2R,FEMALE,STRAIGHT,AUF  |        | ...      | C937     | 2203-000236 C-CERAMIC,CHIP;0.1nF,5%,50V,NP0,TP,1608  |        |
| ...      | IC601    | AA96-00623E ASSY H/S;SCREW,MAIN,AA62-00056A,TDA7265,  | S.N.A  | ...      | C938     | 2402-001042 C-AL,SMD;100uF,20%,16V,GP,TP,6.6x6.6x5.4 |        |
| ...      | ...      | 0205-000129 GREASE-SILICON;SC102,JAPAN                | S.N.A  | ...      | C950     | 2402-000179 C-AL,SMD;47uF,20%,16V,GP,TP,6.6x6.6x5.4  |        |
| ...      | ...      | 1201-001026 IC-POWER AMP;7265,ZIP,11P,19.6MIL,DUAL,1  |        | ...      | C951     | 2203-000221 C-CERAMIC,CHIP;100nF,20%,50V,Y5V,TP,3216 |        |
| ...      | ...      | 6003-000334 SCREW-TAPTITE,RH,+,2S,M3,L6,ZPC(YEL),SWR  | S.N.A  | ...      | D602     | 0401-000133 DIODE-SWITCHING;RLS4148,100V,200MA,SOD-8 |        |
| ...      | ...      | AA62-00066B HEAT SINK-PS;-;T1.0,-;41*35*70,DZ,-;      | S.N.A  | ...      | D901     | 0401-000133 DIODE-SWITCHING;RLS4148,100V,200MA,SOD-8 |        |
| △        | IC801    | AA96-00475C ASSY H/S;SILICON-OIL,KA278R09,KA7808,AA6  | S.N.A  | ...      | D902     | 0401-000133 DIODE-SWITCHING;RLS4148,100V,200MA,SOD-8 |        |
| ...      | ...      | 1203-001978 IC-VOLTAGE REGULATOR;KA278RA05,TO-220F,4  |        | ...      | D905     | 0401-000133 DIODE-SWITCHING;RLS4148,100V,200MA,SOD-8 |        |
| ...      | ...      | AA62-00066B HEAT SINK;D2,D3,AL,T1.0,89,70,-;AA62-00   | S.N.A  | ...      | D906     | 0401-000133 DIODE-SWITCHING;RLS4148,100V,200MA,SOD-8 |        |
| ...      | ...      | 6003-000334 SCREW-TAPTITE,RH,+,2S,M3,L6,ZPC(YEL),SWR  | S.N.A  | ...      | D920     | 0401-000133 DIODE-SWITCHING;RLS4148,100V,200MA,SOD-8 |        |
| ...      | ...      | 1203-002003 IC-VOLTAGE REGULATOR;278R09,TO-220,4P,-;  |        | ...      | D923     | 0401-000133 DIODE-SWITCHING;RLS4148,100V,200MA,SOD-8 |        |
| ...      | ...      | 1203-000293 IC-POS.FIXED REG.;7808,TO-220,3P,-;PLAS   |        | ...      | DZ904    | 0403-001375 DIODE-ZENER;RLZ3.6B,3.6-3.845V,500mW,LL- |        |
| ...      | ...      | 0205-000129 GREASE-SILICON;SC102,JAPAN                | S.N.A  | ...      | DZ905    | 0403-001375 DIODE-ZENER;RLZ3.6B,3.6-3.845V,500mW,LL- |        |
| △        | IC802    | 1203-000119 IC-NEGA.FIXED REG.;7905,TO-220,3P,-;PLAS  |        | ...      | DZ906    | 0403-001375 DIODE-ZENER;RLZ3.6B,3.6-3.845V,500mW,LL- |        |
| △        | IC808    | BP96-00020G ASSY HEAT SINK P;AA62-00045B,TAPTITE,SI-  | S.N.A  | ...      | DZ907    | 0403-001375 DIODE-ZENER;RLZ3.6B,3.6-3.845V,500mW,LL- |        |
| ...      | CIS      | 0205-000129 GREASE-SILICON;SC102,JAPAN                | S.N.A  | ...      | DZ918    | 0403-001375 DIODE-ZENER;RLZ3.6B,3.6-3.845V,500mW,LL- |        |
| ...      | CIS      | 6003-000334 SCREW-TAPTITE,RH,+,2S,M3,L6,ZPC(YEL),SWR  | S.N.A  | ...      | DZ919    | 0403-001375 DIODE-ZENER;RLZ3.6B,3.6-3.845V,500mW,LL- |        |
| ...      | CIS      | AA62-00045B HEAT SINK;COMMANDO,AL1050,T1.0,H45.0      | S.N.A  | ...      | DZ920    | 0403-001375 DIODE-ZENER;RLZ3.6B,3.6-3.845V,500mW,LL- |        |
| ...      | CIS      | 1203-000203 IC-POS.I.ADJUST REG.;3050,TO-220,5P,-;PLA |        | ...      | IC901    | 1204-001912 IC-DECODER;SDA5550M,P-MQFP,100P,-;PLASTI |        |
| ...      | JA701    | 3722-001426 JACK-PIN;9P;3.4mm,NI,BLK,-                |        | ...      | IC902    | 1103-000180 IC-EEPROM;24C16,2Kx8Bit,SOP,8P,150MIL,10 |        |
| ...      | JA702    | 3722-001871 JACK-PIN;5P(9P);8.3MM,NI,GRN/BLU/RED/WHT  |        | ...      | IC903    | 1203-002302 IC-POS.FIXED REG.;78RM33D,D-PAK,3P,-;PL  |        |
| ...      | JA703    | 3722-001163 JACK-VHS;4P;12mm,AU,BLK,N                 |        | ...      | L901     | 3301-001324 CORE-FERRITE BEAD;AB,150HM,2X1.25X0.9MM, |        |
| ...      | JA704    | 3722-001870 JACK-PIN;5P(10P);8.3MM,NI,GRN/BLU/RED/WH  |        | ...      | L902     | 3301-001324 CORE-FERRITE BEAD;AB,150HM,2X1.25X0.9MM, |        |
| ...      | L801     | AA29-00004A FILTER-LINE NOISE;-;20UH,3A,AC80-260V,TQ  |        | ...      | L903     | 3301-001324 CORE-FERRITE BEAD;AB,150HM,2X1.25X0.9MM, |        |
| ...      | L802     | AA27-10001C COIL-CHOKE;-;100uH,K,-;5.0A,ST,700UH-KIR  |        | ...      | L904     | 3301-001324 CORE-FERRITE BEAD;AB,150HM,2X1.25X0.9MM, |        |
| ...      | TU01     | AA59-00164A MODULE-REF,SPLITTER;-;UMX-NT-005,-;2IN/30 |        | ...      | L905     | 2703-001245 INDUCTOR-SMD;8.2uH,10%,2X1.25X1.25mm     |        |
| ...      | ...      | 0202-000187 SOLDER-WIRE FLUX;-;RS60S,D1.2,63Sn/37Pb   | S.N.A  | ...      | L907     | 3301-001324 CORE-FERRITE BEAD;AB,150HM,2X1.25X0.9MM, |        |
| ...      | ...      | 0202-001167 SOLDER-CREAM;RX3603-2330HO,S45A,PASTE,SN  | S.N.A  | ...      | L920     | 3301-001324 CORE-FERRITE BEAD;AB,150HM,2X1.25X0.9MM, |        |
| ...      | ...      | AA65-30018A CLAMP-WIRE;DONG-A,NYLON-66,-;-;DACL-60    | S.N.A  | ...      | PCB      | AA41-00599A PCB-MICOM;FR-4,2LA,1.6T,180X245,COMMAN   | S.N.A  |
| ...      | ...      | AA65-30104C CLAMP-WIRE;ALL MODEL,NYLON 66,V2,-;NTR,W  | S.N.A  | ...      | Q902     | 0501-000344 TR-SMALL SIGNAL;KSC1623-G,NPN,200mW,SOT- |        |
| ...      | ...      | BP39-00018A LEAD CONNECTOR;P55A/HCM4215W,UJL2547#26,U |        | ...      | Q908     | 0501-000344 TR-SMALL SIGNAL;KSC1623-G,NPN,200mW,SOT- |        |
| ...      | ...      | AA95-02001K ASSY SUB-PCB MICOM;-;C2                   |        | ...      | Q910     | 0501-000344 TR-SMALL SIGNAL;KSC1623-G,NPN,200mW,SOT- |        |
| ...      | CN901    | 3703-001175 CONNECTOR-DIN;64P,2R,MALE,ANGLE,AU        |        | ...      | Q913     | 0501-000344 TR-SMALL SIGNAL;KSC1623-G,NPN,200mW,SOT- |        |
| ...      | D907     | 0402-000274 DIODE-RECTIFIER;UF4004,400V,1A,DO-41,TP   |        | ...      | Q914     | 0501-000344 TR-SMALL SIGNAL;KSC1623-G,NPN,200mW,SOT- |        |
| ...      | IC904    | 1203-001943 IC-VOL. DETECTOR;7025,TO-92,3P,-;PLASTIC  |        | ...      | Q915     | 0501-000344 TR-SMALL SIGNAL;KSC1623-G,NPN,200mW,SOT- |        |
| ...      | IC905    | 1102-001130 IC-EPROM;M27W201-80F6,256KX8BIT,DIP,32P,  |        | ...      | Q916     | 0501-000344 TR-SMALL SIGNAL;KSC1623-G,NPN,200mW,SOT- |        |
| ...      | Q901     | 0505-000109 FET-SILICON;2N7000,N,60V,200mA,5ohm,400m  |        | ...      | Q917     | 0501-000344 TR-SMALL SIGNAL;KSC1623-G,NPN,200mW,SOT- |        |
| ...      | Q903     | 0505-000109 FET-SILICON;2N7000,N,60V,200mA,5ohm,400m  |        | ...      | Q920     | 0501-000344 TR-SMALL SIGNAL;KSC1623-G,NPN,200mW,SOT- |        |
| ...      | X901     | 2801-004071 CRYSTAL-UNIT;6MHZ,30PPM,28-AAAM,20PF,400H |        | ...      | R901     | 2007-000077 R-CHIP;470ohm,5%,1/16W,DA,TP,1608        |        |
| ...      | ...      | 0202-001167 SOLDER-CREAM;RX3603-2330HO,S45A,PASTE,SN  | S.N.A  | ...      | R903     | 2007-000084 R-CHIP;4.7Kohm,5%,1/16W,DA,TP,1608       |        |
| ...      | ...      | 0202-000187 SOLDER-WIRE FLUX;-;RS60S,D1.2,63Sn/37Pb   | S.N.A  | ...      | R904     | 2007-000084 R-CHIP;4.7Kohm,5%,1/16W,DA,TP,1608       |        |
| ...      | ...      | AA97-07275A ASSY SMD,1, . . . .                       | S.N.A  | ...      | R905     | 2007-000078 R-CHIP;1Kohm,5%,1/16W,DA,TP,1608         |        |
| ...      | C901     | 2203-000748 C-CERAMIC,CHIP;0.03nF,5%,50V,NP0,TP,2012  |        | ...      | R906     | 2007-000084 R-CHIP;4.7Kohm,5%,1/16W,DA,TP,1608       |        |
| ...      | C902     | 2203-000440 C-CERAMIC,CHIP;1nF,10%,50V,X7R,TP,1608,-  |        | ...      | R907     | 2007-000074 R-CHIP;100ohm,5%,1/16W,DA,TP,1608        |        |
| ...      | C903     | 2203-000357 C-CERAMIC,CHIP;0.15nF,5%,50V,NP0,TP,1608  |        | ...      | R908     | 2007-000084 R-CHIP;4.7Kohm,5%,1/16W,DA,TP,1608       |        |
| ...      | C904     | 2203-000440 C-CERAMIC,CHIP;1nF,10%,50V,X7R,TP,1608,-  |        | ...      | R909     | 2007-000074 R-CHIP;100ohm,5%,1/16W,DA,TP,1608        |        |
| ...      | C905     | 2203-000444 C-CERAMIC,CHIP;1nF,10%,50V,X7R,TP,2012,-  |        | ...      | R911     | 2007-000076 R-CHIP;330ohm,5%,1/16W,DA,TP,1608        |        |
| ...      | C906     | 2203-000440 C-CERAMIC,CHIP;1nF,10%,50V,X7R,TP,1608,-  |        | ...      | R912     | 2007-000081 R-CHIP;2.7Kohm,5%,1/16W,DA,TP,1608       |        |
| ...      | C907     | 2203-000181 C-CERAMIC,CHIP;100nF,+80-20%,25V,Y5V,TP,  |        | ...      | R913     | 2007-000081 R-CHIP;2.7Kohm,5%,1/16W,DA,TP,1608       |        |
| ...      | C908     | 2203-001048 C-CERAMIC,CHIP;0.56nF,10%,50V,NP0,TP,201  |        | ...      | R914     | 2007-000123 R-CHIP;1.5Kohm,5%,1/16W,DA,TP,1608       |        |
| ...      | C909     | 2203-000260 C-CERAMIC,CHIP;10nF,10%,50V,X7R,TP,2012   |        | ...      | R915     | 2007-000081 R-CHIP;2.7Kohm,5%,1/16W,DA,TP,1608       |        |
| ...      | C910     | 2203-000748 C-CERAMIC,CHIP;0.03nF,5%,50V,NP0,TP,2012  |        | ...      | R916     | 2007-000074 R-CHIP;100ohm,5%,1/16W,DA,TP,1608        |        |
| ...      | C911     | 2402-001049 C-AL,CHIP;10uF,20%,16V,GP,TP,3.3x3.3x5.4  |        | ...      | R917     | 2007-000074 R-CHIP;100ohm,5%,1/16W,DA,TP,1608        |        |
| ...      | C912     | 2402-001049 C-AL,CHIP;10uF,20%,16V,GP,TP,3.3x3.3x5.4  |        | ...      | R918     | 2007-000074 R-CHIP;100ohm,5%,1/16W,DA,TP,1608        |        |
| ...      | C913     | 2402-001042 C-AL,SMD;100uF,20%,16V,GP,TP,6.6x6.6x5.4  |        | ...      | R921     | 2007-000078 R-CHIP;1Kohm,5%,1/16W,DA,TP,1608         |        |
| ...      | C914     | 2203-000181 C-CERAMIC,CHIP;100nF,+80-20%,25V,Y5V,TP,  |        | ...      | R922     | 2007-000074 R-CHIP;100ohm,5%,1/16W,DA,TP,1608        |        |
| ...      | C915     | 2402-001042 C-AL,SMD;100uF,20%,16V,GP,TP,6.6x6.6x5.4  |        | ...      | R923     | 2007-000074 R-CHIP;100ohm,5%,1/16W,DA,TP,1608        |        |
| ...      | C916     | 2203-000181 C-CERAMIC,CHIP;100nF,+80-20%,25V,Y5V,TP,  |        | ...      | R924     | 2007-000078 R-CHIP;1Kohm,5%,1/16W,DA,TP,1608         |        |
| ...      | C917     | 2402-001049 C-AL,CHIP;10uF,20%,16V,GP,TP,3.3x3.3x5.4  |        | ...      | R925     | 2007-000078 R-CHIP;1Kohm,5%,1/16W,DA,TP,1608         |        |
| ...      | C918     | 2402-001042 C-AL,SMD;100uF,20%,16V,GP,TP,6.6x6.6x5.4  |        | ...      | R926     | 2007-000097 R-CHIP;47Kohm,5%,1/16W,DA,TP,1608        |        |
| ...      | C919     | 2203-000181 C-CERAMIC,CHIP;100nF,+80-20%,25V,Y5V,TP,  |        | ...      | R927     | 2007-000084 R-CHIP;4.7Kohm,5%,1/16W,DA,TP,1608       |        |
| ...      | C920     | 2203-000181 C-CERAMIC,CHIP;100nF,+80-20%,25V,Y5V,TP,  |        | ...      | R928     | 2007-000084 R-CHIP;4.7Kohm,5%,1/16W,DA,TP,1608       |        |
| ...      | C921     | 2402-001042 C-AL,SMD;100uF,20%,16V,GP,TP,6.6x6.6x5.4  |        | ...      | R930     | 2007-000078 R-CHIP;1Kohm,5%,1/16W,DA,TP,1608         |        |
| ...      | C922     | 2203-000580 C-CERAMIC,CHIP;1000nF,10%,16V,X7R,TP,201  |        | ...      | R933     | 2007-000078 R-CHIP;1Kohm,5%,1/16W,DA,TP,1608         |        |
| ...      | C924     | 2203-000181 C-CERAMIC,CHIP;100nF,+80-20%,25V,Y5V,TP,  |        | ...      | R934     | 2007-000074 R-CHIP;100ohm,5%,1/16W,DA,TP,1608        |        |
| ...      | C925     | 2203-000181 C-CERAMIC,CHIP;100nF,+80-20%,25V,Y5V,TP,  |        | ...      | R936     | 2007-000078 R-CHIP;1Kohm,5%,1/16W,DA,TP,1608         |        |
| ...      | C926     | 2203-000181 C-CERAMIC,CHIP;100nF,+80-20%,25V,Y5V,TP,  |        | ...      | R939     | 2007-000074 R-CHIP;100ohm,5%,1/16W,DA,TP,1608        |        |
| ...      | C927     | 2203-000181 C-CERAMIC,CHIP;100nF,+80-20%,25V,Y5V,TP,  |        | ...      | R940     | 2007-000074 R-CHIP;100ohm,5%,1/16W,DA,TP,1608        |        |
| ...      | C928     | 2203-000181 C-CERAMIC,CHIP;100nF,+80-20%,25V,Y5V,TP,  |        | ...      | R941     | 2007-000123 R-CHIP;1.5Kohm,5%,1/16W,DA,TP,1608       |        |
| ...      | C929     | 2203-000181 C-CERAMIC,CHIP;100nF,+80-20%,25V,Y5V,TP,  |        | ...      | R942     | 2007-000123 R-CHIP;1.5Kohm,5%,1/16W,DA,TP,1608       |        |
| ...      | C931     | 2203-000181 C-CERAMIC,CHIP;100nF,+80-20%,25V,Y5V,TP,  |        | ...      | R944     | 2007-000090 R-CHIP;10KOHM,5%,1/16W,DA,TP,1608        |        |
| ...      | C932     | 2203-000181 C-CERAMIC,CHIP;100nF,+80-20%,25V,Y5V,TP,  |        | ...      | R945     | 2007-001167 R-CHIP;75ohm,5%,1/16W,DA,TP,1608         |        |
| ...      | C933     | 2203-000236 C-CERAMIC,CHIP;0.1nF,5%,50V,NP0,TP,1608   |        | ...      | R946     | 2007-001167 R-CHIP;75ohm,5%,1/16W,DA,TP,1608         |        |
| ...      | C934     | 2203-000236 C-CERAMIC,CHIP;0.1nF,5%,50V,NP0,TP,1608   |        | ...      | R948     | 2007-001167 R-CHIP;75ohm,5%,1/16W,DA,TP,1608         |        |
| ...      | C935     | 2203-000236 C-CERAMIC,CHIP;0.1nF,5%,50V,NP0,TP,1608   |        | ...      | R949     | 2007-001167 R-CHIP;75ohm,5%,1/16W,DA,TP,1608         |        |
| ...      | C936     | 2402-001042 C-AL,SMD;100uF,20%,16V,GP,TP,6.6x6.6x5.4  |        | ...      | R950     | 2007-001167 R-CHIP;75ohm,5%,1/16W,DA,TP,1608         |        |
| ...      | C936     | 2402-001042 C-AL,SMD;100uF,20%,16V,GP,TP,6.6x6.6x5.4  |        | ...      | R951     | 2007-001167 R-CHIP;75ohm,5%,1/16W,DA,TP,1608         |        |



| Loc. No. | Code No.    | Description ; Specification             | Remark                                   | Loc. No. | Code No. | Description ; Specification | Remark                                    |                                   |
|----------|-------------|---|--|----------|----------|-----------------------------|---|-----------------------------------|
| .....5   | R952        | 2007-000074                             | R-CHIP;100ohm,5%,1/16W,DA,TP,1608        | .....5   | C647     | 2401-001989                 | C-AL;4.7uF,20%,50V,BP,TP,5x11,5           |                                   |
| .....5   | R953        | 2007-000074                             | R-CHIP;100ohm,5%,1/16W,DA,TP,1608        | .....5   | C648     | 2401-001989                 | C-AL;4.7uF,20%,50V,BP,TP,5x11,5           |                                   |
| .....5   | R954        | 2007-000084                             | R-CHIP;4.7Kohm,5%,1/16W,DA,TP,1608       | .....5   | C649     | 2401-001989                 | C-AL;4.7uF,20%,50V,BP,TP,5x11,5           |                                   |
| .....5   | R955        | 2007-000084                             | R-CHIP;4.7Kohm,5%,1/16W,DA,TP,1608       | .....5   | C650     | 2401-001989                 | C-AL;4.7uF,20%,50V,BP,TP,5x11,5           |                                   |
| .....5   | R956        | 2007-000074                             | R-CHIP;100ohm,5%,1/16W,DA,TP,1608        | .....5   | C652     | 2401-000480                 | C-AL;10uF,20%,50V,GP,TP,5x11,5            |                                   |
| .....5   | R957        | 2007-000090                             | R-CHIP;10KOHM,5%,1/16W,DA,TP,1608        | .....5   | C656     | 2401-000480                 | C-AL;10uF,20%,50V,GP,TP,5x11,5            |                                   |
| .....5   | R958        | 2007-000084                             | R-CHIP;4.7Kohm,5%,1/16W,DA,TP,1608       | .....5   | C662     | 2401-002619                 | C-AL;47uF,20%,25V,GP,TP,5x11,5            |                                   |
| .....5   | R959        | 2007-000070                             | R-CHIP;0ohm,5%,1/16W,DA,TP,1608          | .....5   | C664     | 2401-000480                 | C-AL;10uF,20%,50V,GP,TP,5x11,5            |                                   |
| .....5   | R960        | 2007-000070                             | R-CHIP;0ohm,5%,1/16W,DA,TP,1608          | .....5   | C668     | 2401-000480                 | C-AL;10uF,20%,50V,GP,TP,5x11,5            |                                   |
| .....5   | R961        | 2007-000939                             | R-CHIP;47Kohm,1%,1/16W,DA,TP,1608        | .....5   | C669     | 2401-000480                 | C-AL;10uF,20%,50V,GP,TP,5x11,5            |                                   |
| .....5   | R962        | 2007-000583                             | R-CHIP;22Kohm,1%,1/16W,DA,TP,1608        | .....5   | C670     | 2401-000480                 | C-AL;10uF,20%,50V,GP,TP,5x11,5            |                                   |
| .....5   | R963        | 2007-000077                             | R-CHIP;470ohm,5%,1/16W,DA,TP,1608        | .....5   | C674     | 2401-000480                 | C-AL;10uF,20%,50V,GP,TP,5x11,5            |                                   |
| .....5   | R964        | 2007-000070                             | R-CHIP;0ohm,5%,1/16W,DA,TP,1608          | .....5   | C675     | 2401-000480                 | C-AL;10uF,20%,50V,GP,TP,5x11,5            |                                   |
| .....5   | R965        | 2007-000070                             | R-CHIP;0ohm,5%,1/16W,DA,TP,1608          | .....5   | C676     | 2401-000480                 | C-AL;10uF,20%,50V,GP,TP,5x11,5            |                                   |
| .....5   | R966        | 2007-000931                             | R-CHIP;470OHM,5%,1/10W,DA,TP,2012        | .....5   | C679     | 2401-000603                 | C-AL;1uF,20%,50V,GP,TP,5x11,5             |                                   |
| .....5   | R969        | 2007-000074                             | R-CHIP;100ohm,5%,1/16W,DA,TP,1608        | .....5   | C680     | 2401-000603                 | C-AL;1uF,20%,50V,GP,TP,5x11,5             |                                   |
| .....5   | R970        | 2007-000074                             | R-CHIP;100ohm,5%,1/16W,DA,TP,1608        | .....5   | C682     | 2305-000665                 | C-FILM,MPEF;100nF,5%,63V,TP,7.5x4.0x5.0mm |                                   |
| .....5   | R971        | 2007-000084                             | R-CHIP;4.7Kohm,5%,1/16W,DA,TP,1608       | .....5   | C683     | 2401-000962                 | C-AL;22uF,20%,50V,GP,TP,5x11,5            |                                   |
| .....5   | R972        | 2007-000074                             | R-CHIP;100ohm,5%,1/16W,DA,TP,1608        | .....5   | C684     | 2401-000603                 | C-AL;1uF,20%,50V,GP,TP,5x11,5             |                                   |
| .....5   | R974        | 2007-000078                             | R-CHIP;1Kohm,5%,1/16W,DA,TP,1608         | .....5   | C685     | 2401-001192                 | C-AL;33uF,20%,50V,GP,TP,6.3x11,5          |                                   |
| .....5   | R975        | 2007-000121                             | R-CHIP;820ohm,5%,1/16W,DA,TP,1608        | .....5   | C686     | 2401-000192                 | C-AL;1000uF,20%,50V,GP,TP,16x25,7.5       |                                   |
| .....5   | R976        | 2007-000084                             | R-CHIP;4.7Kohm,5%,1/16W,DA,TP,1608       | .....5   | C687     | 2305-000665                 | C-FILM,MPEF;100nF,5%,63V,TP,7.5x4.0x5.0mm |                                   |
| .....5   | R978        | 2007-000084                             | R-CHIP;4.7Kohm,5%,1/16W,DA,TP,1608       | .....5   | C688     | 2401-000192                 | C-AL;1000uF,20%,50V,GP,TP,16x25,7.5       |                                   |
| .....5   | R979        | 2007-000074                             | R-CHIP;100ohm,5%,1/16W,DA,TP,1608        | .....5   | C689     | 2305-000665                 | C-FILM,MPEF;100nF,5%,63V,TP,7.5x4.0x5.0mm |                                   |
| .....5   | R980        | 2007-000084                             | R-CHIP;4.7Kohm,5%,1/16W,DA,TP,1608       | .....5   | C690     | 2401-000027                 | C-AL;4.7uF,20%,50V,GP,TP,5x11,5           |                                   |
| .....5   | R981        | 2007-000070                             | R-CHIP;0ohm,5%,1/16W,DA,TP,1608          | .....5   | C691     | 2401-002300                 | C-AL;47uF,20%,50V,GP,TP,6.3x11,5          |                                   |
| .....5   | R982        | 2007-000084                             | R-CHIP;4.7Kohm,5%,1/16W,DA,TP,1608       | .....5   | C694     | 2301-000192                 | C-FILM,PEF;1nF,5%,50V,TP,5.3x10mm,5mm     |                                   |
| .....5   | R983        | 2007-000084                             | R-CHIP;4.7Kohm,5%,1/16W,DA,TP,1608       | .....5   | C695     | 2301-000192                 | C-FILM,PEF;1nF,5%,50V,TP,5.3x10mm,5mm     |                                   |
| .....5   | R985        | 2007-000084                             | R-CHIP;4.7Kohm,5%,1/16W,DA,TP,1608       | .....5   | C706     | 2401-002619                 | C-AL;47uF,20%,25V,GP,TP,5x11,5            |                                   |
| .....5   | R986        | 2007-000084                             | R-CHIP;4.7Kohm,5%,1/16W,DA,TP,1608       | .....5   | C716     | 2401-001840                 | C-AL;100uF,20%,16V,GP,TP,6.3x11,5         |                                   |
| .....5   | R987        | 2007-000090                             | R-CHIP;10KOHM,5%,1/16W,DA,TP,1608        | .....5   | C720     | 2401-002144                 | C-AL;47uF,20%,16V,GP,TP,5x11,5            |                                   |
| .....5   | R988        | 2007-000290                             | R-CHIP;100OHM,5%,1/10W,DA,TP,2012        | .....5   | C802     | 2401-000471                 | C-AL;10uF,20%,50V,BP,TP,5x11,5mm          |                                   |
| ...3     | AA63-00396B | SHIELD CASE-TOP;PRJT,P54A,SPT,TO.5,-,-, | S.N.A                                    | .....5   | C803     | 2401-001840                 | C-AL;100uF,20%,16V,GP,TP,6.3x11,5         |                                   |
| ...3     | AA63-00397B | SHIELD CASE-BOT;PRJT,P54A,SPT,TO.5,-,-, | S.N.A                                    | .....5   | C806     | 2401-000360                 | C-AL;100uF,20%,50V,GP,TP,8x11.5,5         |                                   |
| ...3     | AA39-20010B | LEAD CONNECTOR-ASSY;1PYFH800-01,S,500,  |  | .....5   | C808     | 2401-002459                 | C-AL;220uF,20%,25V,LZ,TP,10x16,5          |                                   |
| ...3     | AA97-07560J | ASSY ROBOT;                             | S.N.A                                    | .....5   | C809     | 2401-002459                 | C-AL;220uF,20%,25V,LZ,TP,10x16,5          |                                   |
| ...4     | CN801       | 3711-003975                             | CONNECTOR-HEADER;BOX,14P,1R,2.5mm,STRAIG | .....5   | C812     | 2401-002459                 | C-AL;220uF,20%,25V,LZ,TP,10x16,5          |                                   |
| ...4     | CN802       | 3711-004946                             | CONNECTOR-HEADER;BOX,15P,1R,2.5MM,STRAIG | .....5   | C813     | 2401-002459                 | C-AL;220uF,20%,25V,LZ,TP,10x16,5          |                                   |
| ...4     | CN902       | 3711-003971                             | CONNECTOR-HEADER;BOX,11P,1R,2.5mm,STRAIG | .....5   | C816     | 2401-002459                 | C-AL;220uF,20%,25V,LZ,TP,10x16,5          |                                   |
| ...4     | CNY01       | 3711-003641                             | CONNECTOR-HEADER;BOX,12P,1R,2.5mm,STRAIG | .....5   | C817     | 2401-002459                 | C-AL;220uF,20%,25V,LZ,TP,10x16,5          |                                   |
| ...4     | CNZ02       | 3711-003046                             | CONNECTOR-HEADER;BOX,9P,1R,2.5mm,STRAIGH | .....5   | C819     | 2401-001840                 | C-AL;100uF,20%,16V,GP,TP,6.3x11,5         |                                   |
| ...4     | IC807       | 1203-000165                             | IC-POS,ADJUST REG.;78R12,TO-220,4P,-,PL  | .....5   | C822     | 2401-001840                 | C-AL;100uF,20%,16V,GP,TP,6.3x11,5         |                                   |
| ...4     | TU02        | AA40-00041A                             | TUNER-F/S;TCPN3081PC09C(S),NTSC,181CH,45 | .....5   | C823     | 2401-002463                 | C-AL;470uF,20%,16V,GP,TP,8x11,5,5         |                                   |
| ...4     | TU04        | AA40-00041A                             | TUNER-F/S;TCPN3081PC09C(S),NTSC,181CH,45 | .....5   | C826     | 2401-002619                 | C-AL;47uF,20%,25V,GP,TP,5x11,5            |                                   |
| ...4     |             | AA97-07422A                             | ASSY AUTO;0000                           | S.N.A    | .....5   | C827                        | 2401-000832                               | C-AL;220uF,20%,25V,GP,TP,8x11,5,5 |
| .....5   | C102        | 2401-000302                             | C-AL;100uF,20%,25V,GP,TP,6.3x11,5        | .....5   | C830     | 2401-001397                 | C-AL;470uF,20%,25V,GP,TP,10x16,5          |                                   |
| .....5   | C104        | 2401-000039                             | C-AL;1000uF,20%,16V,GP,TP,10x16,5        | .....5   | C831     | 2401-002300                 | C-AL;47uF,20%,50V,GP,TP,6.3x11,5          |                                   |
| .....5   | C106        | 2401-001513                             | C-AL;47uF,20%,16V,WT,TP,5x11,5           | .....5   | C832     | 2401-000039                 | C-AL;1000uF,20%,16V,GP,TP,10x16,5         |                                   |
| .....5   | C108        | 2401-000603                             | C-AL;1uF,20%,50V,GP,TP,5x11,5            | .....5   | C834     | 2401-002594                 | C-AL;220uF,20%,16V,GP,TP,8x11.5,5         |                                   |
| .....5   | C111        | 2401-002463                             | C-AL;470uF,20%,16V,GP,TP,8x11.5,5        | .....5   | C901     | 2401-002619                 | C-AL;47uF,20%,25V,GP,TP,5x11,5            |                                   |
| .....5   | C113        | 2401-000603                             | C-AL;1uF,20%,50V,GP,TP,5x11,5            | .....5   | C903     | 2401-002619                 | C-AL;47uF,20%,25V,GP,TP,5x11,5            |                                   |
| .....5   | C124        | 2401-000962                             | C-AL;22uF,20%,50V,GP,TP,5x11,5           | .....5   | CN101    | 3711-002642                 | CONNECTOR-HEADER;BOX,3P,1R,2.5mm,STRAIGH  |                                   |
| .....5   | C125        | 2401-000962                             | C-AL;22uF,20%,50V,GP,TP,5x11,5           | .....5   | CN201    | 3711-002645                 | CONNECTOR-HEADER;BOX,6P,1R,2.5mm,STRAIGH  |                                   |
| .....5   | C134        | 2401-000962                             | C-AL;22uF,20%,50V,GP,TP,5x11,5           | .....5   | CN601    | 3711-002643                 | CONNECTOR-HEADER;BOX,4P,1R,2.5mm,STRAIGH  |                                   |
| .....5   | C136        | 2401-000962                             | C-AL;22uF,20%,50V,GP,TP,5x11,5           | .....5   | CN903    | 3711-002642                 | CONNECTOR-HEADER;BOX,3P,1R,2.5mm,STRAIGH  |                                   |
| .....5   | C139        | 2401-000962                             | C-AL;22uF,20%,50V,GP,TP,5x11,5           | .....5   | D601     | 0401-000005                 | DIODE-SWITCHING;1N4148,100V,200mA,DO-35,  |                                   |
| .....5   | C147        | 2401-000480                             | C-AL;10uF,20%,50V,GP,TP,5x11,5           | .....5   | D604     | 0401-000005                 | DIODE-SWITCHING;1N4148,100V,200mA,DO-35,  |                                   |
| .....5   | C601        | 2401-000480                             | C-AL;10uF,20%,50V,GP,TP,5x11,5           | .....5   | D605     | 0401-000005                 | DIODE-SWITCHING;1N4148,100V,200mA,DO-35,  |                                   |
| .....5   | C604        | 2401-000480                             | C-AL;10uF,20%,50V,GP,TP,5x11,5           | .....5   | D606     | 0402-000546                 | DIODE-RECTIFIER;TVR10G,400V,1.0A,DO-41,T  |                                   |
| .....5   | C607        | 2401-000962                             | C-AL;22uF,20%,50V,GP,TP,5x11,5           | .....5   | D607     | 0401-000005                 | DIODE-SWITCHING;1N4148,100V,200mA,DO-35,  |                                   |
| .....5   | C609        | 2401-000962                             | C-AL;22uF,20%,50V,GP,TP,5x11,5           | .....5   | D608     | 0401-000005                 | DIODE-SWITCHING;1N4148,100V,200mA,DO-35,  |                                   |
| .....5   | C610        | 2401-000302                             | C-AL;100uF,20%,25V,GP,TP,6.3x11,5        | .....5   | D609     | 0401-000005                 | DIODE-SWITCHING;1N4148,100V,200mA,DO-35,  |                                   |
| .....5   | C612        | 2401-000962                             | C-AL;22uF,20%,50V,GP,TP,5x11,5           | .....5   | DZ605    | 0403-001039                 | DIODE-ZENER;MA2560,56V,52-60V,1W,DO-41,T  |                                   |
| .....5   | C617        | 2401-000962                             | C-AL;22uF,20%,50V,GP,TP,5x11,5           | .....5   | DZ606    | 0403-001325                 | DIODE-ZENER;MTZJ15C,14.35-15.09V,500mW,D  |                                   |
| .....5   | C620        | 2401-000360                             | C-AL;100uF,20%,50V,GP,TP,8x11,5,5        | .....5   | DZ607    | 0403-001319                 | DIODE-ZENER;MTZJ4.7C,4.68-4.93V,500mW,DO  |                                   |
| .....5   | C629        | 2401-000962                             | C-AL;22uF,20%,50V,GP,TP,5x11,5           | .....5   | DZ801    | 0403-000700                 | DIODE-ZENER;TZP33A,33V,31-35V,1W,DO-41,T  |                                   |
| .....5   | C630        | 2401-000962                             | C-AL;22uF,20%,50V,GP,TP,5x11,5           | .....5   | GT01     | AA60-40014A                 | PIN-GT,ASSY;1P,-,-,AUTO                   | S.N.A                             |
| .....5   | C631        | 2401-000480                             | C-AL;10uF,20%,50V,GP,TP,5x11,5           | .....5   | GT02     | AA60-40014A                 | PIN-GT,ASSY;1P,-,-,AUTO                   | S.N.A                             |
| .....5   | C632        | 2401-000480                             | C-AL;10uF,20%,50V,GP,TP,5x11,5           | .....5   | GT03     | AA60-40014A                 | PIN-GT,ASSY;1P,-,-,AUTO                   | S.N.A                             |
| .....5   | C633        | 2401-000480                             | C-AL;10uF,20%,50V,GP,TP,5x11,5           | .....5   | L101     | 2701-000115                 | INDUCTOR-AXIAL;10uH,10%,3x7mm             |                                   |
| .....5   | C639        | 2401-000962                             | C-AL;22uF,20%,50V,GP,TP,5x11,5           | .....5   | L102     | 2701-001040                 | INDUCTOR-AXIAL;10uH,10%,4.5x14mm          |                                   |
| .....5   | C640        | 2401-000962                             | C-AL;22uF,20%,50V,GP,TP,5x11,5           | .....5   | L103     | 2701-000115                 | INDUCTOR-AXIAL;10uH,10%,3x7mm             |                                   |
| .....5   | C642        | 2401-000027                             | C-AL;4.7uF,20%,50V,GP,TP,5x11,5          | .....5   | L104     | 2701-000115                 | INDUCTOR-AXIAL;10uH,10%,3x7mm             |                                   |
| .....5   | C643        | 2401-000027                             | C-AL;4.7uF,20%,50V,GP,TP,5x11,5          | .....5   | L105     | 2701-000106                 | INDUCTOR-AXIAL;1.5uH,10%,3x7mm            |                                   |
| .....5   | C644        | 2401-000027                             | C-AL;4.7uF,20%,50V,GP,TP,5x11,5          | .....5   | L106     | 2701-000115                 | INDUCTOR-AXIAL;10uH,10%,3x7mm             |                                   |
| .....5   | C645        | 2401-001989                             | C-AL;4.7uF,20%,50V,BP,TP,5x11,5          | .....5   | L107     | 2701-000114                 | INDUCTOR-AXIAL;10uH,10%,2.5x3.4mm         |                                   |
| .....5   | C646        | 2401-001989                             | C-AL;4.7uF,20%,50V,BP,TP,5x11,5          | .....5   | L108     | 2701-000114                 | INDUCTOR-AXIAL;10uH,10%,2.5x3.4mm         |                                   |

Electrical Parts List

| Loc. No. | Code No. | Description ; Specification | Remark                                    | Loc. No. | Code No. | Description ; Specification | Remark      |  |
|----------|----------|-----------------------------|---|----------|----------|-----------------------------|-------------|--|
| .....5   | L111     | 2701-000114                 | INDUCTOR-AXIAL;10uH,10%,2.5x3.4mm         |          | .....6   | C141                        | 2203-000236 | C-CERAMIC,CHIP;0.1nF,5%,50V,NPO,TP,1608  |
| .....5   | L112     | 2701-000114                 | INDUCTOR-AXIAL;10uH,10%,2.5x3.4mm         |          | .....6   | C142                        | 2203-000236 | C-CERAMIC,CHIP;0.1nF,5%,50V,NPO,TP,1608  |
| .....5   | L113     | 2701-000114                 | INDUCTOR-AXIAL;10uH,10%,2.5x3.4mm         |          | .....6   | C143                        | 2203-000236 | C-CERAMIC,CHIP;0.1nF,5%,50V,NPO,TP,1608  |
| .....5   | L114     | 2701-000114                 | INDUCTOR-AXIAL;10uH,10%,2.5x3.4mm         |          | .....6   | C145                        | 2203-000236 | C-CERAMIC,CHIP;0.1nF,5%,50V,NPO,TP,1608  |
| .....5   | L119     | 2701-000114                 | INDUCTOR-AXIAL;10uH,10%,2.5x3.4mm         |          | .....6   | C146                        | 2203-000236 | C-CERAMIC,CHIP;0.1nF,5%,50V,NPO,TP,1608  |
| .....5   | L120     | 2701-000114                 | INDUCTOR-AXIAL;10uH,10%,2.5x3.4mm         |          | .....6   | C602                        | 2203-000189 | C-CERAMIC,CHIP;100nF,+80-20%,25V,Y5V,TP, |
| .....5   | L121     | 2701-000114                 | INDUCTOR-AXIAL;10uH,10%,2.5x3.4mm         |          | .....6   | C603                        | 2203-005590 | C-CERAMIC,CHIP;330NF,10%,16V,X7R,TP,2012 |
| .....5   | L122     | 2701-000114                 | INDUCTOR-AXIAL;10uH,10%,2.5x3.4mm         |          | .....6   | C605                        | 2203-000440 | C-CERAMIC,CHIP;1nF,10%,50V,X7R,TP,1608,- |
| .....5   | L123     | 2701-000114                 | INDUCTOR-AXIAL;10uH,10%,2.5x3.4mm         |          | .....6   | C606                        | 2203-000440 | C-CERAMIC,CHIP;1nF,10%,50V,X7R,TP,1608,- |
| .....5   | L124     | 2701-000114                 | INDUCTOR-AXIAL;10uH,10%,2.5x3.4mm         |          | .....6   | C608                        | 2203-000140 | C-CERAMIC,CHIP;1.5nF,10%,50V,X7R,TP,1608 |
| .....5   | L605     | 3301-000287                 | CORE-FERRITE BEAD;AA,3.5x1.0x6.0mm,1500,  |          | .....6   | C611                        | 2203-000440 | C-CERAMIC,CHIP;1nF,10%,50V,X7R,TP,1608,- |
| .....5   | L606     | 3301-000287                 | CORE-FERRITE BEAD;AA,3.5x1.0x6.0mm,1500,  |          | .....6   | C613                        | 2203-000440 | C-CERAMIC,CHIP;1nF,10%,50V,X7R,TP,1608,- |
| .....5   | L703     | 2701-000115                 | INDUCTOR-AXIAL;10uH,10%,3x7mm             |          | .....6   | C614                        | 2203-000140 | C-CERAMIC,CHIP;1.5nF,10%,50V,X7R,TP,1608 |
| .....5   | L705     | 2701-001030                 | INDUCTOR-AXIAL;43uH,10%,5x14mm            |          | .....6   | C619                        | 2203-000189 | C-CERAMIC,CHIP;100nF,+80-20%,25V,Y5V,TP, |
| .....5   | L706     | 2701-001030                 | INDUCTOR-AXIAL;43uH,10%,5x14mm            |          | .....6   | C634                        | 2203-000189 | C-CERAMIC,CHIP;100nF,+80-20%,25V,Y5V,TP, |
| .....5   | Q601     | 0501-000389                 | TR-SMALL SIGNAL;KSC815,NPN,400mW,TO-92,T  |          | .....6   | C635                        | 2203-001211 | C-CERAMIC,CHIP;8.2nF,10%,50V,X7R,TP,1608 |
| .....5   | Q602     | 0501-000389                 | TR-SMALL SIGNAL;KSC815,NPN,400mW,TO-92,T  |          | .....6   | C636                        | 2203-001211 | C-CERAMIC,CHIP;8.2nF,10%,50V,X7R,TP,1608 |
| .....5   | Q603     | 0501-000389                 | TR-SMALL SIGNAL;KSC815,NPN,400mW,TO-92,T  |          | .....6   | C637                        | 2203-001211 | C-CERAMIC,CHIP;8.2nF,10%,50V,X7R,TP,1608 |
| .....5   | R658     | 2001-000812                 | R-CARBON;5.6KOHM,5%,1/8W,AA,TP,1.8X3.2MM  |          | .....6   | C638                        | 2203-001211 | C-CERAMIC,CHIP;8.2nF,10%,50V,X7R,TP,1608 |
| .....5   | R659     | 2001-000734                 | R-CARBON;4.7KOHM,5%,1/8W,AA,TP,1.8X3.2MM  |          | .....6   | C641                        | 2203-000189 | C-CERAMIC,CHIP;100nF,+80-20%,25V,Y5V,TP, |
| .....5   | R660     | 2001-000734                 | R-CARBON;4.7KOHM,5%,1/8W,AA,TP,1.8X3.2MM  |          | .....6   | C651                        | 2203-000189 | C-CERAMIC,CHIP;100nF,+80-20%,25V,Y5V,TP, |
| .....5   | R661     | 2001-000734                 | R-CARBON;4.7KOHM,5%,1/8W,AA,TP,1.8X3.2MM  |          | .....6   | C653                        | 2203-000332 | C-CERAMIC,CHIP;0.012nF,5%,50V,NPO,TP,160 |
| .....5   | R662     | 2001-000660                 | R-CARBON;33KOHM,5%,1/8W,AA,TP,1.8X3.2MM   |          | .....6   | C654                        | 2203-000332 | C-CERAMIC,CHIP;0.012nF,5%,50V,NPO,TP,160 |
| .....5   | R663     | 2001-000007                 | R-CARBON;3KOHM,5%,1/8W,AA,TP,1.8X3.2MM    |          | .....6   | C655                        | 2203-001071 | C-CERAMIC,CHIP;0.056nF,5%,50V,NPO,TP,160 |
| .....5   | R664     | 2001-000780                 | R-CARBON;470OHM,5%,1/8W,AA,TP,1.8X3.2MM   |          | .....6   | C657                        | 2203-000189 | C-CERAMIC,CHIP;100nF,+80-20%,25V,Y5V,TP, |
| .....5   | R665     | 2001-000273                 | R-CARBON;100KOHM,5%,1/8W,AA,TP,1.8X3.2MM  |          | .....6   | C658                        | 2203-001071 | C-CERAMIC,CHIP;0.056nF,5%,50V,NPO,TP,160 |
| .....5   | R666     | 2001-000780                 | R-CARBON;470OHM,5%,1/8W,AA,TP,1.8X3.2MM   |          | .....6   | C659                        | 2203-001071 | C-CERAMIC,CHIP;0.056nF,5%,50V,NPO,TP,160 |
| .....5   | R667     | 2001-000290                 | R-CARBON;10KOHM,5%,1/8W,AA,TP,1.8X3.2MM   |          | .....6   | C660                        | 2203-000236 | C-CERAMIC,CHIP;0.1nF,5%,50V,NPO,TP,1608  |
| .....5   | R668     | 2001-000290                 | R-CARBON;10KOHM,5%,1/8W,AA,TP,1.8X3.2MM   |          | .....6   | C661                        | 2203-000236 | C-CERAMIC,CHIP;0.1nF,5%,50V,NPO,TP,1608  |
| .....5   | R669     | 2001-000290                 | R-CARBON;10KOHM,5%,1/8W,AA,TP,1.8X3.2MM   |          | .....6   | C663                        | 2203-000189 | C-CERAMIC,CHIP;100nF,+80-20%,25V,Y5V,TP, |
| .....5   | R670     | 2001-000411                 | R-CARBON;18KOHM,5%,1/8W,AA,TP,1.8X3.2MM   |          | .....6   | C701                        | 2203-005590 | C-CERAMIC,CHIP;330NF,10%,16V,X7R,TP,2012 |
| .....5   | R671     | 2001-000734                 | R-CARBON;4.7KOHM,5%,1/8W,AA,TP,1.8X3.2MM  |          | .....6   | C702                        | 2203-005590 | C-CERAMIC,CHIP;330NF,10%,16V,X7R,TP,2012 |
| .....5   | R672     | 2001-000812                 | R-CARBON;5.6KOHM,5%,1/8W,AA,TP,1.8X3.2MM  |          | .....6   | C703                        | 2203-005590 | C-CERAMIC,CHIP;330NF,10%,16V,X7R,TP,2012 |
| .....5   | R673     | 2004-001970                 | R-METAL(S);1.8Kohm,1%,1/2W,AA,TP,6.5x2.5  |          | .....6   | C704                        | 2203-005590 | C-CERAMIC,CHIP;330NF,10%,16V,X7R,TP,2012 |
| .....5   | R674     | 2001-001103                 | R-CARBON(S);20KOHM,5%,1/2W,AA,TP,2.4X6.4  |          | .....6   | C705                        | 2203-005005 | C-CERAMIC,CHIP;100nF,10%,16V,X7R,TP,1608 |
| .....5   | R675     | 2004-001390                 | R-METAL(S);1Kohm,2%,1/2W,AA,TP,2.4x6.4mm  |          | .....6   | C707                        | 2203-000189 | C-CERAMIC,CHIP;100nF,+80-20%,25V,Y5V,TP, |
| .....5   | R676     | 2004-001390                 | R-METAL(S);1Kohm,2%,1/2W,AA,TP,2.4x6.4mm  |          | .....6   | C709                        | 2203-000189 | C-CERAMIC,CHIP;100nF,+80-20%,25V,Y5V,TP, |
| .....5   | R677     | 2001-001103                 | R-CARBON(S);20KOHM,5%,1/2W,AA,TP,2.4X6.4  |          | .....6   | C710                        | 2203-001652 | C-CERAMIC,CHIP;470nF,+80-20%,16V,Y5V,TP, |
| .....5   | R678     | 2004-001970                 | R-METAL(S);1.8Kohm,1%,1/2W,AA,TP,6.5x2.5  |          | .....6   | C711                        | 2203-001652 | C-CERAMIC,CHIP;470nF,+80-20%,16V,Y5V,TP, |
| .....5   | R679     | 2004-001970                 | R-METAL(S);1.8Kohm,1%,1/2W,AA,TP,6.5x2.5  |          | .....6   | C712                        | 2203-001652 | C-CERAMIC,CHIP;470nF,+80-20%,16V,Y5V,TP, |
| .....5   | R680     | 2004-001970                 | R-METAL(S);1.8Kohm,1%,1/2W,AA,TP,6.5x2.5  |          | .....6   | C713                        | 2203-001652 | C-CERAMIC,CHIP;470nF,+80-20%,16V,Y5V,TP, |
| .....5   | R681     | 2001-001146                 | R-CARBON(S);4.7OHM,5%,1/2W,AA,TP,2.4X6.4  |          | .....6   | C714                        | 2203-001652 | C-CERAMIC,CHIP;470nF,+80-20%,16V,Y5V,TP, |
| .....5   | R682     | 2001-001146                 | R-CARBON(S);4.7OHM,5%,1/2W,AA,TP,2.4X6.4  |          | .....6   | C715                        | 2203-001652 | C-CERAMIC,CHIP;470nF,+80-20%,16V,Y5V,TP, |
| .....5   | R683     | 2001-000290                 | R-CARBON;10KOHM,5%,1/8W,AA,TP,1.8X3.2MM   |          | .....6   | C717                        | 2203-000260 | C-CERAMIC,CHIP;10nF,10%,50V,X7R,TP,2012  |
| .....5   | R685     | 2001-000100                 | R-CARBON;82KOHM,5%,1/8W,AA,TP,1.8X3.2MM   |          | .....6   | C721                        | 2203-000189 | C-CERAMIC,CHIP;100nF,+80-20%,25V,Y5V,TP, |
| .....5   | R686     | 2001-000331                 | R-CARBON;12KOHM,5%,1/8W,AA,TP,1.8X3.2MM   |          | .....6   | C722                        | 2203-000189 | C-CERAMIC,CHIP;100nF,+80-20%,25V,Y5V,TP, |
| .....5   | R687     | 2001-000812                 | R-CARBON;5.6KOHM,5%,1/8W,AA,TP,1.8X3.2MM  |          | .....6   | C804                        | 2203-000189 | C-CERAMIC,CHIP;100nF,+80-20%,25V,Y5V,TP, |
| .....5   | R801     | 2001-001077                 | R-CARBON(S);150OHM,5%,1/2W,AA,TP,2.4X6.4  |          | .....6   | C805                        | 2203-000189 | C-CERAMIC,CHIP;100nF,+80-20%,25V,Y5V,TP, |
| .....5   | R802     | 2001-000739                 | R-CARBON;4.7MOHM,5%,1/8W,AA,TP,1.8X3.2MM  |          | .....6   | C807                        | 2203-000189 | C-CERAMIC,CHIP;100nF,+80-20%,25V,Y5V,TP, |
| .....5   | R803     | 2001-000739                 | R-CARBON;4.7MOHM,5%,1/8W,AA,TP,1.8X3.2MM  |          | .....6   | C810                        | 2203-000189 | C-CERAMIC,CHIP;100nF,+80-20%,25V,Y5V,TP, |
| .....5   | R804     | 2001-000739                 | R-CARBON;4.7MOHM,5%,1/8W,AA,TP,1.8X3.2MM  |          | .....6   | C811                        | 2203-000189 | C-CERAMIC,CHIP;100nF,+80-20%,25V,Y5V,TP, |
| .....5   | R805     | 2001-000037                 | R-CARBON(S);330OHM,5%,1/2W,AA,TP,2.4X6.4  |          | .....6   | C814                        | 2203-000189 | C-CERAMIC,CHIP;100nF,+80-20%,25V,Y5V,TP, |
| .....5   | R806     | 2001-000739                 | R-CARBON;4.7MOHM,5%,1/8W,AA,TP,1.8X3.2MM  |          | .....6   | C815                        | 2203-000189 | C-CERAMIC,CHIP;100nF,+80-20%,25V,Y5V,TP, |
| .....5   | R808     | 2001-000066                 | R-CARBON(S);10KOHM,5%,1/2W,AA,TP,2.4X6.4  |          | .....6   | C818                        | 2203-000189 | C-CERAMIC,CHIP;100nF,+80-20%,25V,Y5V,TP, |
| .....5   | R809     | 2001-000739                 | R-CARBON;4.7MOHM,5%,1/8W,AA,TP,1.8X3.2MM  |          | .....6   | C820                        | 2203-000181 | C-CERAMIC,CHIP;100nF,+80-20%,25V,Y5V,TP, |
| .....5   | R810     | 2001-000066                 | R-CARBON(S);10KOHM,5%,1/2W,AA,TP,2.4X6.4  |          | .....6   | C821                        | 2203-000181 | C-CERAMIC,CHIP;100nF,+80-20%,25V,Y5V,TP, |
| .....5   | R811     | 2001-001182                 | R-CARBON(S);7.5KOHM,5%,1/2W,AA,TP,2.4X6.4 |          | .....6   | C824                        | 2203-000181 | C-CERAMIC,CHIP;100nF,+80-20%,25V,Y5V,TP, |
| .....5   | R812     | 2001-000577                 | R-CARBON;2KOHM,5%,1/8W,AA,TP,1.8X3.2MM    |          | .....6   | C825                        | 2203-000181 | C-CERAMIC,CHIP;100nF,+80-20%,25V,Y5V,TP, |
| .....5   | R813     | 2001-000508                 | R-CARBON;22KOHM,5%,1/8W,AA,TP,1.8X3.2MM   |          | .....6   | C828                        | 2203-000181 | C-CERAMIC,CHIP;100nF,+80-20%,25V,Y5V,TP, |
| .....5   | R814     | 2003-001098                 | R-METAL OXIDE(S);22Kohm,5%,3W,AA,TP,6x16  |          | .....6   | C829                        | 2203-000181 | C-CERAMIC,CHIP;100nF,+80-20%,25V,Y5V,TP, |
| .....5   | X601     | 2801-003903                 | CRYSTAL-UNIT;18.432MHz,25ppm,28-AAM,12pF  |          | .....6   | C833                        | 2203-000189 | C-CERAMIC,CHIP;100nF,+80-20%,25V,Y5V,TP, |
| .....5   |          | AA97-07233J                 | ASSY SMD;..                               | S.N.A    | .....6   | C835                        | 2203-000189 | C-CERAMIC,CHIP;100nF,+80-20%,25V,Y5V,TP, |
| .....6   | C101     | 2203-000260                 | C-CERAMIC,CHIP;10nF,10%,50V,X7R,TP,2012   |          | .....6   | C902                        | 2203-000189 | C-CERAMIC,CHIP;100nF,+80-20%,25V,Y5V,TP, |
| .....6   | C105     | 2203-000260                 | C-CERAMIC,CHIP;10nF,10%,50V,X7R,TP,2012   |          | .....6   | C904                        | 2203-000189 | C-CERAMIC,CHIP;100nF,+80-20%,25V,Y5V,TP, |
| .....6   | C107     | 2203-000260                 | C-CERAMIC,CHIP;10nF,10%,50V,X7R,TP,2012   |          | .....6   | DZ102                       | 0403-000314 | DIODE-ZENER;RLZJ9.1B,9.1V,8.80-9.30V,400 |
| .....6   | C109     | 2203-000260                 | C-CERAMIC,CHIP;10nF,10%,50V,X7R,TP,2012   |          | .....6   | DZ104                       | 0403-000314 | DIODE-ZENER;RLZJ9.1B,9.1V,8.80-9.30V,400 |
| .....6   | C110     | 2203-000260                 | C-CERAMIC,CHIP;10nF,10%,50V,X7R,TP,2012   |          | .....6   | DZ107                       | 0403-000314 | DIODE-ZENER;RLZJ9.1B,9.1V,8.80-9.30V,400 |
| .....6   | C112     | 2203-000260                 | C-CERAMIC,CHIP;10nF,10%,50V,X7R,TP,2012   |          | .....6   | DZ108                       | 0403-000314 | DIODE-ZENER;RLZJ9.1B,9.1V,8.80-9.30V,400 |
| .....6   | C114     | 2203-000236                 | C-CERAMIC,CHIP;0.1nF,5%,50V,NPO,TP,1608   |          | .....6   | DZ109                       | 0403-000314 | DIODE-ZENER;RLZJ9.1B,9.1V,8.80-9.30V,400 |
| .....6   | C115     | 2203-000236                 | C-CERAMIC,CHIP;0.1nF,5%,50V,NPO,TP,1608   |          | .....6   | DZ601                       | 0403-001016 | DIODE-ZENER;RLZ6.2B,6.2V,5.96-6.27V,400m |
| .....6   | C116     | 2203-000236                 | C-CERAMIC,CHIP;0.1nF,5%,50V,NPO,TP,1608   |          | .....6   | DZ602                       | 0403-001117 | DIODE-ZENER;RLZ12B,5.5%,500mW,LL-34,TP   |
| .....6   | C117     | 2203-000236                 | C-CERAMIC,CHIP;0.1nF,5%,50V,NPO,TP,1608   |          | .....6   | DZ603                       | 0403-001016 | DIODE-ZENER;RLZ6.2B,6.2V,5.96-6.27V,400m |
| .....6   | C120     | 2203-000236                 | C-CERAMIC,CHIP;0.1nF,5%,50V,NPO,TP,1608   |          | .....6   | DZ604                       | 0403-001117 | DIODE-ZENER;RLZ12B,5.5%,500mW,LL-34,TP   |
| .....6   | C121     | 2203-000236                 | C-CERAMIC,CHIP;0.1nF,5%,50V,NPO,TP,1608   |          | .....6   | DZ701                       | 0403-000314 | DIODE-ZENER;RLZJ9.1B,9.1V,8.80-9.30V,400 |
| .....6   | C126     | 2203-000236                 | C-CERAMIC,CHIP;0.1nF,5%,50V,NPO,TP,1608   |          | .....6   | DZ702                       | 0403-001016 | DIODE-ZENER;RLZ6.2B,6.2V,5.96-6.27V,400m |
| .....6   | C127     | 2203-000236                 | C-CERAMIC,CHIP;0.1nF,5%,50V,NPO,TP,1608   |          | .....6   | DZ703                       | 0403-001016 | DIODE-ZENER;RLZ6.2B,6.2V,5.96-6.27V,400m |
| .....6   | C140     | 2203-000236                 | C-CERAMIC,CHIP;0.1nF,5%,50V,NPO,TP,1608   |          | .....6   | DZ704                       | 0403-000314 | DIODE-ZENER;RLZJ9.1B,9.1V,8.80-9.30V,400 |

| Loc. No.     | Code No.    | Description ; Specification              | Remark | Loc. No.    | Code No.    | Description ; Specification        | Remark |
|--------------|-------------|--|--------|-------------|-------------|------------------------------------|--------|
| .....6 DZ705 | 0403-001117 | DIODE-ZENER;RLZ12B,5%,500mW,LL-34,TP     |        | .....6 R602 | 2007-000074 | R-CHIP;100ohm,5%,1/16W,DA,TP,1608  |        |
| .....6 DZ707 | 0403-001016 | DIODE-ZENER;RLZ6.2B,6.2V,5.96-6.27V,400m |        | .....6 R603 | 2007-000078 | R-CHIP;1Kohm,5%,1/16W,DA,TP,1608   |        |
| .....6 IC602 | 1204-002002 | IC-SOUND PROCESSOR;MSP3420G-B11,POFF,80P |        | .....6 R604 | 2007-000084 | R-CHIP;4.7Kohm,5%,1/16W,DA,TP,1608 |        |
| .....6 IC603 | 1201-000541 | IC-OP AMP;062,SOP,8P;153MIL,DUAL,6V/mV,P |        | .....6 R605 | 2007-001010 | R-CHIP;51Kohm,5%,1/16W,DA,TP,1608  |        |
| .....6 IC605 | 1001-001178 | IC-AUDIO SWITCH;TEA6422D,AUDIO SWITCH ,S |        | .....6 R606 | 2007-001179 | R-CHIP;8.2Kohm,5%,1/16W,DA,TP,1608 |        |
| .....6 IC701 | 1001-001177 | IC-VIDEO SWITCH;TEA6425D,VIDEO SWITCH ,S |        | .....6 R607 | 2007-000134 | R-CHIP;33Kohm,5%,1/16W,DA,TP,1608  |        |
| .....6 IC702 | 1001-001177 | IC-VIDEO SWITCH;TEA6425D,VIDEO SWITCH ,S |        | .....6 R608 | 2007-000329 | R-CHIP;11Kohm,5%,1/16W,DA,TP,1608  |        |
| .....6 IC704 | 1002-001048 | IC-A/D&D/A CONVERTER;PCF8591T,8BIT,SOP,1 |        | .....6 R609 | 2007-000329 | R-CHIP;11Kohm,5%,1/16W,DA,TP,1608  |        |
| .....6 L125  | 2703-000398 | INDUCTOR-SMD;10uH,10%,3.2x2.5x2.2mm      |        | .....6 R610 | 2007-001010 | R-CHIP;51Kohm,5%,1/16W,DA,TP,1608  |        |
| .....6 L126  | 2703-000398 | INDUCTOR-SMD;10uH,10%,3.2x2.5x2.2mm      |        | .....6 R611 | 2007-000084 | R-CHIP;4.7Kohm,5%,1/16W,DA,TP,1608 |        |
| .....6 L601  | 2703-000398 | INDUCTOR-SMD;10uH,10%,3.2x2.5x2.2mm      |        | .....6 R612 | 2007-000134 | R-CHIP;33Kohm,5%,1/16W,DA,TP,1608  |        |
| .....6 L602  | 2703-000398 | INDUCTOR-SMD;10uH,10%,3.2x2.5x2.2mm      |        | .....6 R613 | 2007-001179 | R-CHIP;8.2Kohm,5%,1/16W,DA,TP,1608 |        |
| .....6 L603  | 2703-000398 | INDUCTOR-SMD;10uH,10%,3.2x2.5x2.2mm      |        | .....6 R624 | 2007-000074 | R-CHIP;100ohm,5%,1/16W,DA,TP,1608  |        |
| .....6 L604  | 2703-000398 | INDUCTOR-SMD;10uH,10%,3.2x2.5x2.2mm      |        | .....6 R625 | 2007-000074 | R-CHIP;100ohm,5%,1/16W,DA,TP,1608  |        |
| .....6 L701  | 2703-000398 | INDUCTOR-SMD;10uH,10%,3.2x2.5x2.2mm      |        | .....6 R626 | 2007-000074 | R-CHIP;100ohm,5%,1/16W,DA,TP,1608  |        |
| .....6 L702  | 3301-001324 | CORE-FERRITE BEAD;AB,150HM,2X1.25X0.9MM, |        | .....6 R627 | 2007-000074 | R-CHIP;100ohm,5%,1/16W,DA,TP,1608  |        |
| .....6 L707  | 2703-000398 | INDUCTOR-SMD;10uH,10%,3.2x2.5x2.2mm      |        | .....6 R628 | 2007-000078 | R-CHIP;1Kohm,5%,1/16W,DA,TP,1608   |        |
| .....6 L708  | 2703-000398 | INDUCTOR-SMD;10uH,10%,3.2x2.5x2.2mm      |        | .....6 R629 | 2007-000078 | R-CHIP;1Kohm,5%,1/16W,DA,TP,1608   |        |
| .....6 L901  | 2703-000398 | INDUCTOR-SMD;10uH,10%,3.2x2.5x2.2mm      |        | .....6 R630 | 2007-000078 | R-CHIP;1Kohm,5%,1/16W,DA,TP,1608   |        |
| .....6 L902  | 2703-000398 | INDUCTOR-SMD;10uH,10%,3.2x2.5x2.2mm      |        | .....6 R631 | 2007-000078 | R-CHIP;1Kohm,5%,1/16W,DA,TP,1608   |        |
| .....6 PCB   | AA41-00597A | PCB-MAIN;FR-4,2L,A,1.6T,245X245,COMMAND  | S.N.A  | .....6 R632 | 2007-000078 | R-CHIP;1Kohm,5%,1/16W,DA,TP,1608   |        |
| .....6 Q101  | 0501-000344 | TR-SMALL SIGNAL;KSC1623-G,NPN,200mW,SOT- |        | .....6 R633 | 2007-000078 | R-CHIP;1Kohm,5%,1/16W,DA,TP,1608   |        |
| .....6 Q103  | 0501-000344 | TR-SMALL SIGNAL;KSC1623-G,NPN,200mW,SOT- |        | .....6 R634 | 2007-000078 | R-CHIP;1Kohm,5%,1/16W,DA,TP,1608   |        |
| .....6 Q106  | 0501-000344 | TR-SMALL SIGNAL;KSC1623-G,NPN,200mW,SOT- |        | .....6 R635 | 2007-000078 | R-CHIP;1Kohm,5%,1/16W,DA,TP,1608   |        |
| .....6 Q703  | 0501-000344 | TR-SMALL SIGNAL;KSC1623-G,NPN,200mW,SOT- |        | .....6 R636 | 2007-000078 | R-CHIP;1Kohm,5%,1/16W,DA,TP,1608   |        |
| .....6 Q704  | 0501-000344 | TR-SMALL SIGNAL;KSC1623-G,NPN,200mW,SOT- |        | .....6 R637 | 2007-000078 | R-CHIP;1Kohm,5%,1/16W,DA,TP,1608   |        |
| .....6 Q707  | 0501-000344 | TR-SMALL SIGNAL;KSC1623-G,NPN,200mW,SOT- |        | .....6 R641 | 2007-000078 | R-CHIP;1Kohm,5%,1/16W,DA,TP,1608   |        |
| .....6 Q708  | 0501-000344 | TR-SMALL SIGNAL;KSC1623-G,NPN,200mW,SOT- |        | .....6 R642 | 2007-000078 | R-CHIP;1Kohm,5%,1/16W,DA,TP,1608   |        |
| .....6 Q709  | 0501-000344 | TR-SMALL SIGNAL;KSC1623-G,NPN,200mW,SOT- |        | .....6 R643 | 2007-000078 | R-CHIP;1Kohm,5%,1/16W,DA,TP,1608   |        |
| .....6 Q710  | 0501-000344 | TR-SMALL SIGNAL;KSC1623-G,NPN,200mW,SOT- |        | .....6 R646 | 2007-000074 | R-CHIP;100ohm,5%,1/16W,DA,TP,1608  |        |
| .....6 R101  | 2007-000070 | R-CHIP;0ohm,5%,1/16W,DA,TP,1608          |        | .....6 R647 | 2007-000074 | R-CHIP;100ohm,5%,1/16W,DA,TP,1608  |        |
| .....6 R102  | 2007-000074 | R-CHIP;100ohm,5%,1/16W,DA,TP,1608        |        | .....6 R651 | 2007-000078 | R-CHIP;1Kohm,5%,1/16W,DA,TP,1608   |        |
| .....6 R103  | 2007-000074 | R-CHIP;100ohm,5%,1/16W,DA,TP,1608        |        | .....6 R652 | 2007-000078 | R-CHIP;1Kohm,5%,1/16W,DA,TP,1608   |        |
| .....6 R104  | 2007-000828 | R-CHIP;39Kohm,1%,1/16W,DA,TP,1608        |        | .....6 R653 | 2007-000078 | R-CHIP;1Kohm,5%,1/16W,DA,TP,1608   |        |
| .....6 R105  | 2007-000098 | R-CHIP;56Kohm,5%,1/16W,DA,TP,1608        |        | .....6 R688 | 2007-000084 | R-CHIP;4.7Kohm,5%,1/16W,DA,TP,1608 |        |
| .....6 R106  | 2007-000078 | R-CHIP;1Kohm,5%,1/16W,DA,TP,1608         |        | .....6 R701 | 2007-001167 | R-CHIP;75ohm,5%,1/16W,DA,TP,1608   |        |
| .....6 R107  | 2007-000074 | R-CHIP;100ohm,5%,1/16W,DA,TP,1608        |        | .....6 R702 | 2007-001167 | R-CHIP;75ohm,5%,1/16W,DA,TP,1608   |        |
| .....6 R108  | 2007-000074 | R-CHIP;100ohm,5%,1/16W,DA,TP,1608        |        | .....6 R703 | 2007-000074 | R-CHIP;100ohm,5%,1/16W,DA,TP,1608  |        |
| .....6 R109  | 2007-000828 | R-CHIP;39Kohm,1%,1/16W,DA,TP,1608        |        | .....6 R704 | 2007-000097 | R-CHIP;47Kohm,5%,1/16W,DA,TP,1608  |        |
| .....6 R110  | 2007-000098 | R-CHIP;56Kohm,5%,1/16W,DA,TP,1608        |        | .....6 R706 | 2007-000070 | R-CHIP;0ohm,5%,1/16W,DA,TP,1608    |        |
| .....6 R113  | 2007-000074 | R-CHIP;100ohm,5%,1/16W,DA,TP,1608        |        | .....6 R707 | 2007-000074 | R-CHIP;100ohm,5%,1/16W,DA,TP,1608  |        |
| .....6 R114  | 2007-000074 | R-CHIP;100ohm,5%,1/16W,DA,TP,1608        |        | .....6 R708 | 2007-000070 | R-CHIP;0ohm,5%,1/16W,DA,TP,1608    |        |
| .....6 R115  | 2007-000074 | R-CHIP;100ohm,5%,1/16W,DA,TP,1608        |        | .....6 R709 | 2007-000074 | R-CHIP;100ohm,5%,1/16W,DA,TP,1608  |        |
| .....6 R116  | 2007-000074 | R-CHIP;100ohm,5%,1/16W,DA,TP,1608        |        | .....6 R710 | 2007-001167 | R-CHIP;75ohm,5%,1/16W,DA,TP,1608   |        |
| .....6 R117  | 2007-000070 | R-CHIP;0ohm,5%,1/16W,DA,TP,1608          |        | .....6 R712 | 2007-000070 | R-CHIP;0ohm,5%,1/16W,DA,TP,1608    |        |
| .....6 R118  | 2007-001167 | R-CHIP;75ohm,5%,1/16W,DA,TP,1608         |        | .....6 R713 | 2007-001167 | R-CHIP;75ohm,5%,1/16W,DA,TP,1608   |        |
| .....6 R119  | 2007-001167 | R-CHIP;75ohm,5%,1/16W,DA,TP,1608         |        | .....6 R714 | 2007-001167 | R-CHIP;75ohm,5%,1/16W,DA,TP,1608   |        |
| .....6 R120  | 2007-001167 | R-CHIP;75ohm,5%,1/16W,DA,TP,1608         |        | .....6 R716 | 2007-000097 | R-CHIP;47Kohm,5%,1/16W,DA,TP,1608  |        |
| .....6 R121  | 2007-001167 | R-CHIP;75ohm,5%,1/16W,DA,TP,1608         |        | .....6 R722 | 2007-000074 | R-CHIP;100ohm,5%,1/16W,DA,TP,1608  |        |
| .....6 R125  | 2007-000074 | R-CHIP;100ohm,5%,1/16W,DA,TP,1608        |        | .....6 R724 | 2007-000074 | R-CHIP;100ohm,5%,1/16W,DA,TP,1608  |        |
| .....6 R126  | 2007-000074 | R-CHIP;100ohm,5%,1/16W,DA,TP,1608        |        | .....6 R725 | 2007-001167 | R-CHIP;75ohm,5%,1/16W,DA,TP,1608   |        |
| .....6 R127  | 2007-000074 | R-CHIP;100ohm,5%,1/16W,DA,TP,1608        |        | .....6 R726 | 2007-001167 | R-CHIP;75ohm,5%,1/16W,DA,TP,1608   |        |
| .....6 R132  | 2007-001167 | R-CHIP;75ohm,5%,1/16W,DA,TP,1608         |        | .....6 R727 | 2007-001167 | R-CHIP;75ohm,5%,1/16W,DA,TP,1608   |        |
| .....6 R133  | 2007-001167 | R-CHIP;75ohm,5%,1/16W,DA,TP,1608         |        | .....6 R728 | 2007-000078 | R-CHIP;1Kohm,5%,1/16W,DA,TP,1608   |        |
| .....6 R134  | 2007-001167 | R-CHIP;75ohm,5%,1/16W,DA,TP,1608         |        | .....6 R729 | 2007-000070 | R-CHIP;0ohm,5%,1/16W,DA,TP,1608    |        |
| .....6 R137  | 2007-001167 | R-CHIP;75ohm,5%,1/16W,DA,TP,1608         |        | .....6 R730 | 2007-000076 | R-CHIP;330ohm,5%,1/16W,DA,TP,1608  |        |
| .....6 R138  | 2007-001167 | R-CHIP;75ohm,5%,1/16W,DA,TP,1608         |        | .....6 R731 | 2007-001167 | R-CHIP;75ohm,5%,1/16W,DA,TP,1608   |        |
| .....6 R140  | 2007-001167 | R-CHIP;75ohm,5%,1/16W,DA,TP,1608         |        | .....6 R738 | 2007-000127 | R-CHIP;9.1Kohm,5%,1/16W,DA,TP,1608 |        |
| .....6 R142  | 2007-001167 | R-CHIP;75ohm,5%,1/16W,DA,TP,1608         |        | .....6 R739 | 2007-000093 | R-CHIP;20Kohm,5%,1/16W,DA,TP,1608  |        |
| .....6 R143  | 2007-000070 | R-CHIP;0ohm,5%,1/16W,DA,TP,1608          |        | .....6 R740 | 2007-000127 | R-CHIP;9.1Kohm,5%,1/16W,DA,TP,1608 |        |
| .....6 R145  | 2007-000070 | R-CHIP;0ohm,5%,1/16W,DA,TP,1608          |        | .....6 R741 | 2007-000093 | R-CHIP;20Kohm,5%,1/16W,DA,TP,1608  |        |
| .....6 R148  | 2007-000070 | R-CHIP;0ohm,5%,1/16W,DA,TP,1608          |        | .....6 R742 | 2007-000127 | R-CHIP;9.1Kohm,5%,1/16W,DA,TP,1608 |        |
| .....6 R149  | 2007-000094 | R-CHIP;22Kohm,5%,1/16W,DA,TP,1608        |        | .....6 R743 | 2007-000093 | R-CHIP;20Kohm,5%,1/16W,DA,TP,1608  |        |
| .....6 R150  | 2007-000077 | R-CHIP;470ohm,5%,1/16W,DA,TP,1608        |        | .....6 R744 | 2007-000093 | R-CHIP;20Kohm,5%,1/16W,DA,TP,1608  |        |
| .....6 R151  | 2007-000094 | R-CHIP;22Kohm,5%,1/16W,DA,TP,1608        |        | .....6 R745 | 2007-000127 | R-CHIP;9.1Kohm,5%,1/16W,DA,TP,1608 |        |
| .....6 R155  | 2007-000094 | R-CHIP;22Kohm,5%,1/16W,DA,TP,1608        |        | .....6 R746 | 2007-000090 | R-CHIP;10KOHM,5%,1/16W,DA,TP,1608  |        |
| .....6 R156  | 2007-000094 | R-CHIP;22Kohm,5%,1/16W,DA,TP,1608        |        | .....6 R747 | 2007-000090 | R-CHIP;10KOHM,5%,1/16W,DA,TP,1608  |        |
| .....6 R157  | 2007-000077 | R-CHIP;470ohm,5%,1/16W,DA,TP,1608        |        | .....6 R748 | 2007-000090 | R-CHIP;10KOHM,5%,1/16W,DA,TP,1608  |        |
| .....6 R164  | 2007-000094 | R-CHIP;22Kohm,5%,1/16W,DA,TP,1608        |        | .....6 R749 | 2007-000090 | R-CHIP;10KOHM,5%,1/16W,DA,TP,1608  |        |
| .....6 R165  | 2007-000094 | R-CHIP;22Kohm,5%,1/16W,DA,TP,1608        |        | .....6 R750 | 2007-000084 | R-CHIP;4.7Kohm,5%,1/16W,DA,TP,1608 |        |
| .....6 R166  | 2007-000077 | R-CHIP;470ohm,5%,1/16W,DA,TP,1608        |        | .....6 R751 | 2007-001010 | R-CHIP;51Kohm,5%,1/16W,DA,TP,1608  |        |
| .....6 R170  | 2007-000074 | R-CHIP;100ohm,5%,1/16W,DA,TP,1608        |        | .....6 R752 | 2007-001010 | R-CHIP;51Kohm,5%,1/16W,DA,TP,1608  |        |
| .....6 R171  | 2007-000074 | R-CHIP;100ohm,5%,1/16W,DA,TP,1608        |        | .....6 R753 | 2007-001010 | R-CHIP;51Kohm,5%,1/16W,DA,TP,1608  |        |
| .....6 R172  | 2007-000074 | R-CHIP;100ohm,5%,1/16W,DA,TP,1608        |        | .....6 R754 | 2007-001010 | R-CHIP;51Kohm,5%,1/16W,DA,TP,1608  |        |
| .....6 R173  | 2007-001167 | R-CHIP;75ohm,5%,1/16W,DA,TP,1608         |        | .....6 R755 | 2007-000084 | R-CHIP;4.7Kohm,5%,1/16W,DA,TP,1608 |        |
| .....6 R174  | 2007-001167 | R-CHIP;75ohm,5%,1/16W,DA,TP,1608         |        | .....6 R756 | 2007-000074 | R-CHIP;100ohm,5%,1/16W,DA,TP,1608  |        |
| .....6 R601  | 2007-000074 | R-CHIP;100ohm,5%,1/16W,DA,TP,1608        |        | .....6 R757 | 2007-000074 | R-CHIP;100ohm,5%,1/16W,DA,TP,1608  |        |

| Loc. No. | Code No.    | Description ; Specification       | Remark                                   | Loc. No. | Code No. | Description ; Specification | Remark  |  |
|----------|-------------|-----------------------------------|--|----------|----------|-----------------------------|---|--|
| .....6   | R775        | 2007-000070                       | R-CHIP;0ohm,5%,1/16W,DA,TP,1608          | .....5   | C59      | 2203-000357                 | C-CERAMIC,CHIP;0.15nF,5%,50V,NPO,TP,1608      |  |
| .....6   | R776        | 2007-000070                       | R-CHIP;0ohm,5%,1/16W,DA,TP,1608          | .....5   | C60      | 2203-001071                 | C-CERAMIC,CHIP;0.056nF,5%,50V,NPO,TP,160      |  |
| .....6   | R777        | 2007-000070                       | R-CHIP;0ohm,5%,1/16W,DA,TP,1608          | .....5   | C61      | 2203-000041                 | C-CERAMIC,CHIP;0.01nF,0.25pF,50V,NPO,TP,      |  |
| .....6   | R780        | 2007-000084                       | R-CHIP;4.7Kohm,5%,1/16W,DA,TP,1608       | .....5   | C62      | 2203-000181                 | C-CERAMIC,CHIP;100nF,+80-20%,25V,Y5V,TP,      |  |
| .....6   | R788        | 2007-000070                       | R-CHIP;0ohm,5%,1/16W,DA,TP,1608          | .....5   | C63      | 2203-000357                 | C-CERAMIC,CHIP;0.15nF,5%,50V,NPO,TP,1608      |  |
| .....6   | R789        | 2007-000070                       | R-CHIP;0ohm,5%,1/16W,DA,TP,1608          | .....5   | C64      | 2203-001071                 | C-CERAMIC,CHIP;0.056nF,5%,50V,NPO,TP,160      |  |
| .....6   | R791        | 2007-000070                       | R-CHIP;0ohm,5%,1/16W,DA,TP,1608          | .....5   | C65      | 2203-000041                 | C-CERAMIC,CHIP;0.01nF,0.25pF,50V,NPO,TP,      |  |
| .....6   | R792        | 2007-001167                       | R-CHIP;75ohm,5%,1/16W,DA,TP,1608         | .....5   | C66      | 2203-001083                 | C-CERAMIC,CHIP;0.005nF,0.1pF,50V,NPO,TP,      |  |
| .....6   | R793        | 2007-000078                       | R-CHIP;1Kohm,5%,1/16W,DA,TP,1608         | .....5   | C67      | 2203-001083                 | C-CERAMIC,CHIP;0.005nF,0.1pF,50V,NPO,TP,      |  |
| .....6   | R794        | 2007-000070                       | R-CHIP;0ohm,5%,1/16W,DA,TP,1608          | .....5   | C68      | 2203-001083                 | C-CERAMIC,CHIP;0.005nF,0.1pF,50V,NPO,TP,      |  |
| .....6   | R795        | 2007-000070                       | R-CHIP;0ohm,5%,1/16W,DA,TP,1608          | .....5   | C69      | 2203-001083                 | C-CERAMIC,CHIP;0.005nF,0.1pF,50V,NPO,TP,      |  |
| .....6   | R797        | 2007-000468                       | R-CHIP;1KOHM,5%,1/10W,DA,TP,2012         | .....5   | C70      | 2402-001042                 | C-AL,SMD;100uF,20%,16V,GP,TP,6.6x6.6x5.4      |  |
| .....6   | R798        | 2007-000468                       | R-CHIP;1KOHM,5%,1/10W,DA,TP,2012         | .....5   | C71      | 2203-000181                 | C-CERAMIC,CHIP;100nF,+80-20%,25V,Y5V,TP,      |  |
| .....6   | R799        | 2007-001167                       | R-CHIP;75ohm,5%,1/16W,DA,TP,1608         | .....5   | C72      | 2203-000257                 | C-CERAMIC,CHIP;10nF,10%,50V,X7R,TP,1608       |  |
| .....6   | R79B        | 2007-000070                       | R-CHIP;0ohm,5%,1/16W,DA,TP,1608          | .....5   | C73      | 2203-000975                 | C-CERAMIC,CHIP;47nF,10%,25V,X7R,TP,1608,      |  |
| .....6   | R904        | 2007-000070                       | R-CHIP;0ohm,5%,1/16W,DA,TP,1608          | .....5   | C74      | 2203-000975                 | C-CERAMIC,CHIP;47nF,10%,25V,X7R,TP,1608,      |  |
| .....6   | R97C        | 2007-000070                       | R-CHIP;0ohm,5%,1/16W,DA,TP,1608          | .....5   | C75      | 2203-000257                 | C-CERAMIC,CHIP;10nF,10%,50V,X7R,TP,1608       |  |
| .....3   | AA95-02039A | ASSY SUB-PCB,CONV MDL,COMMANDO, . |  | .....5   | C77      | 2203-000440                 | C-CERAMIC,CHIP;1nF,10%,50V,X7R,TP,1608-       |  |
| .....4   | CN01        | 3703-001124                       | CONNECTOR-DIN;32P,2R,MALE,ANGLE,AUF      | .....5   | C78      | 2203-000181                 | C-CERAMIC,CHIP;100nF,+80-20%,25V,Y5V,TP,      |  |
| .....4   | CN04        | 3711-003601                       | CONNECTOR-HEADER;BOX,12P,1R,2.5mm,ANGLE, | .....5   | C79      | 2203-000181                 | C-CERAMIC,CHIP;100nF,+80-20%,25V,Y5V,TP,      |  |
| .....4   |             | 0202-000187                       | SOLDER-WIRE FLUX;-RS60S,D1.2,63Sn/37Pb   | S.N.A    | .....5   | C80                         | 2402-001049                                   | C-AL,CHIP;10uF,20%,16V,GP,TP,3.3x3.3x5.4 |
| .....4   |             | 0202-001167                       | SOLDER-CREAM;RX3603-2330HO,S45A,PASTE,SN | S.N.A    | .....5   | C81                         | 2203-000041                                   | C-CERAMIC,CHIP;0.01nF,0.25pF,50V,NPO,TP, |
| .....4   |             | AA97-07269A                       | ASSY SMD,1, . . . .                      | S.N.A    | .....5   | C82                         | 2203-001071                                   | C-CERAMIC,CHIP;0.056nF,5%,50V,NPO,TP,160 |
| .....5   | C01         | 2402-001042                       | C-AL,SMD;100uF,20%,16V,GP,TP,6.6x6.6x5.4 | .....5   | C83      | 2203-000181                 | C-CERAMIC,CHIP;100nF,+80-20%,25V,Y5V,TP,      |  |
| .....5   | C02         | 2203-000181                       | C-CERAMIC,CHIP;100nF,+80-20%,25V,Y5V,TP, | .....5   | C84      | 2402-001042                 | C-AL,SMD;100uF,20%,16V,GP,TP,6.6x6.6x5.4      |  |
| .....5   | C03         | 2402-001042                       | C-AL,SMD;100uF,20%,16V,GP,TP,6.6x6.6x5.4 | .....5   | C85      | 2203-000181                 | C-CERAMIC,CHIP;100nF,+80-20%,25V,Y5V,TP,      |  |
| .....5   | C04         | 2203-000181                       | C-CERAMIC,CHIP;100nF,+80-20%,25V,Y5V,TP, | .....5   | C86      | 2203-000181                 | C-CERAMIC,CHIP;100nF,+80-20%,25V,Y5V,TP,      |  |
| .....5   | C05         | 2203-000181                       | C-CERAMIC,CHIP;100nF,+80-20%,25V,Y5V,TP, | .....5   | C87      | 2203-001245                 | C-CERAMIC,CHIP;0.082nF,5%,50V,NPO,TP,201      |  |
| .....5   | C06         | 2402-001042                       | C-AL,SMD;100uF,20%,16V,GP,TP,6.6x6.6x5.4 | .....5   | C88      | 2203-000975                 | C-CERAMIC,CHIP;47nF,10%,25V,X7R,TP,1608,      |  |
| .....5   | C07         | 2203-000181                       | C-CERAMIC,CHIP;100nF,+80-20%,25V,Y5V,TP, | .....5   | C89      | 2203-000257                 | C-CERAMIC,CHIP;10nF,10%,50V,X7R,TP,1608       |  |
| .....5   | C08         | 2203-000181                       | C-CERAMIC,CHIP;100nF,+80-20%,25V,Y5V,TP, | .....5   | C90      | 2203-000575                 | C-CERAMIC,CHIP;220NF,10%,25V,X7R,TP,2012      |  |
| .....5   | C09         | 2203-000181                       | C-CERAMIC,CHIP;100nF,+80-20%,25V,Y5V,TP, | .....5   | C91      | 2203-000575                 | C-CERAMIC,CHIP;220NF,10%,25V,X7R,TP,2012      |  |
| .....5   | C10         | 2203-000181                       | C-CERAMIC,CHIP;100nF,+80-20%,25V,Y5V,TP, | .....5   | D01      | 0401-000160                 | DIODE-SWITCHING;ISS314,30V,100mA,USC,TP       |  |
| .....5   | C11         | 2203-000181                       | C-CERAMIC,CHIP;100nF,+80-20%,25V,Y5V,TP, | .....5   | D02      | 0401-000160                 | DIODE-SWITCHING;ISS314,30V,100mA,USC,TP       |  |
| .....5   | C12         | 2203-000181                       | C-CERAMIC,CHIP;100nF,+80-20%,25V,Y5V,TP, | .....5   | D03      | 0401-000160                 | DIODE-SWITCHING;ISS314,30V,100mA,USC,TP       |  |
| .....5   | C13         | 2203-000181                       | C-CERAMIC,CHIP;100nF,+80-20%,25V,Y5V,TP, | .....5   | D04      | 0401-000160                 | DIODE-SWITCHING;ISS314,30V,100mA,USC,TP       |  |
| .....5   | C14         | 2402-001042                       | C-AL,SMD;100uF,20%,16V,GP,TP,6.6x6.6x5.4 | .....5   | D05      | 0401-000160                 | DIODE-SWITCHING;ISS314,30V,100mA,USC,TP       |  |
| .....5   | C15         | 2203-000181                       | C-CERAMIC,CHIP;100nF,+80-20%,25V,Y5V,TP, | .....5   | D06      | 0401-000160                 | DIODE-SWITCHING;ISS314,30V,100mA,USC,TP       |  |
| .....5   | C20         | 2203-000181                       | C-CERAMIC,CHIP;100nF,+80-20%,25V,Y5V,TP, | .....5   | DZ01     | 0403-001016                 | DIODE-ZENER;RL26.2B,6.2V,5.96-6.27V,400m      |  |
| .....5   | C21         | 2203-000181                       | C-CERAMIC,CHIP;100nF,+80-20%,25V,Y5V,TP, | .....5   | DZ02     | 0403-001016                 | DIODE-ZENER;RL26.2B,6.2V,5.96-6.27V,400m      |  |
| .....5   | C22         | 2203-000181                       | C-CERAMIC,CHIP;100nF,+80-20%,25V,Y5V,TP, | .....5   | DZ03     | 0403-001016                 | DIODE-ZENER;RL26.2B,6.2V,5.96-6.27V,400m      |  |
| .....5   | C23         | 2203-000181                       | C-CERAMIC,CHIP;100nF,+80-20%,25V,Y5V,TP, | .....5   | EF01     | 2901-000229                 | FILTER-EMI SMD;50V,0.3A,-,22000pF,4.5x3.      |  |
| .....5   | C24         | 2203-000181                       | C-CERAMIC,CHIP;100nF,+80-20%,25V,Y5V,TP, | .....5   | EF02     | 2901-000229                 | FILTER-EMI SMD;50V,0.3A,-,22000pF,4.5x3.      |  |
| .....5   | C25         | 2203-000181                       | C-CERAMIC,CHIP;100nF,+80-20%,25V,Y5V,TP, | .....5   | EF03     | 3301-001324                 | CORE-FERRITE BEAD;AB,150HM,2X1.25X0.9MM,      |  |
| .....5   | C26         | 2203-000181                       | C-CERAMIC,CHIP;100nF,+80-20%,25V,Y5V,TP, | .....5   | EF04     | 3301-001324                 | CORE-FERRITE BEAD;AB,150HM,2X1.25X0.9MM,      |  |
| .....5   | C27         | 2203-000181                       | C-CERAMIC,CHIP;100nF,+80-20%,25V,Y5V,TP, | .....5   | EF05     | 2901-000226                 | FILTER-EMI SMD;25V,0.3A,-,100pF,3.2x1.25      |  |
| .....5   | C28         | 2203-000181                       | C-CERAMIC,CHIP;100nF,+80-20%,25V,Y5V,TP, | .....5   | EF06     | 2901-000226                 | FILTER-EMI SMD;25V,0.3A,-,100pF,3.2x1.25      |  |
| .....5   | C29         | 2203-000181                       | C-CERAMIC,CHIP;100nF,+80-20%,25V,Y5V,TP, | .....5   | EF07     | 3301-001324                 | CORE-FERRITE BEAD;AB,150HM,2X1.25X0.9MM,      |  |
| .....5   | C30         | 2203-000181                       | C-CERAMIC,CHIP;100nF,+80-20%,25V,Y5V,TP, | .....5   | EF08     | 3301-001324                 | CORE-FERRITE BEAD;AB,150HM,2X1.25X0.9MM,      |  |
| .....5   | C31         | 2203-000181                       | C-CERAMIC,CHIP;100nF,+80-20%,25V,Y5V,TP, | .....5   | EF09     | 3301-001324                 | CORE-FERRITE BEAD;AB,150HM,2X1.25X0.9MM,      |  |
| .....5   | C32         | 2203-000181                       | C-CERAMIC,CHIP;100nF,+80-20%,25V,Y5V,TP, | .....5   | EF10     | 3301-001324                 | CORE-FERRITE BEAD;AB,150HM,2X1.25X0.9MM,      |  |
| .....5   | C33         | 2203-000181                       | C-CERAMIC,CHIP;100nF,+80-20%,25V,Y5V,TP, | .....5   | IC01     | BP13-00003A                 | IC ASIC;SDC12,128,-0.3 TO +3.8,0 TO 70,Q      |  |
| .....5   | C34         | 2203-000181                       | C-CERAMIC,CHIP;100nF,+80-20%,25V,Y5V,TP, | .....5   | IC02     | 1203-002302                 | IC-POSIFIXED REG.;78RM33D,D-PAK,3P,-PL        |  |
| .....5   | C35         | 2203-000181                       | C-CERAMIC,CHIP;100nF,+80-20%,25V,Y5V,TP, | .....5   | IC03     | 1203-001824                 | IC-VOL. DETECTOR;7042,SOT-89,3P,-PLASTI       |  |
| .....5   | C36         | 2203-000181                       | C-CERAMIC,CHIP;100nF,+80-20%,25V,Y5V,TP, | .....5   | IC04     | 0801-002345                 | IC-CMOS LOGIC;7S04,INVERTER,SOT-353,5P,4      |  |
| .....5   | C37         | 2203-000181                       | C-CERAMIC,CHIP;100nF,+80-20%,25V,Y5V,TP, | .....5   | IC05     | 1103-001195                 | IC-EEPROM;24C64,8Kx8Bit,SOP8P,150MIL,10       |  |
| .....5   | C38         | 2402-001042                       | C-AL,SMD;100uF,20%,16V,GP,TP,6.6x6.6x5.4 | .....5   | IC06     | AA09-00032A                 | IC-MCU;TSC87251G2D-OTP,4.5 TO 5.5V,-,32       |  |
| .....5   | C39         | 2203-000181                       | C-CERAMIC,CHIP;100nF,+80-20%,25V,Y5V,TP, | .....5   | IC07     | 1201-001520                 | IC-VIDEO AMP;EL2250CS,SOIC,8P,150MIL,DUA      |  |
| .....5   | C40         | 2402-001042                       | C-AL,SMD;100uF,20%,16V,GP,TP,6.6x6.6x5.4 | .....5   | IC08     | 1001-000164                 | IC-ANALOG MULTIPLEX;74HC4052,CMOS,SOP,16      |  |
| .....5   | C41         | 2203-000181                       | C-CERAMIC,CHIP;100nF,+80-20%,25V,Y5V,TP, | .....5   | IC09     | 1201-001504                 | IC-OP AMP;072,SOP,8P,150MIL,DUAL,-,PLAST      |  |
| .....5   | C42         | 2203-000357                       | C-CERAMIC,CHIP;0.15nF,5%,50V,NPO,TP,1608 | .....5   | IC10     | 1201-001504                 | IC-OP AMP;072,SOP,8P,150MIL,DUAL,-,PLAST      |  |
| .....5   | C43         | 2203-001071                       | C-CERAMIC,CHIP;0.056nF,5%,50V,NPO,TP,160 | .....5   | IC11     | 1201-001504                 | IC-OP AMP;072,SOP,8P,150MIL,DUAL,-,PLAST      |  |
| .....5   | C44         | 2203-000041                       | C-CERAMIC,CHIP;0.01nF,0.25pF,50V,NPO,TP, | .....5   | IC12     | 1201-001135                 | IC-OP AMP;324,SOP,ST,14P,150MIL,QUAD,100      |  |
| .....5   | C45         | 2203-000181                       | C-CERAMIC,CHIP;100nF,+80-20%,25V,Y5V,TP, | .....5   | IC13     | 1001-001155                 | IC-ANALOG MULTIPLEX;NC7SB3157P6X,CMOS,SC      |  |
| .....5   | C46         | 2203-000357                       | C-CERAMIC,CHIP;0.15nF,5%,50V,NPO,TP,1608 | .....5   | IC14     | 1201-001504                 | IC-OP AMP;072,SOP,8P,150MIL,DUAL,-,PLAST      |  |
| .....5   | C47         | 2203-001071                       | C-CERAMIC,CHIP;0.056nF,5%,50V,NPO,TP,160 | .....5   | IC15     | 0801-002345                 | IC-CMOS LOGIC;7S04,INVERTER,SOT-353,5P,4      |  |
| .....5   | C48         | 2203-000041                       | C-CERAMIC,CHIP;0.01nF,0.25pF,50V,NPO,TP, | .....5   | IC16     | 0801-002345                 | IC-CMOS LOGIC;7S04,INVERTER,SOT-353,5P,4      |  |
| .....5   | C49         | 2203-000181                       | C-CERAMIC,CHIP;100nF,+80-20%,25V,Y5V,TP, | .....5   | IC17     | 1209-001163                 | IC-PLL;TLC2932IPWLE,SOP,14P,-,PLASTIC         |  |
| .....5   | C50         | 2203-000357                       | C-CERAMIC,CHIP;0.15nF,5%,50V,NPO,TP,1608 | .....5   | L01      | 2701-001030                 | INDUCTOR-AXIAL;43uH,10%,5x14mm                |  |
| .....5   | C51         | 2203-001071                       | C-CERAMIC,CHIP;0.056nF,5%,50V,NPO,TP,160 | .....5   | OSC01    | 2804-001479                 | OSCILLATOR-CLOCK;24MHZ,100PPM,50PF,TP,5V      |  |
| .....5   | C52         | 2203-000041                       | C-CERAMIC,CHIP;0.01nF,0.25pF,50V,NPO,TP, | .....5   | PCB      | AA41-00717A                 | PCB-CONVERGENCE MODULE;HCM4215W,FR-4,4L,S.N.A |  |
| .....5   | C53         | 2203-000181                       | C-CERAMIC,CHIP;100nF,+80-20%,25V,Y5V,TP, | .....5   | Q02      | 0501-000280                 | TR-SMALL SIGNAL;KSA1182,PNP,150mW,SOT-23      |  |
| .....5   | C54         | 2203-000181                       | C-CERAMIC,CHIP;100nF,+80-20%,25V,Y5V,TP, | .....5   | Q03      | 0501-000280                 | TR-SMALL SIGNAL;KSA1182,PNP,150mW,SOT-23      |  |
| .....5   | C55         | 2203-000357                       | C-CERAMIC,CHIP;0.15nF,5%,50V,NPO,TP,1608 | .....5   | Q04      | 0501-000342                 | TR-SMALL SIGNAL;KSC1623-Y,NPN,200mW,SOT-      |  |
| .....5   | C56         | 2203-001071                       | C-CERAMIC,CHIP;0.056nF,5%,50V,NPO,TP,160 | .....5   | Q07      | 0505-000110                 | FET-SILICON;2N7002,N,60V,115MA,7.5OHM,0.      |  |
| .....5   | C57         | 2203-000041                       | C-CERAMIC,CHIP;0.01nF,0.25pF,50V,NPO,TP, | .....5   | Q08      | 0505-000110                 | FET-SILICON;2N7002,N,60V,115MA,7.5OHM,0.      |  |
| .....5   | C58         | 2203-000181                       | C-CERAMIC,CHIP;100nF,+80-20%,25V,Y5V,TP, | .....5   | Q09      | 0505-000110                 | FET-SILICON;2N7002,N,60V,115MA,7.5OHM,0.      |  |

| Loc. No. | Code No. | Description ; Specification | Remark                                   | Loc. No. | Code No.    | Description ; Specification         | Remark                                   |
|----------|----------|-----------------------------|--|----------|-------------|-------------------------------------|--|
| .....5   | Q10      | 0501-000342                 | TR-SMALL SIGNAL;KSC1623-Y,NPN,200mW,SOT- | .....5   | R56         | 2007-000078                         | R-CHIP;1Kohm,5%,1/16W,DA,TP;1608         |
| .....5   | R01      | 2007-000084                 | R-CHIP;4.7Kohm,5%,1/16W,DA,TP;1608       | .....5   | R57         | 2007-000080                         | R-CHIP;2Kohm,5%,1/16W,DA,TP;1608         |
| .....5   | R02      | 2007-000074                 | R-CHIP;100ohm,5%,1/16W,DA,TP;1608        | .....5   | R58         | 2007-000078                         | R-CHIP;1Kohm,5%,1/16W,DA,TP;1608         |
| .....5   | R03      | 2007-000078                 | R-CHIP;1Kohm,5%,1/16W,DA,TP;1608         | .....5   | R59         | 2007-000074                         | R-CHIP;100ohm,5%,1/16W,DA,TP;1608        |
| .....5   | R04      | 2007-000084                 | R-CHIP;4.7Kohm,5%,1/16W,DA,TP;1608       | .....5   | R60         | 2007-000084                         | R-CHIP;4.7Kohm,5%,1/16W,DA,TP;1608       |
| .....5   | R05      | 2007-000102                 | R-CHIP;100Kohm,5%,1/16W,DA,TP;1608       | .....5   | R61         | 2007-000084                         | R-CHIP;4.7Kohm,5%,1/16W,DA,TP;1608       |
| .....5   | R06      | 2007-000084                 | R-CHIP;4.7Kohm,5%,1/16W,DA,TP;1608       | .....5   | R62         | 2007-000078                         | R-CHIP;1Kohm,5%,1/16W,DA,TP;1608         |
| .....5   | R07      | 2007-000084                 | R-CHIP;4.7Kohm,5%,1/16W,DA,TP;1608       | .....5   | R63         | 2007-000080                         | R-CHIP;2Kohm,5%,1/16W,DA,TP;1608         |
| .....5   | R08      | 2007-000084                 | R-CHIP;4.7Kohm,5%,1/16W,DA,TP;1608       | .....5   | R64         | 2007-000078                         | R-CHIP;1Kohm,5%,1/16W,DA,TP;1608         |
| .....5   | R09      | 2007-000072                 | R-CHIP;47ohm,5%,1/16W,DA,TP;1608         | .....5   | R65         | 2007-000074                         | R-CHIP;100ohm,5%,1/16W,DA,TP;1608        |
| .....5   | R10      | 2007-000072                 | R-CHIP;47ohm,5%,1/16W,DA,TP;1608         | .....5   | R66         | 2007-000084                         | R-CHIP;4.7Kohm,5%,1/16W,DA,TP;1608       |
| .....5   | R100     | 2007-000125                 | R-CHIP;3.9Kohm,5%,1/16W,DA,TP;1608       | .....5   | R67         | 2007-000084                         | R-CHIP;4.7Kohm,5%,1/16W,DA,TP;1608       |
| .....5   | R101     | 2007-000090                 | R-CHIP;10KOHM,5%,1/16W,DA,TP;1608        | .....5   | R68         | 2007-000078                         | R-CHIP;1Kohm,5%,1/16W,DA,TP;1608         |
| .....5   | R107     | 2007-000122                 | R-CHIP;1.2Kohm,5%,1/16W,DA,TP;1608       | .....5   | R69         | 2007-000080                         | R-CHIP;2Kohm,5%,1/16W,DA,TP;1608         |
| .....5   | R108     | 2007-000381                 | R-CHIP;13Kohm,5%,1/16W,DA,TP;1608        | .....5   | R70         | 2007-000078                         | R-CHIP;1Kohm,5%,1/16W,DA,TP;1608         |
| .....5   | R109     | 2007-000082                 | R-CHIP;3.3Kohm,5%,1/16W,DA,TP;1608       | .....5   | R71         | 2007-000074                         | R-CHIP;100ohm,5%,1/16W,DA,TP;1608        |
| .....5   | R11      | 2007-000078                 | R-CHIP;1Kohm,5%,1/16W,DA,TP;1608         | .....5   | R72         | 2007-000084                         | R-CHIP;4.7Kohm,5%,1/16W,DA,TP;1608       |
| .....5   | R110     | 2007-000078                 | R-CHIP;1Kohm,5%,1/16W,DA,TP;1608         | .....5   | R73         | 2007-000084                         | R-CHIP;4.7Kohm,5%,1/16W,DA,TP;1608       |
| .....5   | R113     | 2007-000090                 | R-CHIP;10KOHM,5%,1/16W,DA,TP;1608        | .....5   | R74         | 2007-000078                         | R-CHIP;1Kohm,5%,1/16W,DA,TP;1608         |
| .....5   | R114     | 2007-000090                 | R-CHIP;10KOHM,5%,1/16W,DA,TP;1608        | .....5   | R75         | 2007-000080                         | R-CHIP;2Kohm,5%,1/16W,DA,TP;1608         |
| .....5   | R115     | 2007-000090                 | R-CHIP;10KOHM,5%,1/16W,DA,TP;1608        | .....5   | R76         | 2007-000078                         | R-CHIP;1Kohm,5%,1/16W,DA,TP;1608         |
| .....5   | R116     | 2007-001179                 | R-CHIP;8.2Kohm,5%,1/16W,DA,TP;1608       | .....5   | R77         | 2007-000074                         | R-CHIP;100ohm,5%,1/16W,DA,TP;1608        |
| .....5   | R117     | 2007-000122                 | R-CHIP;1.2Kohm,5%,1/16W,DA,TP;1608       | .....5   | R78         | 2007-000084                         | R-CHIP;4.7Kohm,5%,1/16W,DA,TP;1608       |
| .....5   | R118     | 2007-000084                 | R-CHIP;4.7Kohm,5%,1/16W,DA,TP;1608       | .....5   | R79         | 2007-000084                         | R-CHIP;4.7Kohm,5%,1/16W,DA,TP;1608       |
| .....5   | R119     | 2007-000084                 | R-CHIP;4.7Kohm,5%,1/16W,DA,TP;1608       | .....5   | R80         | 2007-000078                         | R-CHIP;1Kohm,5%,1/16W,DA,TP;1608         |
| .....5   | R120     | 2007-000124                 | R-CHIP;2.2Kohm,5%,1/16W,DA,TP;1608       | .....5   | R81         | 2007-000080                         | R-CHIP;2Kohm,5%,1/16W,DA,TP;1608         |
| .....5   | R121     | 2007-000084                 | R-CHIP;4.7Kohm,5%,1/16W,DA,TP;1608       | .....5   | R82         | 2007-000078                         | R-CHIP;1Kohm,5%,1/16W,DA,TP;1608         |
| .....5   | R122     | 2007-000070                 | R-CHIP;0ohm,5%,1/16W,DA,TP;1608          | .....5   | R87         | 2007-000757                         | R-CHIP;330KOHM,5%,1/10W,DA,TP;2012       |
| .....5   | R123     | 2007-000070                 | R-CHIP;0ohm,5%,1/16W,DA,TP;1608          | .....5   | R88         | 2007-000757                         | R-CHIP;330KOHM,5%,1/10W,DA,TP;2012       |
| .....5   | R125     | 2007-000355                 | R-CHIP;12KOHM,5%,1/10W,DA,TP;2012        | .....5   | R89         | 2007-000757                         | R-CHIP;330KOHM,5%,1/10W,DA,TP;2012       |
| .....5   | R126     | 2007-000856                 | R-CHIP;4.3KOHM,1%,1/10W,DA,TP;2012       | .....5   | R90         | 2007-000757                         | R-CHIP;330KOHM,5%,1/10W,DA,TP;2012       |
| .....5   | R127     | 2007-000109                 | R-CHIP;1Mohm,5%,1/16W,DA,TP;1608         | .....5   | R91         | 2007-000074                         | R-CHIP;100ohm,5%,1/16W,DA,TP;1608        |
| .....5   | R128     | 2007-000123                 | R-CHIP;1.5Kohm,5%,1/16W,DA,TP;1608       | .....5   | R92         | 2007-000090                         | R-CHIP;10KOHM,5%,1/16W,DA,TP;1608        |
| .....5   | R129     | 2007-000072                 | R-CHIP;47ohm,5%,1/16W,DA,TP;1608         | .....5   | R93         | 2007-000090                         | R-CHIP;10KOHM,5%,1/16W,DA,TP;1608        |
| .....5   | R133     | 2007-000084                 | R-CHIP;4.7Kohm,5%,1/16W,DA,TP;1608       | .....5   | R94         | 2007-000078                         | R-CHIP;1Kohm,5%,1/16W,DA,TP;1608         |
| .....5   | R134     | 2007-000072                 | R-CHIP;47ohm,5%,1/16W,DA,TP;1608         | .....5   | R95         | 2007-000704                         | R-CHIP;3.6Kohm,5%,1/16W,DA,TP;1608       |
| .....5   | R135     | 2007-000072                 | R-CHIP;47ohm,5%,1/16W,DA,TP;1608         | .....5   | R96         | 2007-000090                         | R-CHIP;10KOHM,5%,1/16W,DA,TP;1608        |
| .....5   | R136     | 2007-000072                 | R-CHIP;47ohm,5%,1/16W,DA,TP;1608         | .....5   | R97         | 2007-000090                         | R-CHIP;10KOHM,5%,1/16W,DA,TP;1608        |
| .....5   | R137     | 2007-000402                 | R-CHIP;150ohm,5%,1/16W,DA,TP;1608        | .....5   | R98         | 2007-000078                         | R-CHIP;1Kohm,5%,1/16W,DA,TP;1608         |
| .....5   | R138     | 2007-000402                 | R-CHIP;150ohm,5%,1/16W,DA,TP;1608        | .....5   | R99         | 2007-000704                         | R-CHIP;3.6Kohm,5%,1/16W,DA,TP;1608       |
| .....5   | R139     | 2007-000402                 | R-CHIP;150ohm,5%,1/16W,DA,TP;1608        | .....5   | RN01        | 2011-000585                         | R-NETWORK;47ohm,5%,63mW,L,CHIP;8P,TP     |
| .....5   | R15      | 2007-000072                 | R-CHIP;47ohm,5%,1/16W,DA,TP;1608         | .....5   | RN02        | 2011-000585                         | R-NETWORK;47ohm,5%,63mW,L,CHIP;8P,TP     |
| .....5   | R16      | 2007-000074                 | R-CHIP;100ohm,5%,1/16W,DA,TP;1608        | .....5   | RN03        | 2011-000585                         | R-NETWORK;47ohm,5%,63mW,L,CHIP;8P,TP     |
| .....5   | R17      | 2007-000074                 | R-CHIP;100ohm,5%,1/16W,DA,TP;1608        | .....5   | RN04        | 2011-000585                         | R-NETWORK;47ohm,5%,63mW,L,CHIP;8P,TP     |
| .....5   | R20      | 2007-000074                 | R-CHIP;100ohm,5%,1/16W,DA,TP;1608        | .....5   | RN05        | 2011-000585                         | R-NETWORK;47ohm,5%,63mW,L,CHIP;8P,TP     |
| .....5   | R24      | 2007-000072                 | R-CHIP;47ohm,5%,1/16W,DA,TP;1608         | .....5   | RN06        | 2011-000585                         | R-NETWORK;47ohm,5%,63mW,L,CHIP;8P,TP     |
| .....5   | R25      | 2007-000070                 | R-CHIP;0ohm,5%,1/16W,DA,TP;1608          | .....3   | AA95-03019A | ASSY SUB-PCB,PRO-SCAN;HCM4215W,P55A |  |
| .....5   | R26      | 2007-001167                 | R-CHIP;75ohm,5%,1/16W,DA,TP;1608         | .....4   | CN01        | 3703-001124                         | CONNECTOR-DIN;32P;2R,MALE,ANGLE,AUF      |
| .....5   | R27      | 2007-001167                 | R-CHIP;75ohm,5%,1/16W,DA,TP;1608         | .....4   | CN02        | 3703-001124                         | CONNECTOR-DIN;32P;2R,MALE,ANGLE,AUF      |
| .....5   | R28      | 2007-000122                 | R-CHIP;1.2Kohm,5%,1/16W,DA,TP;1608       | .....4   | CN03        | 3711-001164                         | CONNECTOR-HEADER;BOX;9P;1R,2.5mm,ANGLE,- |
| .....5   | R29      | 2007-000122                 | R-CHIP;1.2Kohm,5%,1/16W,DA,TP;1608       | .....4   | EX01        | 2801-004019                         | CRYSTAL-UNIT;20.25MHz,30ppm,28-AAM,13pF, |
| .....5   | R30      | 2007-000028                 | R-CHIP;390HM,5%,1/10W,DA,TP;2012         | .....4   | FC58        | 2309-000138                         | C-FILM,PE-PPF;100nF,5%,50V,TP;20x16x8.5, |
| .....5   | R31      | 2007-000028                 | R-CHIP;390HM,5%,1/10W,DA,TP;2012         | .....4   | FC59        | 2305-000704                         | C-FILM,MPEF;100nF,5%,250V,TP;16.5x10.3x5 |
| .....5   | R32      | 2007-000119                 | R-CHIP;560ohm,5%,1/16W,DA,TP;1608        | .....4   | FX01        | 2802-001177                         | RESONATOR-CERAMIC;2.696MHZ,0.4%,BK,10X4. |
| .....5   | R33      | 2007-000124                 | R-CHIP;2.2Kohm,5%,1/16W,DA,TP;1608       | .....4   | SX01        | 2802-001179                         | RESONATOR-CERAMIC;4MHZ,0.5%,BK,8X3X5.5MM |
| .....5   | R34      | 2007-000122                 | R-CHIP;1.2Kohm,5%,1/16W,DA,TP;1608       | .....4   | AA97-07660A | ASSY SMD;0, . . .                   |  |
| .....5   | R35      | 2007-000028                 | R-CHIP;390HM,5%,1/10W,DA,TP;2012         | .....5   | CC49        | 2402-001070                         | C-AL,SMD;470uF,20%,16V,GP,TP;10x10.2,-   |
| .....5   | R36      | 2007-000028                 | R-CHIP;390HM,5%,1/10W,DA,TP;2012         | .....5   | CLO7        | 2703-000398                         | INDUCTOR-SMD;10uH,10%,3.2x2.5x2.2mm      |
| .....5   | R37      | 2007-000078                 | R-CHIP;1Kohm,5%,1/16W,DA,TP;1608         | .....5   | CR83        | 2007-000074                         | R-CHIP;100ohm,5%,1/16W,DA,TP;1608        |
| .....5   | R38      | 2007-000078                 | R-CHIP;1Kohm,5%,1/16W,DA,TP;1608         | .....5   | CR84        | 2007-000074                         | R-CHIP;100ohm,5%,1/16W,DA,TP;1608        |
| .....5   | R39      | 2007-000078                 | R-CHIP;1Kohm,5%,1/16W,DA,TP;1608         | .....5   | EC01        | 2203-000181                         | C-CERAMIC,CHIP;100nF,+80-20%,25V,Y5V,TP, |
| .....5   | R40      | 2007-000078                 | R-CHIP;1Kohm,5%,1/16W,DA,TP;1608         | .....5   | EC02        | 2203-000181                         | C-CERAMIC,CHIP;100nF,+80-20%,25V,Y5V,TP, |
| .....5   | R41      | 2007-000078                 | R-CHIP;1Kohm,5%,1/16W,DA,TP;1608         | .....5   | EC03        | 2203-000181                         | C-CERAMIC,CHIP;100nF,+80-20%,25V,Y5V,TP, |
| .....5   | R42      | 2007-000078                 | R-CHIP;1Kohm,5%,1/16W,DA,TP;1608         | .....5   | EC04        | 2203-000181                         | C-CERAMIC,CHIP;100nF,+80-20%,25V,Y5V,TP, |
| .....5   | R43      | 2007-000078                 | R-CHIP;1Kohm,5%,1/16W,DA,TP;1608         | .....5   | EC07        | 2203-000975                         | C-CERAMIC,CHIP;47nF,10%,25V,X7R,TP;1608, |
| .....5   | R44      | 2007-000078                 | R-CHIP;1Kohm,5%,1/16W,DA,TP;1608         | .....5   | EC09        | 2203-000575                         | C-CERAMIC,CHIP;220NF,10%,25V,X7R,TP;2012 |
| .....5   | R45      | 2007-000072                 | R-CHIP;47ohm,5%,1/16W,DA,TP;1608         | .....5   | EC10        | 2203-000575                         | C-CERAMIC,CHIP;220NF,10%,25V,X7R,TP;2012 |
| .....5   | R46      | 2007-000072                 | R-CHIP;47ohm,5%,1/16W,DA,TP;1608         | .....5   | EC11        | 2203-000575                         | C-CERAMIC,CHIP;220NF,10%,25V,X7R,TP;2012 |
| .....5   | R47      | 2007-000074                 | R-CHIP;100ohm,5%,1/16W,DA,TP;1608        | .....5   | EC12        | 2203-000181                         | C-CERAMIC,CHIP;100nF,+80-20%,25V,Y5V,TP, |
| .....5   | R48      | 2007-000084                 | R-CHIP;4.7Kohm,5%,1/16W,DA,TP;1608       | .....5   | EC13        | 2203-000181                         | C-CERAMIC,CHIP;100nF,+80-20%,25V,Y5V,TP, |
| .....5   | R49      | 2007-000084                 | R-CHIP;4.7Kohm,5%,1/16W,DA,TP;1608       | .....5   | EC14        | 2203-000975                         | C-CERAMIC,CHIP;47nF,10%,25V,X7R,TP;1608, |
| .....5   | R50      | 2007-000078                 | R-CHIP;1Kohm,5%,1/16W,DA,TP;1608         | .....5   | EC15        | 2203-000975                         | C-CERAMIC,CHIP;47nF,10%,25V,X7R,TP;1608, |
| .....5   | R51      | 2007-000080                 | R-CHIP;2Kohm,5%,1/16W,DA,TP;1608         | .....5   | EC16        | 2203-000975                         | C-CERAMIC,CHIP;47nF,10%,25V,X7R,TP;1608, |
| .....5   | R52      | 2007-000078                 | R-CHIP;1Kohm,5%,1/16W,DA,TP;1608         | .....5   | EC17        | 2203-000181                         | C-CERAMIC,CHIP;100nF,+80-20%,25V,Y5V,TP, |
| .....5   | R53      | 2007-000074                 | R-CHIP;100ohm,5%,1/16W,DA,TP;1608        | .....5   | EC18        | 2203-000975                         | C-CERAMIC,CHIP;47nF,10%,25V,X7R,TP;1608, |
| .....5   | R54      | 2007-000084                 | R-CHIP;4.7Kohm,5%,1/16W,DA,TP;1608       | .....5   | EC19        | 2203-000975                         | C-CERAMIC,CHIP;47nF,10%,25V,X7R,TP;1608, |
| .....5   | R55      | 2007-000084                 | R-CHIP;4.7Kohm,5%,1/16W,DA,TP;1608       | .....5   | EC20        | 2203-000975                         | C-CERAMIC,CHIP;47nF,10%,25V,X7R,TP;1608, |

Electrical Parts List

| Loc. No. | Code No. | Description ; Specification                          | Remark | Loc. No. | Code No. | Description ; Specification                          | Remark |
|----------|----------|--|--------|----------|----------|--|--------|
| .....5   | EC21     | 2203-000975 C-CERAMIC,CHIP;47nF,10%,25V,X7R,TP,1608, |        | .....5   | FC08     | 2203-002494 C-CERAMIC,CHIP;470nF,10%,16V,X7R,TP,2012 |        |
| .....5   | EC22     | 2203-000975 C-CERAMIC,CHIP;47nF,10%,25V,X7R,TP,1608, |        | .....5   | FC09     | 2402-000170 C-AL,SMD;1uF,20%,50V,GP,TP,4.3x4.3x5.4,  |        |
| .....5   | EC23     | 2203-000975 C-CERAMIC,CHIP;47nF,10%,25V,X7R,TP,1608, |        | .....5   | FC10     | 2203-000181 C-CERAMIC,CHIP;100nF,+80-20%,25V,Y5V,TP, |        |
| .....5   | EC24     | 2203-000975 C-CERAMIC,CHIP;47nF,10%,25V,X7R,TP,1608, |        | .....5   | FC11     | 2203-000181 C-CERAMIC,CHIP;100nF,+80-20%,25V,Y5V,TP, |        |
| .....5   | EC25     | 2203-000181 C-CERAMIC,CHIP;100nF,+80-20%,25V,Y5V,TP, |        | .....5   | FC12     | 2402-001042 C-AL,SMD;100uF,20%,16V,GP,TP,6.6x6.6x5.4 |        |
| .....5   | EC27     | 2203-000784 C-CERAMIC,CHIP;0.33nF,5%,50V,NPO,TP,2012 |        | .....5   | FC21     | 2203-000181 C-CERAMIC,CHIP;100nF,+80-20%,25V,Y5V,TP, |        |
| .....5   | EC30     | 2007-001166 R-CHIP;750HM,5%,1/10W,DA,TP,2012         |        | .....5   | FC22     | 2203-000181 C-CERAMIC,CHIP;100nF,+80-20%,25V,Y5V,TP, |        |
| .....5   | EC31     | 2007-001166 R-CHIP;750HM,5%,1/10W,DA,TP,2012         |        | .....5   | FC23     | 2203-000181 C-CERAMIC,CHIP;100nF,+80-20%,25V,Y5V,TP, |        |
| .....5   | EC32     | 2203-005384 C-CERAMIC,CHIP;4700nF,+80-20%,10V,Y5V,TP |        | .....5   | FC24     | 2203-000181 C-CERAMIC,CHIP;100nF,+80-20%,25V,Y5V,TP, |        |
| .....5   | EC33     | 2203-005384 C-CERAMIC,CHIP;4700nF,+80-20%,10V,Y5V,TP |        | .....5   | FC25     | 2203-000181 C-CERAMIC,CHIP;100nF,+80-20%,25V,Y5V,TP, |        |
| .....5   | EC34     | 2203-005384 C-CERAMIC,CHIP;4700nF,+80-20%,10V,Y5V,TP |        | .....5   | FC26     | 2203-000181 C-CERAMIC,CHIP;100nF,+80-20%,25V,Y5V,TP, |        |
| .....5   | EC35     | 2203-000681 C-CERAMIC,CHIP;0.027nF,5%,50V,NPO,TP,160 |        | .....5   | FC27     | 2203-002494 C-CERAMIC,CHIP;470nF,10%,16V,X7R,TP,2012 |        |
| .....5   | EC36     | 2203-000681 C-CERAMIC,CHIP;0.027nF,5%,50V,NPO,TP,160 |        | .....5   | FC28     | 2203-002494 C-CERAMIC,CHIP;470nF,10%,16V,X7R,TP,2012 |        |
| .....5   | EC37     | 2203-000681 C-CERAMIC,CHIP;0.027nF,5%,50V,NPO,TP,160 |        | .....5   | FC29     | 2402-000173 C-AL,SMD;4.7uF,20%,35V,GP,TP,4.3x4.3x5.  |        |
| .....5   | EC61     | 2203-000181 C-CERAMIC,CHIP;100nF,+80-20%,25V,Y5V,TP, |        | .....5   | FC30     | 2203-000181 C-CERAMIC,CHIP;100nF,+80-20%,25V,Y5V,TP, |        |
| .....5   | EC62     | 2203-000181 C-CERAMIC,CHIP;100nF,+80-20%,25V,Y5V,TP, |        | .....5   | FC31     | 2402-001070 C-AL,SMD;470uF,20%,16V,GP,TP,10x10.2,-   |        |
| .....5   | EC63     | 2203-000626 C-CERAMIC,CHIP;0.022nF,5%,50V,NPO,TP,160 |        | .....5   | FC32     | 2203-000181 C-CERAMIC,CHIP;100nF,+80-20%,25V,Y5V,TP, |        |
| .....5   | EC64     | 2203-000626 C-CERAMIC,CHIP;0.022nF,5%,50V,NPO,TP,160 |        | .....5   | FC41     | 2203-000181 C-CERAMIC,CHIP;100nF,+80-20%,25V,Y5V,TP, |        |
| .....5   | EC65     | 2203-000181 C-CERAMIC,CHIP;100nF,+80-20%,25V,Y5V,TP, |        | .....5   | FC42     | 2203-000181 C-CERAMIC,CHIP;100nF,+80-20%,25V,Y5V,TP, |        |
| .....5   | EC66     | 2203-000181 C-CERAMIC,CHIP;100nF,+80-20%,25V,Y5V,TP, |        | .....5   | FC43     | 2203-000181 C-CERAMIC,CHIP;100nF,+80-20%,25V,Y5V,TP, |        |
| .....5   | EC67     | 2203-000181 C-CERAMIC,CHIP;100nF,+80-20%,25V,Y5V,TP, |        | .....5   | FC44     | 2203-000181 C-CERAMIC,CHIP;100nF,+80-20%,25V,Y5V,TP, |        |
| .....5   | EC68     | 2203-000181 C-CERAMIC,CHIP;100nF,+80-20%,25V,Y5V,TP, |        | .....5   | FC45     | 2402-001042 C-AL,SMD;100uF,20%,16V,GP,TP,6.6x6.6x5.4 |        |
| .....5   | EC69     | 2203-000181 C-CERAMIC,CHIP;100nF,+80-20%,25V,Y5V,TP, |        | .....5   | FC46     | 2203-002494 C-CERAMIC,CHIP;470nF,10%,16V,X7R,TP,2012 |        |
| .....5   | EC70     | 2203-000181 C-CERAMIC,CHIP;100nF,+80-20%,25V,Y5V,TP, |        | .....5   | FC47     | 2203-000575 C-CERAMIC,CHIP;220NF,10%,25V,X7R,TP,2012 |        |
| .....5   | EL01     | 2703-000274 INDUCTOR-SMD;2.2uH,10%,1.25x2x0.85mm     |        | .....5   | FC48     | 2203-002494 C-CERAMIC,CHIP;470nF,10%,16V,X7R,TP,2012 |        |
| .....5   | EL02     | 2703-000274 INDUCTOR-SMD;2.2uH,10%,1.25x2x0.85mm     |        | .....5   | FC49     | 2203-000891 C-CERAMIC,CHIP;4.7nF,10%,50V,X7R,TP,2012 |        |
| .....5   | EL03     | 2703-000274 INDUCTOR-SMD;2.2uH,10%,1.25x2x0.85mm     |        | .....5   | FC50     | 2203-001680 C-CERAMIC,CHIP;68nF,20%,50V,Z5U,TP,2012  |        |
| .....5   | EL04     | 2703-000274 INDUCTOR-SMD;2.2uH,10%,1.25x2x0.85mm     |        | .....5   | FC52     | 2203-000206 C-CERAMIC,CHIP;100nF,10%,50V,X7R,TP,2012 |        |
| .....5   | EL05     | 2703-000274 INDUCTOR-SMD;2.2uH,10%,1.25x2x0.85mm     |        | .....5   | FC53     | 2203-000206 C-CERAMIC,CHIP;100nF,10%,50V,X7R,TP,2012 |        |
| .....5   | EL06     | 2703-000274 INDUCTOR-SMD;2.2uH,10%,1.25x2x0.85mm     |        | .....5   | FC54     | 2203-000257 C-CERAMIC,CHIP;100nF,10%,50V,X7R,TP,1608 |        |
| .....5   | EL07     | 2703-000274 INDUCTOR-SMD;2.2uH,10%,1.25x2x0.85mm     |        | .....5   | FC55     | 2203-000181 C-CERAMIC,CHIP;100nF,+80-20%,25V,Y5V,TP, |        |
| .....5   | EL08     | 2703-000274 INDUCTOR-SMD;2.2uH,10%,1.25x2x0.85mm     |        | .....5   | FC57     | 2203-000440 C-CERAMIC,CHIP;1nF,10%,50V,X7R,TP,1608,- |        |
| .....5   | EL09     | 3301-001324 CORE-FERRITE BEAD;AB,150HM,2X1.25X0.9MM, |        | .....5   | FC60     | 2402-000173 C-AL,SMD;4.7uF,20%,35V,GP,TP,4.3x4.3x5.  |        |
| .....5   | EQ11     | 0505-000110 FET-SILICON;2N7002,N,60V,115MA,7.50HM,0. |        | .....5   | FC61     | 2203-000181 C-CERAMIC,CHIP;100nF,+80-20%,25V,Y5V,TP, |        |
| .....5   | EQ12     | 0505-000110 FET-SILICON;2N7002,N,60V,115MA,7.50HM,0. |        | .....5   | FC62     | 2402-001042 C-AL,SMD;100uF,20%,16V,GP,TP,6.6x6.6x5.4 |        |
| .....5   | EQ13     | 0501-000344 TR-SMALL SIGNAL;KSC1623-G,NPN,200mW,SOT- |        | .....5   | FC63     | 2402-001042 C-AL,SMD;100uF,20%,16V,GP,TP,6.6x6.6x5.4 |        |
| .....5   | EQ14     | 0501-000344 TR-SMALL SIGNAL;KSC1623-G,NPN,200mW,SOT- |        | .....5   | FC64     | 2203-000181 C-CERAMIC,CHIP;100nF,+80-20%,25V,Y5V,TP, |        |
| .....5   | EQ15     | 0501-000344 TR-SMALL SIGNAL;KSC1623-G,NPN,200mW,SOT- |        | .....5   | FC65     | 2402-001049 C-AL,CHIP;10uF,20%,16V,GP,TP,3.3x3.3x5.4 |        |
| .....5   | ER03     | 2007-001166 R-CHIP;750HM,5%,1/10W,DA,TP,2012         |        | .....5   | FD01     | 0401-000133 DIODE-SWITCHING;RLS4148,100V,200MA,SOD-8 |        |
| .....5   | ER04     | 2007-000070 R-CHIP;0ohm,5%,1/16W,DA,TP,1608          |        | .....5   | FD02     | 0401-000133 DIODE-SWITCHING;RLS4148,100V,200MA,SOD-8 |        |
| .....5   | ER05     | 2007-000070 R-CHIP;0ohm,5%,1/16W,DA,TP,1608          |        | .....5   | FD03     | 0403-001117 DIODE-ZENER;RLZ12B,5%,500mW,LL-34,TP     |        |
| .....5   | ER06     | 2007-000070 R-CHIP;0ohm,5%,1/16W,DA,TP,1608          |        | .....5   | FD04     | 0403-001117 DIODE-ZENER;RLZ12B,5%,500mW,LL-34,TP     |        |
| .....5   | ER08     | 2007-000290 R-CHIP;100OHM,5%,1/10W,DA,TP,2012        |        | .....5   | FD05     | 0403-001117 DIODE-ZENER;RLZ12B,5%,500mW,LL-34,TP     |        |
| .....5   | ER09     | 2007-001166 R-CHIP;750HM,5%,1/10W,DA,TP,2012         |        | .....5   | FD06     | 0403-001117 DIODE-ZENER;RLZ12B,5%,500mW,LL-34,TP     |        |
| .....5   | ER10     | 2007-001166 R-CHIP;750HM,5%,1/10W,DA,TP,2012         |        | .....5   | FD07     | 0401-000133 DIODE-SWITCHING;RLS4148,100V,200MA,SOD-8 |        |
| .....5   | ER11     | 2007-001166 R-CHIP;750HM,5%,1/10W,DA,TP,2012         |        | .....5   | FD08     | 0401-000133 DIODE-SWITCHING;RLS4148,100V,200MA,SOD-8 |        |
| .....5   | ER12     | 2007-001166 R-CHIP;750HM,5%,1/10W,DA,TP,2012         |        | .....5   | FD09     | 0401-000133 DIODE-SWITCHING;RLS4148,100V,200MA,SOD-8 |        |
| .....5   | ER13     | 2007-000070 R-CHIP;0ohm,5%,1/16W,DA,TP,1608          |        | .....5   | FD10     | 0401-000133 DIODE-SWITCHING;RLS4148,100V,200MA,SOD-8 |        |
| .....5   | ER14     | 2007-001166 R-CHIP;750HM,5%,1/10W,DA,TP,2012         |        | .....5   | FD11     | 0403-001016 DIODE-ZENER;RLZ6.2B,6.2V,5.96-6.27V,400m |        |
| .....5   | ER15     | 2007-000290 R-CHIP;100OHM,5%,1/10W,DA,TP,2012        |        | .....5   | FD12     | 0403-000746 DIODE-ZENER;RLZ3.9B,3.9V,3.89-4.16V,400m |        |
| .....5   | ER16     | 2007-000290 R-CHIP;100OHM,5%,1/10W,DA,TP,2012        |        | .....5   | FD13     | 0401-000133 DIODE-SWITCHING;RLS4148,100V,200MA,SOD-8 |        |
| .....5   | ER17     | 2007-000070 R-CHIP;0ohm,5%,1/16W,DA,TP,1608          |        | .....5   | FD14     | 0401-000133 DIODE-SWITCHING;RLS4148,100V,200MA,SOD-8 |        |
| .....5   | ER18     | 2007-000070 R-CHIP;0ohm,5%,1/16W,DA,TP,1608          |        | .....5   | FD15     | 0401-000133 DIODE-SWITCHING;RLS4148,100V,200MA,SOD-8 |        |
| .....5   | ER19     | 2007-000070 R-CHIP;0ohm,5%,1/16W,DA,TP,1608          |        | .....5   | FD16     | 0401-000133 DIODE-SWITCHING;RLS4148,100V,200MA,SOD-8 |        |
| .....5   | ER20     | 2007-000097 R-CHIP;47Kohm,5%,1/16W,DA,TP,1608        |        | .....5   | FD17     | 0401-000133 DIODE-SWITCHING;RLS4148,100V,200MA,SOD-8 |        |
| .....5   | ER21     | 2007-000097 R-CHIP;47Kohm,5%,1/16W,DA,TP,1608        |        | .....5   | FL01     | 2703-001070 INDUCTOR-SMD;100uH,10%,4.5x3.2x3.2mm     |        |
| .....5   | ER22     | 2007-000097 R-CHIP;47Kohm,5%,1/16W,DA,TP,1608        |        | .....5   | FQ02     | 0501-000280 TR-SMALL SIGNAL;KSA1182,PNP,150mW,SOT-23 |        |
| .....5   | ER23     | 2007-000097 R-CHIP;47Kohm,5%,1/16W,DA,TP,1608        |        | .....5   | FQ03     | 0501-000280 TR-SMALL SIGNAL;KSA1182,PNP,150mW,SOT-23 |        |
| .....5   | ER24     | 2007-000097 R-CHIP;47Kohm,5%,1/16W,DA,TP,1608        |        | .....5   | FQ04     | 0501-000280 TR-SMALL SIGNAL;KSA1182,PNP,150mW,SOT-23 |        |
| .....5   | ER25     | 2007-000097 R-CHIP;47Kohm,5%,1/16W,DA,TP,1608        |        | .....5   | FQ05     | 0501-000344 TR-SMALL SIGNAL;KSC1623-G,NPN,200mW,SOT- |        |
| .....5   | ER26     | 2007-000931 R-CHIP;470OHM,5%,1/10W,DA,TP,2012        |        | .....5   | FQ06     | 0501-000344 TR-SMALL SIGNAL;KSC1623-G,NPN,200mW,SOT- |        |
| .....5   | ER27     | 2007-000931 R-CHIP;470OHM,5%,1/10W,DA,TP,2012        |        | .....5   | FQ07     | 0501-000727 TR-SMALL SIGNAL;BC848C,NPN,310mW,SOT-23  |        |
| .....5   | ER28     | 2007-000931 R-CHIP;470OHM,5%,1/10W,DA,TP,2012        |        | .....5   | FQ08     | 0501-000344 TR-SMALL SIGNAL;KSC1623-G,NPN,200mW,SOT- |        |
| .....5   | ER29     | 2007-000070 R-CHIP;0ohm,5%,1/16W,DA,TP,1608          |        | .....5   | FQ09     | 0501-000344 TR-SMALL SIGNAL;KSC1623-G,NPN,200mW,SOT- |        |
| .....5   | ER82     | 2007-000074 R-CHIP;100ohm,5%,1/16W,DA,TP,1608        |        | .....5   | FQ12     | 0501-000344 TR-SMALL SIGNAL;KSC1623-G,NPN,200mW,SOT- |        |
| .....5   | ER83     | 2007-000074 R-CHIP;100ohm,5%,1/16W,DA,TP,1608        |        | .....5   | FQ13     | 0501-000280 TR-SMALL SIGNAL;KSA1182,PNP,150mW,SOT-23 |        |
| .....5   | ER84     | 2007-000074 R-CHIP;100ohm,5%,1/16W,DA,TP,1608        |        | .....5   | FR01     | 2007-000074 R-CHIP;100ohm,5%,1/16W,DA,TP,1608        |        |
| .....5   | ER90     | 2007-000029 R-CHIP;0OHM,5%,1/10W,DA,TP,2012          |        | .....5   | FR02     | 2007-000074 R-CHIP;100ohm,5%,1/16W,DA,TP,1608        |        |
| .....5   | ER91     | 2007-000084 R-CHIP;4.7Kohm,5%,1/16W,DA,TP,1608       |        | .....5   | FR03     | 2007-000074 R-CHIP;100ohm,5%,1/16W,DA,TP,1608        |        |
| .....5   | ER92     | 2007-000084 R-CHIP;4.7Kohm,5%,1/16W,DA,TP,1608       |        | .....5   | FR07     | 2007-000070 R-CHIP;0ohm,5%,1/16W,DA,TP,1608          |        |
| .....5   | FC01     | 2203-000440 C-CERAMIC,CHIP;1nF,10%,50V,X7R,TP,1608,- |        | .....5   | FR08     | 2007-000074 R-CHIP;100ohm,5%,1/16W,DA,TP,1608        |        |
| .....5   | FC02     | 2203-000440 C-CERAMIC,CHIP;1nF,10%,50V,X7R,TP,1608,- |        | .....5   | FR09     | 2007-000090 R-CHIP;10KOHM,5%,1/16W,DA,TP,1608        |        |
| .....5   | FC03     | 2203-000181 C-CERAMIC,CHIP;100nF,+80-20%,25V,Y5V,TP, |        | .....5   | FR10     | 2007-000210 R-CHIP;1.1KOHM,5%,1/10W,DA,TP,2012       |        |
| .....5   | FC04     | 2402-001042 C-AL,SMD;100uF,20%,16V,GP,TP,6.6x6.6x5.4 |        | .....5   | FR11     | 2007-000210 R-CHIP;1.1KOHM,5%,1/10W,DA,TP,2012       |        |
| .....5   | FC05     | 2203-000181 C-CERAMIC,CHIP;100nF,+80-20%,25V,Y5V,TP, |        | .....5   | FR12     | 2007-000210 R-CHIP;1.1KOHM,5%,1/10W,DA,TP,2012       |        |
| .....5   | FC06     | 2402-001049 C-AL,CHIP;10uF,20%,16V,GP,TP,3.3x3.3x5.4 |        | .....5   | FR13     | 2007-000210 R-CHIP;1.1KOHM,5%,1/10W,DA,TP,2012       |        |
| .....5   | FC07     | 2203-000491 C-CERAMIC,CHIP;2.2nF,10%,50V,X7R,TP,1608 |        | .....5   | FR14     | 2007-000210 R-CHIP;1.1KOHM,5%,1/10W,DA,TP,2012       |        |

| Loc. No. | Code No. | Description ; Specification | Remark                                   | Loc. No. | Code No. | Description ; Specification | Remark   |
|----------|----------|-----------------------------|--|----------|----------|-----------------------------|--|
| .....    | FR15     | 2007-000210                 | R-CHIP;1.1KOHM,5%,1/10W,DA,TP,2012       | .....    | PC18     | 2402-000173                 | C-AL,SMD;4.7uF,20%,35V,GP,TP,4.3x4.3x5.        |
| .....    | FR16     | 2007-000074                 | R-CHIP;100ohm,5%,1/16W,DA,TP,1608        | .....    | PC31     | 2203-000181                 | C-CERAMIC,CHIP;100nF,+80-20%,25V,Y5V,TP,       |
| .....    | FR17     | 2007-000074                 | R-CHIP;100ohm,5%,1/16W,DA,TP,1608        | .....    | PC32     | 2402-000179                 | C-AL,SMD;47uF,20%,16V,GP,TP,6.6x6.6x5.4        |
| .....    | FR18     | 2007-000074                 | R-CHIP;100ohm,5%,1/16W,DA,TP,1608        | .....    | PCB      | AA41-00610A                 | PCB-DW-SRC,-FR-4,4L,A,1.6T,180X245,2A,14 S.N.A |
| .....    | FR19     | 2007-000074                 | R-CHIP;100ohm,5%,1/16W,DA,TP,1608        | .....    | PL01     | 3301-001082                 | CORE-FERRITE BEAD;AB,600HM,3.2X2.5X1.3MM       |
| .....    | FR20     | 2007-000074                 | R-CHIP;100ohm,5%,1/16W,DA,TP,1608        | .....    | PL02     | 3301-001324                 | CORE-FERRITE BEAD;AB,150HM,2X1.25X0.9MM,       |
| .....    | FR21     | 2007-000074                 | R-CHIP;100ohm,5%,1/16W,DA,TP,1608        | .....    | PL03     | 3301-001324                 | CORE-FERRITE BEAD;AB,150HM,2X1.25X0.9MM,       |
| .....    | FR22     | 2007-000090                 | R-CHIP;10KOHM,5%,1/16W,DA,TP,1608        | .....    | PL04     | 3301-001324                 | CORE-FERRITE BEAD;AB,150HM,2X1.25X0.9MM,       |
| .....    | FR31     | 2007-000074                 | R-CHIP;100ohm,5%,1/16W,DA,TP,1608        | .....    | PL05     | 3301-001324                 | CORE-FERRITE BEAD;AB,150HM,2X1.25X0.9MM,       |
| .....    | FR32     | 2007-000074                 | R-CHIP;100ohm,5%,1/16W,DA,TP,1608        | .....    | PL06     | 3301-001324                 | CORE-FERRITE BEAD;AB,150HM,2X1.25X0.9MM,       |
| .....    | FR33     | 2007-000074                 | R-CHIP;100ohm,5%,1/16W,DA,TP,1608        | .....    | PL07     | 3301-001186                 | CORE-FERRITE BEAD;AB,600ohm,3.2x1.6x1.3m       |
| .....    | FR34     | 2007-000074                 | R-CHIP;100ohm,5%,1/16W,DA,TP,1608        | .....    | PL08     | 3301-001186                 | CORE-FERRITE BEAD;AB,600ohm,3.2x1.6x1.3m       |
| .....    | FR35     | 2007-000070                 | R-CHIP;0ohm,5%,1/16W,DA,TP,1608          | .....    | PO01     | 0501-000344                 | TR-SMALL SIGNAL;KSC1623-G,NPN,200mW,SOT-       |
| .....    | FR36     | 2007-000691                 | R-CHIP;3.3Mohm,5%,1/16W,DA,TP,1608       | .....    | PRO1     | 2007-000090                 | R-CHIP;10KOHM,5%,1/16W,DA,TP,1608              |
| .....    | FR37     | 2007-000074                 | R-CHIP;100ohm,5%,1/16W,DA,TP,1608        | .....    | PRO2     | 2007-000097                 | R-CHIP;47Kohm,5%,1/16W,DA,TP,1608              |
| .....    | FR38     | 2007-000074                 | R-CHIP;100ohm,5%,1/16W,DA,TP,1608        | .....    | SC01     | 2203-002494                 | C-CERAMIC,CHIP;470nF,10%,16V,X7R,TP,2012       |
| .....    | FR39     | 2007-000074                 | R-CHIP;100ohm,5%,1/16W,DA,TP,1608        | .....    | SC02     | 2203-002494                 | C-CERAMIC,CHIP;470nF,10%,16V,X7R,TP,2012       |
| .....    | FR40     | 2007-000080                 | R-CHIP;2Kohm,5%,1/16W,DA,TP,1608         | .....    | SC03     | 2203-002494                 | C-CERAMIC,CHIP;470nF,10%,16V,X7R,TP,2012       |
| .....    | FR41     | 2007-000086                 | R-CHIP;5.6Kohm,5%,1/16W,DA,TP,1608       | .....    | SC04     | 2203-002494                 | C-CERAMIC,CHIP;470nF,10%,16V,X7R,TP,2012       |
| .....    | FR42     | 2007-000086                 | R-CHIP;5.6Kohm,5%,1/16W,DA,TP,1608       | .....    | SC05     | 2203-002494                 | C-CERAMIC,CHIP;470nF,10%,16V,X7R,TP,2012       |
| .....    | FR43     | 2007-000869                 | R-CHIP;4.7Kohm,1%,1/16W,DA,TP,1608       | .....    | SC06     | 2203-002494                 | C-CERAMIC,CHIP;470nF,10%,16V,X7R,TP,2012       |
| .....    | FR44     | 2007-000084                 | R-CHIP;4.7Kohm,5%,1/16W,DA,TP,1608       | .....    | SC07     | 2203-002494                 | C-CERAMIC,CHIP;470nF,10%,16V,X7R,TP,2012       |
| .....    | FR45     | 2007-000084                 | R-CHIP;4.7Kohm,5%,1/16W,DA,TP,1608       | .....    | SC08     | 2203-002494                 | C-CERAMIC,CHIP;470nF,10%,16V,X7R,TP,2012       |
| .....    | FR46     | 2007-000493                 | R-CHIP;2.2KOHM,5%,1/10W,DA,TP,2012       | .....    | SC09     | 2203-002494                 | C-CERAMIC,CHIP;470nF,10%,16V,X7R,TP,2012       |
| .....    | FR47     | 2007-000493                 | R-CHIP;2.2KOHM,5%,1/10W,DA,TP,2012       | .....    | SC10     | 2203-002494                 | C-CERAMIC,CHIP;470nF,10%,16V,X7R,TP,2012       |
| .....    | FR53     | 2007-000074                 | R-CHIP;100ohm,5%,1/16W,DA,TP,1608        | .....    | SC11     | 2402-000179                 | C-AL,SMD;47uF,20%,16V,GP,TP,6.6x6.6x5.4        |
| .....    | FR54     | 2007-000074                 | R-CHIP;100ohm,5%,1/16W,DA,TP,1608        | .....    | SC12     | 2203-000181                 | C-CERAMIC,CHIP;100nF,+80-20%,25V,Y5V,TP,       |
| .....    | FR55     | 2007-000074                 | R-CHIP;100ohm,5%,1/16W,DA,TP,1608        | .....    | SC13     | 2203-000257                 | C-CERAMIC,CHIP;10nF,10%,50V,X7R,TP,1608        |
| .....    | FR56     | 2007-000074                 | R-CHIP;100ohm,5%,1/16W,DA,TP,1608        | .....    | SC14     | 2203-005809                 | C-CERAMIC,CHIP;1000nF,10%,16V,X7R,TP,201       |
| .....    | FR57     | 2007-000052                 | R-CHIP;10Kohm,1%,1/16W,DA,TP,1608        | .....    | SC15     | 2203-000181                 | C-CERAMIC,CHIP;100nF,+80-20%,25V,Y5V,TP,       |
| .....    | FR58     | 2007-000092                 | R-CHIP;15Kohm,5%,1/16W,DA,TP,1608        | .....    | SC16     | 2402-000179                 | C-AL,SMD;47uF,20%,16V,GP,TP,6.6x6.6x5.4        |
| .....    | FR60     | 2007-000090                 | R-CHIP;10KOHM,5%,1/16W,DA,TP,1608        | .....    | SC17     | 2203-000181                 | C-CERAMIC,CHIP;100nF,+80-20%,25V,Y5V,TP,       |
| .....    | FR62     | 2007-000082                 | R-CHIP;3.3Kohm,5%,1/16W,DA,TP,1608       | .....    | SC18     | 2402-000179                 | C-AL,SMD;47uF,20%,16V,GP,TP,6.6x6.6x5.4        |
| .....    | FR63     | 2007-000118                 | R-CHIP;390ohm,5%,1/16W,DA,TP,1608        | .....    | SC19     | 2203-000181                 | C-CERAMIC,CHIP;100nF,+80-20%,25V,Y5V,TP,       |
| .....    | FR66     | 2007-000077                 | R-CHIP;470ohm,5%,1/16W,DA,TP,1608        | .....    | SC20     | 2203-002494                 | C-CERAMIC,CHIP;470nF,10%,16V,X7R,TP,2012       |
| .....    | FR67     | 2007-000074                 | R-CHIP;100ohm,5%,1/16W,DA,TP,1608        | .....    | SC21     | 2203-002494                 | C-CERAMIC,CHIP;470nF,10%,16V,X7R,TP,2012       |
| .....    | FR70     | 2007-000124                 | R-CHIP;2.2Kohm,5%,1/16W,DA,TP,1608       | .....    | SC22     | 2203-002494                 | C-CERAMIC,CHIP;470nF,10%,16V,X7R,TP,2012       |
| .....    | FR71     | 2007-000074                 | R-CHIP;100ohm,5%,1/16W,DA,TP,1608        | .....    | SC23     | 2203-002494                 | C-CERAMIC,CHIP;470nF,10%,16V,X7R,TP,2012       |
| .....    | FR72     | 2007-000081                 | R-CHIP;2.7Kohm,5%,1/16W,DA,TP,1608       | .....    | SC24     | 2203-002494                 | C-CERAMIC,CHIP;470nF,10%,16V,X7R,TP,2012       |
| .....    | FR73     | 2007-000082                 | R-CHIP;3.3Kohm,5%,1/16W,DA,TP,1608       | .....    | SC25     | 2203-002494                 | C-CERAMIC,CHIP;470nF,10%,16V,X7R,TP,2012       |
| .....    | FR74     | 2007-000074                 | R-CHIP;100ohm,5%,1/16W,DA,TP,1608        | .....    | SC26     | 2203-002494                 | C-CERAMIC,CHIP;470nF,10%,16V,X7R,TP,2012       |
| .....    | FR75     | 2007-000074                 | R-CHIP;100ohm,5%,1/16W,DA,TP,1608        | .....    | SC31     | 2402-000179                 | C-AL,SMD;47uF,20%,16V,GP,TP,6.6x6.6x5.4        |
| .....    | FR76     | 2007-000070                 | R-CHIP;0ohm,5%,1/16W,DA,TP,1608          | .....    | SC32     | 2203-001656                 | C-CERAMIC,CHIP;0.47nF,5%,50V,NPO,TP,1608       |
| .....    | FR77     | 2007-000941                 | R-CHIP;47KOHM,5%,1/10W,DA,TP,2012        | .....    | SC33     | 2203-000257                 | C-CERAMIC,CHIP;10nF,10%,50V,X7R,TP,1608        |
| .....    | FR78     | 2007-000297                 | R-CHIP;10KOHM,1%,1/10W,DA,TP,2012        | .....    | SC34     | 2402-000179                 | C-AL,SMD;47uF,20%,16V,GP,TP,6.6x6.6x5.4        |
| .....    | FR79     | 2007-000297                 | R-CHIP;10KOHM,1%,1/10W,DA,TP,2012        | .....    | SC35     | 2203-000257                 | C-CERAMIC,CHIP;10nF,10%,50V,X7R,TP,1608        |
| .....    | FR80     | 2007-000297                 | R-CHIP;10KOHM,1%,1/10W,DA,TP,2012        | .....    | SC36     | 2402-000179                 | C-AL,SMD;47uF,20%,16V,GP,TP,6.6x6.6x5.4        |
| .....    | FR81     | 2007-000074                 | R-CHIP;100ohm,5%,1/16W,DA,TP,1608        | .....    | SC37     | 2203-000257                 | C-CERAMIC,CHIP;10nF,10%,50V,X7R,TP,1608        |
| .....    | FR82     | 2007-000074                 | R-CHIP;100ohm,5%,1/16W,DA,TP,1608        | .....    | SC38     | 2402-000179                 | C-AL,SMD;47uF,20%,16V,GP,TP,6.6x6.6x5.4        |
| .....    | FR96     | 2007-000070                 | R-CHIP;0ohm,5%,1/16W,DA,TP,1608          | .....    | SC39     | 2203-000257                 | C-CERAMIC,CHIP;10nF,10%,50V,X7R,TP,1608        |
| .....    | IC01A    | 1204-001938                 | IC-DECODER;VSP9407B-B11,MQFP,80P,14X14MM | .....    | SC40     | 2402-000179                 | C-AL,SMD;47uF,20%,16V,GP,TP,6.6x6.6x5.4        |
| .....    | IC02     | 1204-001814                 | IC-SELECTOR;CXA2151Q,QFP,48P,144MIL,PLAS | S.N.A    | SC41     | 2203-000257                 | C-CERAMIC,CHIP;10nF,10%,50V,X7R,TP,1608        |
| .....    | IC03     | 1001-001082                 | IC-VIDEO SWITCH;BA7657F,-SOP,24P,300MIL  | .....    | SC42     | 2402-000179                 | C-AL,SMD;47uF,20%,16V,GP,TP,6.6x6.6x5.4        |
| .....    | IC04     | 1204-001989                 | IC-VIDEO PROCESS;CXA2165Q,QFP,64P,20X14M | S.N.A    | SC43     | 2203-000257                 | C-CERAMIC,CHIP;10nF,10%,50V,X7R,TP,1608        |
| .....    | IC05     | 1203-002186                 | IC-POSIFIXED REG.;18,DPAK,3P,240MIL,PLA  | .....    | SC44     | 2402-000179                 | C-AL,SMD;47uF,20%,16V,GP,TP,6.6x6.6x5.4        |
| .....    | IC06     | 1203-001211                 | IC-VOL. DETECTOR;7027,SOT-89,3P,-PLASTI  | .....    | SC45     | 2203-000998                 | C-CERAMIC,CHIP;0.047nF,5%,50V,NPO,TP,160       |
| .....    | IC11     | 1203-002302                 | IC-POSIFIXED REG.;78RM33D,D-PAK,3P,-PL   | .....    | SC46     | 2203-000998                 | C-CERAMIC,CHIP;0.047nF,5%,50V,NPO,TP,160       |
| .....    | IC13     | 0801-000662                 | IC-CMOS LOGIC;74HC123,MULTIVIBATOR,SOP,1 | .....    | SC47     | 2402-000179                 | C-AL,SMD;47uF,20%,16V,GP,TP,6.6x6.6x5.4        |
| .....    | IC14     | 3301-001324                 | CORE-FERRITE BEAD;AB,150HM,2X1.25X0.9MM, | .....    | SC48     | 2203-000181                 | C-CERAMIC,CHIP;100nF,+80-20%,25V,Y5V,TP,       |
| .....    | IC15     | 3301-001324                 | CORE-FERRITE BEAD;AB,150HM,2X1.25X0.9MM, | .....    | SC49     | 2203-000998                 | C-CERAMIC,CHIP;0.047nF,5%,50V,NPO,TP,160       |
| .....    | PC01     | 2402-000179                 | C-AL,SMD;47uF,20%,16V,GP,TP,6.6x6.6x5.4  | .....    | SC50     | 2203-000998                 | C-CERAMIC,CHIP;0.047nF,5%,50V,NPO,TP,160       |
| .....    | PC02     | 2203-000181                 | C-CERAMIC,CHIP;100nF,+80-20%,25V,Y5V,TP, | .....    | SC51     | 2203-002494                 | C-CERAMIC,CHIP;470nF,10%,16V,X7R,TP,2012       |
| .....    | PC03     | 2402-000179                 | C-AL,SMD;47uF,20%,16V,GP,TP,6.6x6.6x5.4  | .....    | SC52     | 2203-002494                 | C-CERAMIC,CHIP;470nF,10%,16V,X7R,TP,2012       |
| .....    | PC04     | 2203-000181                 | C-CERAMIC,CHIP;100nF,+80-20%,25V,Y5V,TP, | .....    | SC53     | 2203-002494                 | C-CERAMIC,CHIP;470nF,10%,16V,X7R,TP,2012       |
| .....    | PC05     | 2203-000181                 | C-CERAMIC,CHIP;100nF,+80-20%,25V,Y5V,TP, | .....    | SC56     | 2203-000495                 | C-CERAMIC,CHIP;2.2nF,10%,50V,X7R,TP,2012       |
| .....    | PC06     | 2402-000179                 | C-AL,SMD;47uF,20%,16V,GP,TP,6.6x6.6x5.4  | .....    | SC57     | 2203-000495                 | C-CERAMIC,CHIP;2.2nF,10%,50V,X7R,TP,2012       |
| .....    | PC07     | 2402-001070                 | C-AL,SMD;470uF,20%,16V,GP,TP,10x10.2,-   | .....    | SC58     | 2203-000181                 | C-CERAMIC,CHIP;100nF,+80-20%,25V,Y5V,TP,       |
| .....    | PC08     | 2402-001070                 | C-AL,SMD;470uF,20%,16V,GP,TP,10x10.2,-   | .....    | SL01     | 3301-001324                 | CORE-FERRITE BEAD;AB,150HM,2X1.25X0.9MM,       |
| .....    | PC09     | 2402-001049                 | C-AL,CHIP;10uF,20%,16V,GP,TP,3.3x3.3x5.4 | .....    | SL02     | 3301-001186                 | CORE-FERRITE BEAD;AB,600ohm,3.2x1.6x1.3m       |
| .....    | PC10     | 2402-001049                 | C-AL,CHIP;10uF,20%,16V,GP,TP,3.3x3.3x5.4 | .....    | SO01     | 0501-000280                 | TR-SMALL SIGNAL;KSA1182,PNP,150mW,SOT-23       |
| .....    | PC11     | 2203-000181                 | C-CERAMIC,CHIP;100nF,+80-20%,25V,Y5V,TP, | .....    | SR01     | 2007-000074                 | R-CHIP;100ohm,5%,1/16W,DA,TP,1608              |
| .....    | PC12     | 2402-001049                 | C-AL,CHIP;10uF,20%,16V,GP,TP,3.3x3.3x5.4 | .....    | SR02     | 2007-000074                 | R-CHIP;100ohm,5%,1/16W,DA,TP,1608              |
| .....    | PC13     | 2203-000181                 | C-CERAMIC,CHIP;100nF,+80-20%,25V,Y5V,TP, | .....    | SR03     | 2007-000074                 | R-CHIP;100ohm,5%,1/16W,DA,TP,1608              |
| .....    | PC14     | 2203-000181                 | C-CERAMIC,CHIP;100nF,+80-20%,25V,Y5V,TP, | .....    | SR04     | 2007-000074                 | R-CHIP;100ohm,5%,1/16W,DA,TP,1608              |
| .....    | PC15     | 2203-000181                 | C-CERAMIC,CHIP;100nF,+80-20%,25V,Y5V,TP, | .....    | SR05     | 2007-000074                 | R-CHIP;100ohm,5%,1/16W,DA,TP,1608              |
| .....    | PC16     | 2203-000181                 | C-CERAMIC,CHIP;100nF,+80-20%,25V,Y5V,TP, | .....    | SR06     | 2007-000074                 | R-CHIP;100ohm,5%,1/16W,DA,TP,1608              |
| .....    | PC17     | 2203-000257                 | C-CERAMIC,CHIP;10nF,10%,50V,X7R,TP,1608  | .....    | SR07     | 2007-000080                 | R-CHIP;2Kohm,5%,1/16W,DA,TP,1608               |

Electrical Parts List

| Loc. No. | Code No.    | Description ; Specification                          | Remark | Loc. No. | Code No.    | Description ; Specification                          | Remark |
|----------|-------------|--|--------|----------|-------------|--|--------|
| ....5    | SR08        | 2007-000052 R-CHIP;10Kohm,1%,1/16W,DA,TP,1608        |        | ....4    | RFZ101      | 2008-001086 R-FUSIBLE(S);3.3ohm,5%,2W,AG,TP,3.9x12mm |        |
| ....5    | SR09        | 2007-000070 R-CHIP;0ohm,5%,1/16W,DA,TP,1608          |        | ....4    | RZ101       | 2001-000241 R-CARBON;1.5KOHM,5%,1/8W,AA,TP,1.8X3.2MM |        |
| ....5    | SR10        | 2007-000074 R-CHIP;100ohm,5%,1/16W,DA,TP,1608        |        | ....4    | RZ102       | 2001-000221 R-CARBON;1.2KOHM,5%,1/8W,AA,TP,1.8X3.2MM |        |
| ....5    | SR11        | 2007-000074 R-CHIP;100ohm,5%,1/16W,DA,TP,1608        |        | ....4    | RZ103       | 2003-000713 R-METAL OXIDE(S);47ohm,5%,2W,AF,TP,4x12m |        |
| ....5    | SR21        | 2007-000077 R-CHIP;470ohm,5%,1/16W,DA,TP,1608        |        | ....4    | RZ104       | 2001-001100 R-CARBON(S);2.70HM,5%,1/2W,AA,TP,2.4X6.4 |        |
| ....5    | SR22        | 2007-000070 R-CHIP;0ohm,5%,1/16W,DA,TP,1608          |        | ....4    | RZ105       | 2001-001139 R-CARBON(S);39KOHM,5%,1/2W,AA,TP,2.4X6.4 |        |
| ....5    | SR23        | 2007-000309 R-CHIP;10ohm,5%,1/16W,DA,TP,1608         |        | ....4    | RZ106       | 2001-001139 R-CARBON(S);39KOHM,5%,1/2W,AA,TP,2.4X6.4 |        |
| ....5    | SR25        | 2007-000309 R-CHIP;10ohm,5%,1/16W,DA,TP,1608         |        | ....4    | RZ107       | 2001-000331 R-CARBON;12KOHM,5%,1/8W,AA,TP,1.8X3.2MM  |        |
| ....5    | SR26        | 2007-000309 R-CHIP;10ohm,5%,1/16W,DA,TP,1608         |        | ....4    | RZ108       | 2001-000241 R-CARBON;1.5KOHM,5%,1/8W,AA,TP,1.8X3.2MM |        |
| ....5    | SR31        | 2007-000074 R-CHIP;100ohm,5%,1/16W,DA,TP,1608        |        | ....4    | RZ109       | 2001-000221 R-CARBON;1.2KOHM,5%,1/8W,AA,TP,1.8X3.2MM |        |
| ....5    | SR32        | 2007-000074 R-CHIP;100ohm,5%,1/16W,DA,TP,1608        |        | ....4    | RZ110       | 2001-001100 R-CARBON(S);2.70HM,5%,1/2W,AA,TP,2.4X6.4 |        |
| ....5    | SR33        | 2007-000074 R-CHIP;100ohm,5%,1/16W,DA,TP,1608        |        | ....4    | RZ111       | 2003-000713 R-METAL OXIDE(S);47ohm,5%,2W,AF,TP,4x12m |        |
| ....5    | SR34        | 2007-000074 R-CHIP;100ohm,5%,1/16W,DA,TP,1608        |        | ....4    | RZ112       | 2003-002157 R-METAL OXIDE;220OHM,5%,2W,AG,TP,6X16MM  |        |
| ....5    | SR35        | 2007-000074 R-CHIP;100ohm,5%,1/16W,DA,TP,1608        |        | ....4    | RZ113       | 2003-002157 R-METAL OXIDE;220OHM,5%,2W,AG,TP,6X16MM  |        |
| ....5    | SR36        | 2007-001166 R-CHIP;750HM,5%,1/10W,DA,TP,2012         |        | ....4    | RZ114       | 2003-000532 R-METAL OXIDE(S);18ohm,5%,2W,AF,TP,4x12m |        |
| ....5    | SR37        | 2007-001166 R-CHIP;750HM,5%,1/10W,DA,TP,2012         |        | ....4    | RZ115       | 2001-000832 R-CARBON;510OHM,5%,1/8W,AA,TP,1.8X3.2MM  |        |
| ....5    | SR38        | 2007-001166 R-CHIP;750HM,5%,1/10W,DA,TP,2012         |        | ....4    | RZ116       | 2001-000331 R-CARBON;12KOHM,5%,1/8W,AA,TP,1.8X3.2MM  |        |
| ....5    | SR39        | 2007-001166 R-CHIP;750HM,5%,1/10W,DA,TP,2012         |        | ....4    | RZ117       | 2001-000258 R-CARBON;1.8KOHM,5%,1/8W,AA,TP,1.8X3.2MM |        |
| ....5    | SR40        | 2007-001166 R-CHIP;750HM,5%,1/10W,DA,TP,2012         |        | ....4    | RZ118       | 2001-000258 R-CARBON;1.8KOHM,5%,1/8W,AA,TP,1.8X3.2MM |        |
| ....5    | SR47        | 2007-000074 R-CHIP;100ohm,5%,1/16W,DA,TP,1608        |        | ....4    | RZ119       | 2001-000554 R-CARBON;270OHM,5%,1/8W,AA,TP,1.8X3.2MM  |        |
| ....5    | SR48        | 2007-000074 R-CHIP;100ohm,5%,1/16W,DA,TP,1608        |        | ....4    | RZ121       | 2001-000666 R-CARBON;330HM,5%,1/8W,AA,TP,1.8X3.2MM   |        |
| ....5    | SR49        | 2007-000074 R-CHIP;100ohm,5%,1/16W,DA,TP,1608        |        | ....4    | RZ122       | 2001-000019 R-CARBON(S);100HM,5%,1/2W,AA,TP,2.4X6.4M |        |
| ....5    | SR53        | 2007-000074 R-CHIP;100ohm,5%,1/16W,DA,TP,1608        |        | ....4    | RZ123       | 2003-002157 R-METAL OXIDE;220OHM,5%,2W,AG,TP,6X16MM  |        |
| ....5    | SR73        | 2007-000258 R-CHIP;1.6KOHM,5%,1/10W,DA,TP,2012       |        | ..2      | AA94-08270A | ASSY PCB MISC-DY JACK;COMMANDO                       | S.N.A  |
| ....5    | SR74        | 2007-000077 R-CHIP;470ohm,5%,1/16W,DA,TP,1608        |        | ..3      | GT01        | AA60-40012D PIN-GT,ASSY;4P,T1.6,6-12.5-14MM,NYLON66  | S.N.A  |
| ....5    | SR75        | 2007-000290 R-CHIP;100OHM,5%,1/10W,DA,TP,2012        |        | ..3      | GT05        | AA60-40012D PIN-GT,ASSY;4P,T1.6,6-12.5-14MM,NYLON66  | S.N.A  |
| ....5    | YR43        | 2007-000074 R-CHIP;100ohm,5%,1/16W,DA,TP,1608        |        | ..3      | GT09        | AA60-40012D PIN-GT,ASSY;4P,T1.6,6-12.5-14MM,NYLON66  | S.N.A  |
| ....5    | YR44        | 2007-000074 R-CHIP;100ohm,5%,1/16W,DA,TP,1608        |        | ..3      | GT13        | AA60-40012D PIN-GT,ASSY;4P,T1.6,6-12.5-14MM,NYLON66  | S.N.A  |
| ....5    | YR45        | 2007-000074 R-CHIP;100ohm,5%,1/16W,DA,TP,1608        |        | ..3      | AA61-01197A | HOLDER PCB,DY;COMANDO,ABS V0,BLK                     | S.N.A  |
| ....4    | 0202-000187 | SOLDER-WIRE FLUX;-RS60S,D1.2,63Sn/37Pb               | S.N.A  | ..3      | AA97-07230N | ASSY AUTO;COMMANDO                                   | S.N.A  |
| ....4    | 0202-001167 | SOLDER-CREAM;RX3603-2330HO,S45A,PASTE,SN             | S.N.A  | ....4    | PCB         | AA41-00632A PCB-DY CONNECTION;FR-1,1L,A,1.6T,245X24  | S.N.A  |
| ..3      | AA63-00608A | SHIELD CASE;HERCULES TOP,SPT,TO.5,W140.              | S.N.A  | ....4    | R301        | 2001-001107 R-CARBON(S);220ohm,5%,1/2W,AA,TP,2.4x6.4 |        |
| ..3      | AA63-00610A | SHIELD CASE;COMMANDO,SPT,TO.5,W141.5,H1              | S.N.A  | ....4    | R302        | 2001-001107 R-CARBON(S);220ohm,5%,1/2W,AA,TP,2.4x6.4 |        |
| ..2      | AA94-08268A | ASSY PCB MISC-VM;COMMANDO                            | S.N.A  | ....4    | R303        | 2001-001107 R-CARBON(S);220ohm,5%,1/2W,AA,TP,2.4x6.4 |        |
| ..3      | CNZ101      | AA39-20055C LEAD CONNECTOR-ASSY;6P,YBNH025-06,67096  |        | ..3      | 0202-000187 | SOLDER-WIRE FLUX;-RS60S,D1.2,63Sn/37Pb               | S.N.A  |
| ....4    | QZ101       | AA96-00243M ASSY H/S;-AMP,AA62-000450A,2SA1011,HERC  | S.N.A  | ..2      | AA94-08380A | ASSY PCB MISC-SENSOR;SVP-55W9HD,P54A                 | S.N.A  |
| ....4    | 0205-000129 | GREASE-SILICON;SC102,JAPAN                           | S.N.A  | ..3      | CN01        | 3711-000447 CONNECTOR-HEADER;3WALL,3P,1R,2.5mm,ANGLE |        |
| ....4    | 0502-000131 | TR-POWER;2SA1011-D,PNP,1.2W,TO-220,-.60              |        | ..3      | Q01         | 0603-001098 PHOTO TR;NPN,20V,5V,20MA,50MW,ST         |        |
| ....4    | 6003-000335 | SCREW-TAPTITE;RH,+,2S,M3,L8,ZPC(YEL),SWR             | S.N.A  | ..3      | 0202-000187 | SOLDER-WIRE FLUX;-RS60S,D1.2,63Sn/37Pb               | S.N.A  |
| ....4    | AA62-00045A | HEAT SINK-PS;-T1.0,-.DREAM,-.S.N.A                   | S.N.A  | ..3      | AA97-07428A | ASSY AUTO;0000                                       | S.N.A  |
| ..3      | QZ102       | AA96-00243L ASSY H/S;-CRT,AA62-000450A,2SC2344,HERC  | S.N.A  | ....4    | PCB         | AA41-00741A PCB-SENSOR;SVP-55W9HD,FR-4,2L,A,1.6T,245 | S.N.A  |
| ....4    | 0205-000129 | GREASE-SILICON;SC102,JAPAN                           | S.N.A  | ....4    | R01         | 2001-000522 R-CARBON;22KOHM,5%,1/8W,AA,TP,1.8X3.2MM  |        |
| ....4    | 0502-000153 | TR-POWER;2SC2344-D,NPN,1.2W,TO-220,-.60              |        |          |             |  |        |
| ....4    | 6003-000335 | SCREW-TAPTITE;RH,+,2S,M3,L8,ZPC(YEL),SWR             | S.N.A  |          |             |  |        |
| ....4    | AA62-00045A | HEAT SINK-PS;-T1.0,-.DREAM,-.S.N.A                   | S.N.A  |          |             |  |        |
| ..3      | RZ120       | 2008-001097 R-FUSIBLE(S);330HM,5%,1/2W,AC,BK,2.5X6.5 |        |          |             |  |        |
| ..3      | AA33-00017A | MAGNET CONVERGENCE;JH 92LT - 29G,-.29.1M             |        |          |             |  |        |
| ..3      | 3301-001201 | CORE-FERRITE;AE,21x11x32mm,1500,280G                 |        | 1        | *           | BP91-00259A ASSY PRT;HCM4215WX/XAA,P55A,ASSY-PRT     | S.N.A  |
| ..3      | 0202-000187 | SOLDER-WIRE FLUX;-RS60S,D1.2,63Sn/37Pb               | S.N.A  | ..2      | BP91-00256A | ASSY CPT-R;HCM4215WX/XAA,P55A,DELTA71,RE             |        |
| ..3      | AA97-07230M | ASSY AUTO;COMMANDO                                   | S.N.A  | ..3      | BC+AL       | AA60-10011A SCREW-TAPTITE;-SWRCH18A,M4,L12,HH,+,PC   | S.N.A  |
| ....4    | CNZ102      | 3711-002642 CONNECTOR-HEADER;BOX,3P,1R,2.5mm,STRAIGH |        | ..3      | AA67-00094A | LENS;-SSM-65,RED,-.C ELEMENT                         |        |
| ....4    | CNZ103      | 3711-002642 CONNECTOR-HEADER;BOX,3P,1R,2.5mm,STRAIGH |        | ..3      | AA67-00092A | LENS-ASSY;-SSM-65,CLEAR A/B,-.S.N.A                  |        |
| ....4    | CNZ104      | 3711-002642 CONNECTOR-HEADER;BOX,3P,1R,2.5mm,STRAIGH |        | ..3      | AA63-00076A | SPACER-LENS;PROJECTION,FELT,-.BROWN                  | S.N.A  |
| ....4    | CZ101       | 2401-002144 C-AL;47uF,20%,16V,GP,TP,5x11,5           |        | ..3      | AA61-00810B | HOLDER-CAP;PROJ,PC,CLR                               | S.N.A  |
| ....4    | CZ102       | 2401-001157 C-AL;33uF,20%,160V,GP,TP,12.5x20,5       |        | ..3      | AA61-00806B | CASE-COUPLER,R;PROJ,ALDC,T8,BLK                      | S.N.A  |
| ....4    | CZ103       | 2201-000516 C-CERAMIC,DISC;4.7nF,+100-0%,500V,Y5U,TP |        | ..3      | AA33-00016A | MAGNET CONVERGENCE;JH 92LT - 29F,-.29.1M             |        |
| ....4    | CZ104       | 2201-000193 C-CERAMIC,DISC;0.01nF,0.25pF,50V,NPO,TP  |        | ..3      | AA27-00249A | DEFLECTION YOKE;-DPD-5292AA,S/S,7,29.1               |        |
| ....4    | CZ105       | 2201-000516 C-CERAMIC,DISC;4.7nF,+100-0%,500V,Y5U,TP |        | ..3      | BP61-00009A | HOLDER-CRT;42W5,PC/ABS,BLK,GF20%                     | S.N.A  |
| ....4    | CZ106       | 2201-000193 C-CERAMIC,DISC;0.01nF,0.25pF,50V,NPO,TP  |        | ..3      | AA91-00722A | ASSY-BRKT,CRT,SECC T1.6,PROJ                         |        |
| ....4    | CZ107       | 2401-001513 C-AL;47uF,20%,16V,WT,TP,5x11,5           |        | ..4      | AA61-00473B | BRACKET-CRT;53,SECC,T1.6,-.S.N.A                     |        |
| ....4    | CZ108       | 2401-001220 C-AL;4.7uF,20%,160V,GP,TP,8x11,5,5       |        | ..4      | AA61-00615B | BRACKET-EARTH;54J8,PBS,TO.5,-.S.N.A                  |        |
| ....4    | CZ109       | 2401-001220 C-AL;4.7uF,20%,160V,GP,TP,8x11,5,5       |        | ..4      | AA61-00812A | SPRING-WIRE;PROJ,STS,3.6                             | S.N.A  |
| ....4    | CZ110       | 2201-000604 C-CERAMIC,DISC;0.056nF,+100-0%,500V,SL,T |        | ..3      | AA67-00185A | LENS-PLATE;-SSM-65,SHADING PLATE                     |        |
| ....4    | CZ111       | 2401-000480 C-AL;10uF,20%,50V,GP,TP,5x11,5           |        | ..3      | AA61-00056B | BRACKET-LENS;PROJECTION,SECC,T1.6,-.S.N.A            |        |
| ....4    | CZ112       | 2401-000832 C-AL;220uF,20%,25V,GP,TP,8x11,5,5        |        | ..3      | AA39-00018A | LEAD CONNECTOR-ASSY;UL1015#22,UL/CSA,1P              |        |
| ....4    | DZ101       | 0402-000546 DIODE-RECTIFIER;TVR10G,400V,1.0A,DO-41,T |        | ..3      | AA26-30006F | TRANS-FLYBACK;-FWZ-50A001C,55,30KV                   |        |
| ....4    | DZ102       | 0401-000005 DIODE-SWITCHING;1N4148,100V,200mA,DO-35, |        | ..3      | AA03-00200A | CDT MONO;P16LSG03RJA,FREE,3.30mH,2.20mH,             |        |
| ....4    | DZ103       | 0402-000546 DIODE-RECTIFIER;TVR10G,400V,1.0A,DO-41,T |        | ..3      | AA60-00127B | SPACER-LENS;PROJ,SILICONE,D/GRAY                     | S.N.A  |
| ....4    | DZ104       | 0402-000546 DIODE-RECTIFIER;TVR10G,400V,1.0A,DO-41,T |        | ..3      | AA60-00126B | SPACER-CAP;PROJ,EPDM,BLK                             | S.N.A  |
| ....4    | DZ105       | 0401-000005 DIODE-SWITCHING;1N4148,100V,200mA,DO-35, |        | ..3      | AA60-00125B | SPACER-CRT;PROJ,SILICONE,D/GRAY                      | S.N.A  |
| ....4    | DZ106       | 0401-000005 DIODE-SWITCHING;1N4148,100V,200mA,DO-35, |        | ..3      | AA60-00074A | SPACER-DY;PJT,SILICON RUBBER,-.GRAY,                 | S.N.A  |
| ....4    | LZ101       | 2701-000002 INDUCTOR-AXIAL;100uH,10%,4.2x9.8mm       |        | ..2      | BP91-00257A | ASSY CPT-G;HCM4215WX/XAA,P55A,DELTA71,GR             |        |
| ....4    | PCB         | AA41-00611A PCB-VM;FR-1,1L,A,1.6T,245X245,6A,113X62  | S.N.A  | ..3      | BC+AL       | AA60-10011A SCREW-TAPTITE;-SWRCH18A,M4,L12,HH,+,PC   | S.N.A  |
| ....4    | QZ103       | 0501-000283 TR-SMALL SIGNAL;KSA539,PNP,400mW,TO-92,T |        | ..3      | AA63-00076A | SPACER-LENS;PROJECTION,FELT,-.BROWN                  | S.N.A  |
| ....4    | QZ104       | 0501-000389 TR-SMALL SIGNAL;KSC815,NPN,400mW,TO-92,T |        | ..3      | AA61-00810B | HOLDER-CAP;PROJ,PC,CLR                               | S.N.A  |
| ....4    | QZ105       | 0501-000389 TR-SMALL SIGNAL;KSC815,NPN,400mW,TO-92,T |        | ..3      | AA61-00809B | HOLDER-CRT;PROJ,PC/ABS GF 20%,BLK                    | S.N.A  |
| ....4    | QZ106       | 0501-000389 TR-SMALL SIGNAL;KSC815,NPN,400mW,TO-92,T |        | ..3      |             |  |        |

ASSY PRT



| Loc. No. | Code No.    | Description ; Specification              | Remark |
|----------|-------------|--|--------|
| ...      | AA61-00807B | CASE-COUPLER,G,PROJ,ALDC,T8,BLK          | S.N.A  |
| ...      | AA61-00056B | BRACKET-LENS;PROJECTION,SECC,T1.6,-,-,-  | S.N.A  |
| ...      | AA27-00249A | DEFLECTION YOKE;-DPD-5292AA,S/S,7.29.1   |        |
| ...      | AA91-00722A | ASSY-BRKT,CRT,SECC T1.6,PROJ             |        |
| ...      | AA61-00473B | BRACKET-CRT;53,SECC,T1.6,-,-,-           | S.N.A  |
| ...      | AA61-00615B | BRACKET-EARTH;54J8,PBS,TO.5,-,-,-        | S.N.A  |
| ...      | AA61-00812A | SPRING-WIRE;PROJ,STS,3.6                 | S.N.A  |
| ...      | AA67-00185A | LENS-PLATE;-SSM-65,SHADING PLATE         |        |
| ...      | AA67-00095A | LENS;-SSM-65,GREEN,-,-,-,C ELEMENT       |        |
| ...      | AA67-00092A | LENS-ASSY;-SSM-65,CLEAR A/B,-,-,-        |        |
| ...      | AA39-00018A | LEAD CONNECTOR-ASSY;UL1015#22,UL/CSA,1P  |        |
| ...      | AA26-30006F | TRANS-FLYBACK;-FWZ-50A001C,55,30KV       |        |
| ...      | AA03-00201A | CDT MONO;P16LSG03HKA,FREE,3.30mH,2.20mH, |        |
| ...      | AA60-00127B | SPACER-LENS;PROJ,SILICONE,D/GRAY         | S.N.A  |
| ...      | AA60-00126B | SPACER-CAP;PROJ,EPDM,BLK                 | S.N.A  |
| ...      | AA60-00125B | SPACER-CRT;PROJ,SILICONE,D/GRAY          | S.N.A  |
| ...      | AA60-00074A | SPACER-DY;PJT,SILICON RUBBER,-,-,-,GRAY, | S.N.A  |
| ...      | BP91-00258A | ASSY CPT-B;HCM4215WX/XAA,P55A,DELTA71,BU |        |
| ...      | AA60-10011A | SCREW-TAPTITE;-SWRCH18A,M4,L12,HH,+PC,   | S.N.A  |
| ...      | AA67-00093A | LENS;-SSM-65,CLEAR,-,-,-,C ELEMENT       |        |
| ...      | AA67-00092A | LENS-ASSY;-SSM-65,CLEAR A/B,-,-,-        |        |
| ...      | AA63-00076A | SPACER-LENS;PROJECTION,FELT,-,-,-,BROWN  | S.N.A  |
| ...      | AA61-00810B | HOLDER-CAP;PROJ,PC,CLR                   | S.N.A  |
| ...      | AA61-00808B | CASE-COUPLER,B;PROJ,ALDC,T8,BLK          | S.N.A  |
| ...      | AA33-00018A | MAGNET CONVERGENCE;JH 9ZLT - 36F,-,29.1M |        |
| ...      | AA27-00249A | DEFLECTION YOKE;-DPD-5292AA,S/S,7.29.1   |        |
| ...      | BP61-00009A | HOLDER-CRT;42W5,PC/ABS,BLK,GF20%         | S.N.A  |
| ...      | AA91-00722A | ASSY-BRKT,CRT,SECC T1.6,PROJ             |        |
| ...      | AA61-00473B | BRACKET-CRT;53,SECC,T1.6,-,-,-           | S.N.A  |
| ...      | AA61-00615B | BRACKET-EARTH;54J8,PBS,TO.5,-,-,-        | S.N.A  |
| ...      | AA61-00812A | SPRING-WIRE;PROJ,STS,3.6                 | S.N.A  |
| ...      | AA67-00185A | LENS-PLATE;-SSM-65,SHADING PLATE         |        |
| ...      | AA61-00056B | BRACKET-LENS;PROJECTION,SECC,T1.6,-,-,-  | S.N.A  |
| ...      | AA39-00018A | LEAD CONNECTOR-ASSY;UL1015#22,UL/CSA,1P  |        |
| ...      | AA26-30006F | TRANS-FLYBACK;-FWZ-50A001C,55,30KV       |        |
| ...      | AA03-00201A | CDT MONO;P16LSG03BMB,FREE,3.30mH,2.20mH, |        |
| ...      | AA60-00128B | SPACER-CRT;PROJ(65),SILICONE,D/GRAY      | S.N.A  |
| ...      | AA60-00127B | SPACER-LENS;PROJ,SILICONE,D/GRAY         | S.N.A  |
| ...      | AA60-00126B | SPACER-CAP;PROJ,EPDM,BLK                 | S.N.A  |
| ...      | AA60-00074A | SPACER-DY;PJT,SILICON RUBBER,-,-,-,GRAY, | S.N.A  |

### ASSY COVER FRONT

| Loc. No. | Code No. | Description ; Specification | Remark                                   |
|----------|----------|-----------------------------|--|
| 1        | *        | BP90-00007P                 | ASSY COVER FRONT;42W5,HCM4216WX/XAA      |
| ...      | AC+BCM   | 6003-001339                 | SCREW-TAPTITE;HH,+B,M4,L15,ZPC(BLK),SWR  |
| ...      | BCM+CW   | 6006-001094                 | SCREW-ASS'Y WOOD;WWW,HH,+M7,L32,ZPC(YEL) |
| ...      | BF+BCM   | AA60-10011A                 | SCREW-TAPTITE;-SWRCH18A,M4,L12,HH,+PC,   |
| ...      | BS+CF    | AA60-10011A                 | SCREW-TAPTITE;-SWRCH18A,M4,L12,HH,+PC,   |
| ...      | CF+CW    | 6005-001003                 | SCREW-WOOD;HH,+M4,L19,ZPC(BLK),SWRCH18A  |
| ...      | CGH+BC   | AA60-10011A                 | SCREW-TAPTITE;-SWRCH18A,M4,L12,HH,+PC,   |
| ...      | CP+KC    | 6003-001023                 | SCREW-TAPTITE;RWH,+B,M3,L10,ZPC(YEL),SW  |
| ...      | CPC+CW   | 6005-001003                 | SCREW-WOOD;HH,+M4,L19,ZPC(BLK),SWRCH18A  |
| ...      | HP+BCM   | AA60-10011A                 | SCREW-TAPTITE;-SWRCH18A,M4,L12,HH,+PC,   |
| ...      | HV+BCM   | AA60-10011A                 | SCREW-TAPTITE;-SWRCH18A,M4,L12,HH,+PC,   |
| ...      | IS+CW    | 6005-001003                 | SCREW-WOOD;HH,+M4,L19,ZPC(BLK),SWRCH18A  |
| ...      |          | BP61-00023B                 | BRACKET-SCREEN,ASSY(TOP);42W5,SECC,T1.0, |
| ...      |          | AA61-01121A                 | BRACKET-SCREEN,TB;42W5,SECC,T1.0         |
| ...      |          | BP61-00052A                 | HOLDER-WIRE;PJT,NYLON,66,NATURAL         |
| ...      |          | BP61-00043A                 | HOLDER-SENSOR;W9,ABS ,HB,BLK             |
| ...      |          | BP61-00024B                 | BRACKET-SCREEN,ASSY(BOT);42W5,SECC,T1.0, |
| ...      |          | AA61-01121A                 | BRACKET-SCREEN,TB;42W5,SECC,T1.0         |
| ...      |          | AA65-00020A                 | CLAMP CORE-WIRE;55W9,NYLON 66            |
| ...      |          | BP61-00043A                 | HOLDER-SENSOR;W9,ABS ,HB,BLK             |
| ...      |          | BP61-00052A                 | HOLDER-WIRE;PJT,NYLON,66,NATURAL         |
| ...      |          | BP61-00025B                 | BRACKET-SCREEN,ASSY(R);42W5,SECC,T1.0,NE |
| ...      |          | AA61-01121A                 | BRACKET-SCREEN,TB;42W5,SECC,T1.0         |
| ...      |          | BP61-00043A                 | HOLDER-SENSOR;W9,ABS ,HB,BLK             |
| ...      |          | BP61-00052A                 | HOLDER-WIRE;PJT,NYLON,66,NATURAL         |
| ...      |          | BP61-00026B                 | BRACKET-SCREEN,ASSY(L);42W5,SECC,T1.0,NE |
| ...      |          | AA61-01121A                 | BRACKET-SCREEN,TB;42W5,SECC,T1.0         |
| ...      |          | BP61-00043A                 | HOLDER-SENSOR;W9,ABS ,HB,BLK             |
| ...      |          | BP61-00052A                 | HOLDER-WIRE;PJT,NYLON,66,NATURAL         |
| ...      |          | BP64-00029A                 | INLAY-SUPPORT;42W5,PS SHEET,TO.5,94V0    |
| ...      |          | BP91-00005D                 | ASSY-CABINET,WOOD;;WOOD,MIJU,42W5        |

| Loc. No. | Code No. | Description ; Specification | Remark                                   |
|----------|----------|-----------------------------|--|
| ...      | SPK+CW   | AA60-10051A                 | SCREW-WOOD;-SWRCH18A,M4,L16,PH,+,-,-,ZP  |
| ...      |          | AA61-00058D                 | HOLDER-JERSEY;W3,ABS V0,GRAY,G4309       |
| ...      |          | AA61-00533B                 | BRACKET-GRILLE;43,54,62J8,SECC-1 ,TO.5,- |
| ...      |          | AA64-02724A                 | CABINET-WOOD;42W5,WOOD,SDE8336R          |
| ...      |          | AA98-00049A                 | ASSY-LEAD,CON;-LEAD-CON,CORE,AA39-20505  |
| ...      |          | 3301-001201                 | CORE-FERRITE;AE,21x11x32mm,1500,280G     |
| ...      |          | BP61-00019A                 | HOLDER-PALLET;42W5,HIPS HB,BLK           |
| ...      |          | BP61-00035A                 | BRACKET-GRILLE;42W5,SECC-1,T1.0          |
| ...      |          | AA61-00506B                 | HOLDER-CRT,MAIN;43,54,62J8,HIPS,-,-,-,BL |
| ...      |          | 3001-000279                 | SPEAKER;30W,8ohm,91dB,20Hz               |
| ...      |          | 3001-001107                 | SPEAKER;20W,8ohm,95dB,1300Hz             |
| ...      |          | AA39-00086A                 | LEAD CONNECTOR-ASSY;;2.2UF,REC,REC,200MM |
| ...      |          | AA61-00094G                 | HOLDER-RAIL;42W5,ABS HB,L480,BLK,2HOLE   |
| ...      |          | AA61-00097A                 | HOLDER-WIRE;-NYLON 6/6,-,-,-,NTR,-       |
| ...      |          | BP91-00008D                 | ASSY-PANNEL,CONTROL;;HIPS HB,G4309,SVM11 |
| ...      | KC+CPC   | 6003-001026                 | SCREW-TAPTITE;RH,+B,M4,L15,ZPC(BLK),SWR  |
| ...      | VC+CPC   | 6003-001019                 | SCREW-TAPTITE;RH,+B,M4,L12,ZPC(BLK),SWR  |
| ...      | Z        | 6003-001019                 | SCREW-TAPTITE;RH,+B,M4,L12,ZPC(BLK),SWR  |
| ...      |          | AA64-02726A                 | CABINET-PANEL,CONTROL;42W5,HIPS,HB,G4309 |
| ...      |          | AA64-02739A                 | KNOB-CONTROL;42W5,ABS,HB,G3676,COT       |
| ...      |          | AA64-02740A                 | KNOB-POWER;42W5,ABS,HB,G3676,COT         |
| ...      |          | AA64-02742A                 | WINDOW-RMC,LED;42W5,PC,CLR               |
| ...      |          | BP64-00035D                 | INLAY-DECORATION;42W5,AL,TO.4,MIJU       |
| ...      |          | AA61-01130A                 | GUIDE-KNOB,CONTROL;42W5,ABS HB,G3676,SVM |
| ...      |          | AA61-01132A                 | VELCRO-A;COMMANDO,BST1 1/4H              |
| ...      |          | AA61-01133A                 | VELCRO-B;COMMANDO,BST1 1/4H              |
| ...      |          | AA61-20129A                 | HOLDER-WIRE;-NYLON-66,-,-,-,NTR,DAFC-25  |
| ...      |          | AA61-60003J                 | SPRING-CS;-SUS304,-,-,OD6,N7,OD6,-,-,-   |
| ...      |          | BP91-00007F                 | ASSY-FRONT,BOT;;HIPS HB,G4309,SVM1132+SV |
| ...      | VC+CFB   | 6003-001019                 | SCREW-TAPTITE;RH,+B,M4,L12,ZPC(BLK),SWR  |
| ...      |          | BP73-00001A                 | RUBBER-SHEET;42W5,NBB RUBBER,GRAY,10*20  |
| ...      |          | AA64-02743A                 | BADGE-DECORATION;42W5,AL,NI,RS           |
| ...      |          | AA64-02725F                 | CABINET-FRONT,BOT;42W5,HIPS,VO,G4309,SVM |
| ...      |          | AA61-01132A                 | VELCRO-A;COMMANDO,BST1 1/4H              |
| ...      |          | BP91-00006E                 | ASSY-FRONT,MASK;;HIPS HB,G4309,SVM1132,M |
| ...      |          | AA64-02727E                 | CABINET-FRONT,MASK TOP;42W5,HIPS,HB,G430 |
| ...      |          | AA64-02211E                 | BADGE-BRAND                              |
| ...      |          |                             | ;72MM,AL FORGING,SVM1132,SAMS            |
| ...      |          | AA61-01133A                 | VELCRO-B;COMMANDO,BST1 1/4H              |
| ...      |          | 6003-001019                 | SCREW-TAPTITE;RH,+B,M4,L12,ZPC(BLK),SWR  |
| ...      |          | BP39-00009A                 | LEAD CONNECTOR ASSY;P54A/SVP-42W5,UL2547 |
| ...      |          | AA26-00101A                 | TRANS FBT;FWZ50A001E/FFA97513B,12KV,5P-  |
| ...      |          | AA60-00072B                 | SPACER-COVER,DUST;43,54,62J9,SPONGE 94HF |
| ...      |          | AA61-00475B                 | BRACKET-CRT,MAIN;54,SECC,T1.6,-,-,-      |
| ...      |          | AA67-00193A                 | SCREEN-TINT;42W,958*550,T=0.73,P=052     |
| ...      |          | AA67-00193B                 | SCREEN-FRESNEL;42W,960*552,T=2.0         |
| ...      |          | AA67-00207A                 | SCREEN-FILTER;T=82%,960*552*2,G=110,AG   |
| ...      |          | AA73-00005B                 | RUBBER-CAP;FLAT,PRJ,SILICONE RUBBER,WHIT |

### ASSY COVER REAR

| Loc. No. | Code No. | Description ; Specification | Remark                                    |
|----------|----------|-----------------------------|---|
| 1        | *        | BP90-00008D                 | ASSY COVER REAR;42W5,HCM4215WX/XAA        |
| ...      | BM+CBT   | 6003-001026                 | SCREW-TAPTITE;RH,+B,M4,L15,ZPC(BLK),SWR   |
| ...      | CBB+CB   | 6003-001026                 | SCREW-TAPTITE;RH,+B,M4,L15,ZPC(BLK),SWR   |
| ...      | CBT+CF   | 6003-001026                 | SCREW-TAPTITE;RH,+B,M4,L15,ZPC(BLK),SWR   |
| ...      | CBT+CP   | 6003-001026                 | SCREW-TAPTITE;RH,+B,M4,L15,ZPC(BLK),SWR   |
| ...      | CBT+CW   | 6005-001003                 | SCREW-WOOD;HH,+M4,L19,ZPC(BLK),SWRCH18A   |
| ...      | HC+CW    | 6005-001003                 | SCREW-WOOD;HH,+M4,L19,ZPC(BLK),SWRCH18A   |
| ...      | TB+RJK   | 6003-001026                 | SCREW-TAPTITE;RH,+B,M4,L15,ZPC(BLK),SWR   |
| ...      | TB+TU    | 6003-001026                 | SCREW-TAPTITE;RH,+B,M4,L15,ZPC(BLK),SWR   |
| ...      |          | AA65-30008A                 | CLAMP-CORD;-PE,HB,-,BLK,-                 |
| ...      |          | BP61-00008A                 | BRACKET-MIRROR,ASSY;42W5,SECC,T1.0,01123  |
| ...      |          | AA61-01123A                 | BRACKET-MIRROR;42W5,SECC,T1.0             |
| ...      |          | BP60-00005A                 | SPACER-SPONGE;42W5,RUBBER-SPONGE,T3       |
| ...      |          | BP96-00038A                 | ASSY COVER P-TERMINAL,ANT;42W5,HIPS VO,B  |
| ...      |          | AA64-02836B                 | INLAY-TERMINAL,NT;42W5,PS SHEET,TO.5,BLK  |
| ...      |          | AA65-00023A                 | TERMINAL-BOARD,ANT;;HIPS VO,BLK           |
| ...      |          | AA67-00204A                 | MIRROR-FRONT;42W5,FSM,870*633*446         |
| ...      |          | AA64-60449B                 | INLAY-COVER;SP-434,UMF,PS,TO.5,149.3X69.5 |
| ...      |          | AA64-60421C                 | INLAY-COVER;-PS,TO.3,-,-,BLK,SEA          |
| ...      |          | AA64-02729B                 | CABINET-BACK,BOT;42W5,HIPS,VO,G4309       |
| ...      |          | AA64-02728A                 | CABINET-BACK,TOP;42W5,HIPS,HB,G4309       |

Electrical Parts List

| Loc. No.               | Code No. | Description ; Specification                       | Remark | Loc. No.              | Code No. | Description ; Specification                          | Remark |
|------------------------|----------|---|--------|-----------------------|----------|--|--------|
| <b>ASSY P/MATERIAL</b> |          |   |        | <b>ASSY ACCESSORY</b> |          |  |        |
| 1                      | *        | BP92-00009A ASSY P/MATERIAL;42W5,SVP-42W5HR       | S.N.A  | 1                     | *        | BP92-00012A ASSY ACCESSORY;HCM4215WX/MVT,P55A        | S.N.A  |
| ..2                    |          | AA61-20285A HOLDER-BOX;3456,PP,-,-,WHT,VO         | S.N.A  | ..2                   |          | BP68-00021A MANUAL USERS;HCM4215W,ENG,W/P100G,P55A,B |        |
| ..2                    |          | AA60-40006A PIN-STAPLE;-,-,H18,33X17.8X2.4,-,AUTO | S.N.A  | ..2                   |          | AA59-00262A REMOCON;TM63,COMMONDO,48,G6671B,EX,S/S   |        |
|                        |          |   |        | ..2                   |          | AA39-00006A CABLE-RCA;,3000MM                        |        |
| <b>ASSY BOX</b>        |          |   |        |                       |          |  |        |
| 1                      | *        | BP92-00008N ASSY BOX;42W5,HCM4216WX/XAA           |        |                       |          |  |        |
| <b>ASSY LABEL</b>      |          |   |        |                       |          |  |        |
| 1                      | *        | BP92-00077A ASSY LABEL;HCM4216WX/XAA,P55A         |        |                       |          |  |        |

## 7-3 HCM422WX/XAA

| Loc. No.            | Code No. | Description ; Specification                           | Remark | Loc. No. | Code No. | Description ; Specification                          | Remark |
|---------------------|----------|---|--------|----------|----------|--|--------|
| <b>ASSY CHASSIS</b> |          |   |        |          |          |  |        |
| 1                   | *        | BP91-00252A ASSY CHASSIS;HCM422WX/XAA,P55A            |        | ....     | C540     | 2401-000430 C-AL;10uF,20%,250V,GP,TP,10x16mm,5m      |        |
| ..2                 | PM+HC    | 6003-001023 SCREW-TAPTITE;RWH,+,B,M3,L10,ZPC(YEL),SW  | S.N.A  | ....     | C541     | 2201-000723 C-CERAMIC,DISC;4.7nF,20%,3KV,Y5U,TP,16x5 |        |
| ..2                 | PP+HC    | 6003-001023 SCREW-TAPTITE;RWH,+,B,M3,L10,ZPC(YEL),SW  | S.N.A  | ....     | C543     | 2201-000983 C-CERAMIC,DISC;1nF,10%,2kV,Y5P,TP,9x5,7  |        |
| ..2                 | SMW-GN   | AA39-20010D LEAD CONNECTOR-ASSY;,1P,YFH800-01,S,400,  |        | ....     | C544     | 2201-000599 C-CERAMIC,DISC;0.56nF,10%,500V,Y5P,TP,5  |        |
| ..2                 |          | AA94-08582A ASSY PCB MISC-CRT;COMMANDO,C2             |        | ....     | C562     | 2401-000027 C-AL;4.7uF,20%,50V,GP,TP,5x11,5          |        |
| ...3                | CN501    | 3711-002648 CONNECTOR-HEADER;BOX,9P,1R,2.5mm,STRAIGH  |        | ....     | C563     | 2201-000119 C-CERAMIC,DISC;100nF,+80-20%,50V,Y5V,TP, |        |
| ...3                | CN502    | 3711-003052 CONNECTOR-HEADER;BOX,10P,1R,2.5MM,STRAIG  |        | ....     | C564     | 2401-001571 C-AL;47uF,+20%-0%,50V,GP,TP,8x11.5       |        |
| ...3                | CN502B   | 3711-003052 CONNECTOR-HEADER;BOX,10P,1R,2.5MM,STRAIG  |        | ....     | C565     | 2305-000149 C-FILM,MPEF;100nF,5%,100V,TP,12x12.5x6.5 |        |
| ...3                | CN503    | 3711-003973 CONNECTOR-HEADER;BOX,11P,1R,2.5mm,STRAIG  |        | ....     | C566     | 2401-000430 C-AL;10uF,20%,250V,GP,TP,10x16mm,5m      |        |
| ...3                | CN503R   | 3711-003973 CONNECTOR-HEADER;BOX,11P,1R,2.5mm,STRAIG  |        | ....     | C567     | 2305-000154 C-FILM,MPEF;100nF,5%,400V,TP,21.5x6.5x11 |        |
| ...3                | CN504    | 3711-002645 CONNECTOR-HEADER;BOX,6P,1R,2.5mm,STRAIGH  |        | ....     | C570     | 2401-000430 C-AL;10uF,20%,250V,GP,TP,10x16mm,5m      |        |
| ...3                | CNW401   | AA39-20027B LEAD CONNECTOR-ASSY;,6P,67096-006,S,400,  |        | ....     | C571     | 2201-000723 C-CERAMIC,DISC;4.7nF,20%,3KV,Y5U,TP,16x5 |        |
| ...3                | CNW501   | AA39-20031D LEAD CONNECTOR-ASSY;,9P,67096-009,S,500,  |        | ....     | C573     | 2201-000983 C-CERAMIC,DISC;1nF,10%,2kV,Y5P,TP,9x5,7  |        |
| ...3                | CNW502   | AA39-00112A LEAD CONNECTOR-ASSY;,10P;35155-1000,S,30  |        | ....     | C574     | 2201-000599 C-CERAMIC,DISC;0.56nF,10%,500V,Y5P,TP,5  |        |
| ...3                | CNW503   | AA39-00120F LEAD CONNECTOR ASSY;SIR-T165,UL1007#26,U  |        | ....     | D361     | 0401-000005 DIODE-SWITCHING;1N4148,100V,200mA,DO-35, |        |
| ...3                | GBW-GN   | AA39-20010D LEAD CONNECTOR-ASSY;,1P,YFH800-01,S,400,  |        | ....     | D362     | 0401-000005 DIODE-SWITCHING;1N4148,100V,200mA,DO-35, |        |
| ...3                | GBW-SC   | BP39-00004C LEAD CONNECTOR ASSY;P55A/HCM4215W,UL3239  |        | ....     | D371     | 0401-000005 DIODE-SWITCHING;1N4148,100V,200mA,DO-35, |        |
| ...3                | GRW-GN   | AA39-20010D LEAD CONNECTOR-ASSY;,1P,YFH800-01,S,400,  |        | ....     | D372     | 0401-000005 DIODE-SWITCHING;1N4148,100V,200mA,DO-35, |        |
| ...3                | GRW-SC   | BP39-00004C LEAD CONNECTOR ASSY;P55A/HCM4215W,UL3239  |        | ....     | D373     | 0402-000243 DIODE-RECTIFIER;RC2-V1,2000V,0.2A,DO-201 |        |
| ...3                | IC501    | AA96-50311L ASSY H/S;-AMP,AA62-30175D ,TDA6111Q.HE    | S.N.A  | ....     | D501     | 0402-000546 DIODE-RECTIFIER;TVR10G,400V,1.0A,DO-41,T |        |
| ...3                | IC531    | AA96-50311L ASSY H/S;-AMP,AA62-30175D ,TDA6111Q.HE    | S.N.A  | ....     | D502     | 0402-000546 DIODE-RECTIFIER;TVR10G,400V,1.0A,DO-41,T |        |
| ...3                | IC561    | AA96-50311L ASSY H/S;-AMP,AA62-30175D ,TDA6111Q.HE    | S.N.A  | ....     | D503     | 0402-000493 DIODE-RECTIFIER;1R5GU41,400V,1.5A,DO-15L |        |
| ....4               |          | 1201-001131 IC-VIDEO AMP;6111,SIP,9P,-,SINGLE,-,PLAS  |        | ....     | D504     | 0401-000005 DIODE-SWITCHING;1N4148,100V,200mA,DO-35, |        |
| ....4               |          | 6003-000334 SCREW-TAPTITE;RH,+,2S,M3,L6,ZPC(YEL),SWR  | S.N.A  | ....     | D509     | 0401-000005 DIODE-SWITCHING;1N4148,100V,200mA,DO-35, |        |
| ....4               |          | AA62-30175D HEAT-SINK PS;-SECC,T1.0,-,33X15X30 FT-2   | S.N.A  | ....     | D510     | 0401-000005 DIODE-SWITCHING;1N4148,100V,200mA,DO-35, |        |
| ...3                | Q371     | AA96-00244H ASSY H/S;SCREW,2SC4636(2),CRT,SILICON-OIL | S.N.A  | ....     | D531     | 0402-000546 DIODE-RECTIFIER;TVR10G,400V,1.0A,DO-41,T |        |
| ....4               |          | 0205-000129 GREASE-SILICON;SC102,JAPAN                | S.N.A  | ....     | D532     | 0402-000546 DIODE-RECTIFIER;TVR10G,400V,1.0A,DO-41,T |        |
| ....4               |          | 0502-000442 TR-POWER;2SC4636RB,NPN,2W,TO-220,ST,10-   |        | ....     | D533     | 0402-000493 DIODE-RECTIFIER;1R5GU41,400V,1.5A,DO-15L |        |
| ....4               |          | 6003-000335 SCREW-TAPTITE;RH,+,2S,M3,L8,ZPC(YEL),SWR  | S.N.A  | ....     | D561     | 0402-000546 DIODE-RECTIFIER;TVR10G,400V,1.0A,DO-41,T |        |
| ....4               |          | AA62-00046A HEAT SINK PS;-T1.0,-,D1(DREAM) 60X25X     | S.N.A  | ....     | D562     | 0402-000546 DIODE-RECTIFIER;TVR10G,400V,1.0A,DO-41,T |        |
| ...3                | RPW-SC   | BP39-00004B LEAD CONNECTOR ASSY;P55A/HCM4215W,UL3239  |        | ....     | D563     | 0402-000493 DIODE-RECTIFIER;1R5GU41,400V,1.5A,DO-15L |        |
| ...3                | SCW-GN   | AA39-00198D LEAD CONNECTOR ASSY;P55A/HCM4215W,UL1617  |        | ....     | DZ501    | 0403-000334 DIODE-ZENER;UZZ,7BSA,2.7V,2.54-2.75V,500 |        |
| ...3                | SG301    | 4715-001050 SURGE ABSORBER;2.4kV,20%,1500A,-,DISC-RA  |        | ....     | DZ502    | 0403-000708 DIODE-ZENER;MTZJ13B,13V,12.55-13.21V,500 |        |
| ...3                | SG502    | AA27-00084A COIL;S-23,-,-,-,-,-,S-23,5000Mohm MIN,    |        | ....     | DZ503    | 0403-000334 DIODE-ZENER;UZZ,7BSA,2.7V,2.54-2.75V,500 |        |
| ...3                | SG532    | AA27-00084A COIL;S-23,-,-,-,-,-,S-23,5000Mohm MIN,    |        | ....     | DZ533    | 0403-000708 DIODE-ZENER;MTZJ5.6B,5.6V,5.45-5.73V,500 |        |
| ...3                | SG562    | AA27-00084A COIL;S-23,-,-,-,-,-,S-23,5000Mohm MIN,    |        | ....     | DZ561    | 0403-000334 DIODE-ZENER;UZZ,7BSA,2.7V,2.54-2.75V,500 |        |
| ...3                | V501     | 3704-001019 SOCKET-CRT;10P,29.1PI,35.5PI,AU300U,-     |        | ....     | DZ562    | 0403-000508 DIODE-ZENER;MTZJ5.6B,5.6V,5.45-5.73V,500 |        |
| ...3                | V531     | 3704-001019 SOCKET-CRT;10P,29.1PI,35.5PI,AU300U,-     |        | ....     | DZ563    | 0403-000708 DIODE-ZENER;MTZJ13B,13V,12.55-13.21V,500 |        |
| ...3                | V561     | 3704-001019 SOCKET-CRT;10P,29.1PI,35.5PI,AU300U,-     |        | ....     | EL01     | AA60-40011B EYELET;ID2.2.OD3.2,-,-,BSP-              | S.N.A  |
| ...3                | VR501    | 2101-000321 VR-ROTARY;1Mohm,-,0.6W,SIDE               |        | ....     | EL02     | AA60-40011B EYELET;ID2.2.OD3.2,-,-,BSP-              | S.N.A  |
| ...3                | VR531    | 2101-000321 VR-ROTARY;1Mohm,-,0.6W,SIDE               |        | ....     | EL03     | AA60-40011A EYELET;ID2.0.OD2.8,-,-,BST-              | S.N.A  |
| ...3                | VR561    | 2101-000321 VR-ROTARY;1Mohm,-,0.6W,SIDE               |        | ....     | EL04     | AA60-40011B EYELET;ID2.2.OD3.2,-,-,BSP-              | S.N.A  |
| ...3                |          | 3301-001201 CORE-FERRITE;AE,21x11x32mm,1500,280G      |        | ....     | EL05     | AA60-40011B EYELET;ID2.2.OD3.2,-,-,BSP-              | S.N.A  |
| ...3                |          | AA39-20010B LEAD CONNECTOR-ASSY;,1P,YFH800-01,S,500,  |        | ....     | EL06     | AA60-40011A EYELET;ID2.0.OD2.8,-,-,BST-              | S.N.A  |
| ...3                |          | 0202-000187 SOLDER-WIRE FLUX;-RS60S,D1.2,63Sn/37Pb    | S.N.A  | ....     | EL503    | AA60-40011B EYELET;ID2.2.OD3.2,-,-,BSP-              | S.N.A  |
| ...3                |          | AA97-07608A ASSY AUTO-CRT;HCM4215W                    | S.N.A  | ....     | EL504    | AA60-40011B EYELET;ID2.2.OD3.2,-,-,BSP-              | S.N.A  |
| ....4               | C361     | 2306-000122 C-FILM,MPPF;100nF,5%,50V,TP,7.3x4.0x5.0m  |        | ....     | EL505    | AA60-40011B EYELET;ID2.2.OD3.2,-,-,BSP-              | S.N.A  |
| ....4               | C371     | 2401-000302 C-AL;100uF,20%,25V,GP,TP,6.3x11,5         |        | ....     | EL533    | AA60-40011B EYELET;ID2.2.OD3.2,-,-,BSP-              | S.N.A  |
| ....4               | C372     | 2401-000480 C-AL;10uF,20%,50V,GP,TP,5x11,5            |        | ....     | EL534    | AA60-40011B EYELET;ID2.2.OD3.2,-,-,BSP-              | S.N.A  |
| ....4               | C373     | 2401-000302 C-AL;100uF,20%,25V,GP,TP,6.3x11,5         |        | ....     | EL535    | AA60-40011B EYELET;ID2.2.OD3.2,-,-,BSP-              | S.N.A  |
| ....4               | C374     | 2401-001621 C-AL;6.8uF,20%,450V,GP,TP,13x20,5         |        | ....     | EL536    | AA60-40011B EYELET;ID2.2.OD3.2,-,-,BSP-              | S.N.A  |
| ....4               | C376     | 2201-000556 C-CERAMIC,DISC;0.47nF,10%,500V,Y5P,TP,5   |        | ....     | EL537    | AA60-40011B EYELET;ID2.2.OD3.2,-,-,BSP-              | S.N.A  |
| ....4               | C502     | 2401-000027 C-AL;4.7uF,20%,50V,GP,TP,5x11,5           |        | ....     | EL563    | AA60-40011B EYELET;ID2.2.OD3.2,-,-,BSP-              | S.N.A  |
| ....4               | C503     | 2201-000119 C-CERAMIC,DISC;100nF,+80-20%,50V,Y5V,TP,  |        | ....     | EL564    | AA60-40011B EYELET;ID2.2.OD3.2,-,-,BSP-              | S.N.A  |
| ....4               | C504     | 2401-001571 C-AL;47uF,+20%-0%,50V,GP,TP,8x11.5        |        | ....     | EL565    | AA60-40011B EYELET;ID2.0.OD3.2,-,-,BSP-              | S.N.A  |
| ....4               | C505     | 2305-000149 C-FILM,MPEF;100nF,5%,100V,TP,12x12.5x6.5  |        | ....     | EL566    | AA60-40011B EYELET;ID2.2.OD3.2,-,-,BSP-              | S.N.A  |
| ....4               | C506     | 2401-000430 C-AL;10uF,20%,250V,GP,TP,10x16mm,5m       |        | ....     | EL567    | AA60-40011B EYELET;ID2.2.OD3.2,-,-,BSP-              | S.N.A  |
| ....4               | C507     | 2305-000154 C-FILM,MPEF;100nF,5%,400V,TP,21.5x6.5x11  |        | ....     | GT371    | AA60-40014A PIN-GT,ASSY;1P,-,-,AUTO                  | S.N.A  |
| ....4               | C510     | 2401-000430 C-AL;10uF,20%,250V,GP,TP,10x16mm,5m       |        | ....     | GT372    | AA60-40014A PIN-GT,ASSY;1P,-,-,AUTO                  | S.N.A  |
| ....4               | C511     | 2201-000723 C-CERAMIC,DISC;4.7nF,20%,3KV,Y5U,TP,16x5  |        | ....     | GT373    | AA60-40014A PIN-GT,ASSY;1P,-,-,AUTO                  | S.N.A  |
| ....4               | C512     | 2401-000133 C-AL;1000uF,20%,16V,GP,TP,10x20,5         |        | ....     | GT374    | AA60-40014A PIN-GT,ASSY;1P,-,-,AUTO                  | S.N.A  |
| ....4               | C513     | 2201-000983 C-CERAMIC,DISC;1nF,10%,2kV,Y5P,TP,9x5,7   |        | ....     | GT501    | AA60-40014A PIN-GT,ASSY;1P,-,-,AUTO                  | S.N.A  |
| ....4               | C514     | 2201-000599 C-CERAMIC,DISC;0.56nF,10%,500V,Y5P,TP,5   |        | ....     | GT502    | AA60-40014A PIN-GT,ASSY;1P,-,-,AUTO                  | S.N.A  |
| ....4               | C532     | 2401-000027 C-AL;4.7uF,20%,50V,GP,TP,5x11,5           |        | ....     | GT503    | AA60-40014A PIN-GT,ASSY;1P,-,-,AUTO                  | S.N.A  |
| ....4               | C533     | 2201-000119 C-CERAMIC,DISC;100nF,+80-20%,50V,Y5V,TP,  |        | ....     | GT504    | AA60-40014A PIN-GT,ASSY;1P,-,-,AUTO                  | S.N.A  |
| ....4               | C534     | 2401-001571 C-AL;47uF,+20%-0%,50V,GP,TP,8x11.5        |        | ....     | GT506    | AA60-40014A PIN-GT,ASSY;1P,-,-,AUTO                  | S.N.A  |
| ....4               | C535     | 2305-000149 C-FILM,MPEF;100nF,5%,100V,TP,12x12.5x6.5  |        | ....     | GT531    | AA60-40014A PIN-GT,ASSY;1P,-,-,AUTO                  | S.N.A  |
| ....4               | C536     | 2401-000430 C-AL;10uF,20%,250V,GP,TP,10x16mm,5m       |        | ....     | GT532    | AA60-40014A PIN-GT,ASSY;1P,-,-,AUTO                  | S.N.A  |
| ....4               | C537     | 2305-000154 C-FILM,MPEF;100nF,5%,400V,TP,21.5x6.5x11  |        | ....     | GT533    | AA60-40014A PIN-GT,ASSY;1P,-,-,AUTO                  | S.N.A  |
| ....4               |          |   |        | ....     | GT534    | AA60-40014A PIN-GT,ASSY;1P,-,-,AUTO                  | S.N.A  |

Electrical Parts List

| Loc. No. | Code No. | Description ; Specification                          | Remark | Loc. No. | Code No.    | Description ; Specification                                | Remark |
|----------|----------|--|--------|----------|-------------|--|--------|
| ....4    | GT535    | AA60-40014A PIN-GT,ASSY;1P,-,AUTO                    | S.N.A  | ....4    | R534        | 2001-000563 R-CARBON;27KOHM,5%,1/8W,AA,TP,1.8X3.2MM        |        |
| ....4    | GT536    | AA60-40014A PIN-GT,ASSY;1P,-,AUTO                    | S.N.A  | ....4    | R536        | 2001-001049 R-CARBON(S);1.3KOHM,5%,1/2W,AA,TP,2.4X6.       |        |
| ....4    | GT537    | AA60-40014A PIN-GT,ASSY;1P,-,AUTO                    | S.N.A  | ....4    | R537        | 2001-001088 R-CARBON(S);1KOHM,5%,1/2W,AA,TP,2.4X6.4M       |        |
| ....4    | GT561    | AA60-40014A PIN-GT,ASSY;1P,-,AUTO                    | S.N.A  | ....4    | R538        | 2003-000738 R-METAL OXIDE(S);56Kohm,5%,2W,AA,TP,4x12       |        |
| ....4    | GT562    | AA60-40014A PIN-GT,ASSY;1P,-,AUTO                    | S.N.A  | ....4    | R540        | 2001-000908 R-CARBON;62KOHM,5%,1/8W,AA,TP,1.8X3.2MM        |        |
| ....4    | GT563    | AA60-40014A PIN-GT,ASSY;1P,-,AUTO                    | S.N.A  | ....4    | R541        | 2001-000009 R-CARBON;20KOHM,5%,1/8W,AA,TP,1.8X3.2MM        |        |
| ....4    | GT564    | AA60-40014A PIN-GT,ASSY;1P,-,AUTO                    | S.N.A  | ....4    | R542        | 2001-000890 R-CARBON;6.8KOHM,5%,1/8W,AA,TP,1.8X3.2MM       |        |
| ....4    | GT567    | AA60-40014A PIN-GT,ASSY;1P,-,AUTO                    | S.N.A  | ....4    | R543        | 2008-001129 R-FUSIBLE(S);1.5ohm,5%,1/2W,AF,TP,2.5x6.       |        |
| ....4    | GT568    | AA60-40014A PIN-GT,ASSY;1P,-,AUTO                    | S.N.A  | ....4    | R544        | 2001-001122 R-CARBON(S);3.9KOHM,5%,1/2W,AA,TP,2.4X6.       |        |
| ....4    | L501     | 2701-000114 INDUCTOR-AXIAL;10uH,10%,2.5x3.4mm        |        | ....4    | R545        | 2002-001017 R-COMPOSITION;1Kohm,10%,1/2W,AA,TP,3.7x9       |        |
| ....4    | L531     | 2701-000114 INDUCTOR-AXIAL;10uH,10%,2.5x3.4mm        |        | ....4    | R546        | 2001-000009 R-CARBON;20KOHM,5%,1/8W,AA,TP,1.8X3.2MM        |        |
| ....4    | L561     | 2701-000168 INDUCTOR-AXIAL;3.3uH,5%,2.5x3.4mm        |        | ....4    | R547        | 2001-000085 R-CARBON(S);100KOHM,5%,1/2W,AA,TP,2.4X6.       |        |
| ....4    | PCB      | AA41-00600A PCB-CRT,FR-1,1L,A,1.6T,245X245,COMMANDO  | S.N.A  | ....4    | R548        | 2002-001021 R-COMPOSITION;560KOHM,10%,1/2W,AA,TP,3.7       |        |
| ....4    | Q361     | 0501-000283 TR-SMALL SIGNAL;KSA539,PNP,400mW,TO-92,T |        | ....4    | R549        | 2002-001021 R-COMPOSITION;560KOHM,10%,1/2W,AA,TP,3.7       |        |
| ....4    | Q362     | 0501-000366 TR-SMALL SIGNAL;KSC2330-Y,NPN,1W,TO-92L, |        | ....4    | R550        | 2001-000066 R-CARBON(S);10KOHM,5%,1/2W,AA,TP,2.4X6.4       |        |
| ....4    | Q501     | 0502-000006 TR-POWER;KSC1507,NPN,15W,TO-220,TP,120-  |        | ....4    | R551        | 2001-001052 R-CARBON(S);1.5MOHM,5%,1/2W,AA,TP,2.4X6.       |        |
| ....4    | Q502     | 0501-000389 TR-SMALL SIGNAL;KSC815,NPN,400mW,TO-92,T |        | ....4    | R552        | 2002-001006 R-COMPOSITION;4.7KOHM,15%,1/2W,AA,TP,3.7       |        |
| ....4    | Q504     | 0501-000283 TR-SMALL SIGNAL;KSA539,PNP,400mW,TO-92,T |        | ....4    | R553        | 2002-001006 R-COMPOSITION;4.7KOHM,15%,1/2W,AA,TP,3.7       |        |
| ....4    | Q531     | 0502-000006 TR-POWER;KSC1507,NPN,15W,TO-220,TP,120-  |        | ....4    | R554        | 2001-000028 R-CARBON(S);1000HM,5%,1/2W,AA,TP,2.4X6.4       |        |
| ....4    | Q533     | 0501-000283 TR-SMALL SIGNAL;KSA539,PNP,400mW,TO-92,T |        | ....4    | R555        | 2001-000734 R-CARBON;4.7KOHM,5%,1/8W,AA,TP,1.8X3.2MM       |        |
| ....4    | Q534     | 0501-000283 TR-SMALL SIGNAL;KSA539,PNP,400mW,TO-92,T |        | ....4    | R556        | 2001-000007 R-CARBON;3KOHM,5%,1/8W,AA,TP,1.8X3.2MM         |        |
| ....4    | Q561     | 0502-000006 TR-POWER;KSC1507,NPN,15W,TO-220,TP,120-  |        | ....4    | R557        | 2001-000362 R-CARBON;1500HM,5%,1/8W,AA,TP,1.8X3.2MM        |        |
| ....4    | Q563     | 0501-000283 TR-SMALL SIGNAL;KSA539,PNP,400mW,TO-92,T |        | ....4    | R558        | 2001-000319 R-CARBON;120KOHM,5%,1/8W,AA,TP,1.8X3.2MM       |        |
| ....4    | R361     | 2001-001097 R-CARBON(S);2.4KOHM,5%,1/2W,AA,TP,2.4X6. |        | ....4    | R559        | 2002-001015 R-COMPOSITION;47Kohm,5%,1/2W,AA,TP,3.7x9       |        |
| ....4    | R362     | 2001-000660 R-CARBON;33KOHM,5%,1/8W,AA,TP,1.8X3.2MM  |        | ....4    | R562        | 2001-000232 R-CARBON;1.3KOHM,5%,1/8W,AA,TP,1.8X3.2MM       |        |
| ....4    | R363     | 2001-000723 R-CARBON;4.3KOHM,5%,1/8W,AA,TP,1.8X3.2MM |        | ....4    | R563        | 2001-000429 R-CARBON;1KOHM,5%,1/8W,AA,TP,1.8X3.2MM         |        |
| ....4    | R364     | 2001-000938 R-CARBON;680HM,5%,1/8W,AA,TP,1.8X3.2MM   |        | ....4    | R564        | 2001-000908 R-CARBON;62KOHM,5%,1/8W,AA,TP,1.8X3.2MM        |        |
| ....4    | R365     | 2001-001120 R-CARBON(S);3.30HM,5%,1/2W,AA,TP,2.4X6.4 |        | ....4    | R566        | 2001-001049 R-CARBON(S);1.3KOHM,5%,1/2W,AA,TP,2.4X6.       |        |
| ....4    | R366     | 2001-000109 R-CARBON(S);4700HM,5%,1/2W,AA,TP,2.4X6.4 |        | ....4    | R567        | 2001-001088 R-CARBON(S);1KOHM,5%,1/2W,AA,TP,2.4X6.4M       |        |
| ....4    | R367     | 2001-001065 R-CARBON(S);110KOHM,5%,1/2W,AA,TP,2.4X6. |        | ....4    | R568        | 2001-000734 R-CARBON;4.7KOHM,5%,1/8W,AA,TP,1.8X3.2MM       |        |
| ....4    | R368     | 2001-001065 R-CARBON(S);110KOHM,5%,1/2W,AA,TP,2.4X6. |        | ....4    | R569        | 2001-000472 R-CARBON;2.7KOHM,5%,1/8W,AA,TP,1.8X3.2MM       |        |
| ....4    | R369     | 2001-001065 R-CARBON(S);110KOHM,5%,1/2W,AA,TP,2.4X6. |        | ....4    | R570        | 2001-000362 R-CARBON;1500HM,5%,1/8W,AA,TP,1.8X3.2MM        |        |
| ....4    | R369A    | 2001-001065 R-CARBON(S);110KOHM,5%,1/2W,AA,TP,2.4X6. |        | ....4    | R571        | 2001-000281 R-CARBON;1000HM,5%,1/8W,AA,TP,1.8X3.2MM        |        |
| ....4    | R370     | 2001-001065 R-CARBON(S);110KOHM,5%,1/2W,AA,TP,2.4X6. |        | ....4    | R573        | 2008-001129 R-FUSIBLE(S);1.5ohm,5%,1/2W,AF,TP,2.5x6.       |        |
| ....4    | R371     | 2001-001065 R-CARBON(S);110KOHM,5%,1/2W,AA,TP,2.4X6. |        | ....4    | R574        | 2001-001122 R-CARBON(S);3.9KOHM,5%,1/2W,AA,TP,2.4X6.       |        |
| ....4    | R372     | 2001-001110 R-CARBON(S);240KOHM,5%,1/2W,AA,TP,2.4X6. |        | ....4    | R575        | 2002-001017 R-COMPOSITION;1Kohm,10%,1/2W,AA,TP,3.7x9       |        |
| ....4    | R373     | 2001-001110 R-CARBON(S);240KOHM,5%,1/2W,AA,TP,2.4X6. |        | ....4    | R576        | 2001-000009 R-CARBON;20KOHM,5%,1/8W,AA,TP,1.8X3.2MM        |        |
| ....4    | R374     | 2001-001110 R-CARBON(S);240KOHM,5%,1/2W,AA,TP,2.4X6. |        | ....4    | R577        | 2001-000085 R-CARBON(S);100KOHM,5%,1/2W,AA,TP,2.4X6.       |        |
| ....4    | R375     | 2001-001113 R-CARBON(S);270KOHM,5%,1/2W,AA,TP,2.4X6. |        | ....4    | R578        | 2002-001021 R-COMPOSITION;560KOHM,10%,1/2W,AA,TP,3.7       |        |
| ....4    | R376     | 2001-000613 R-CARBON;3.9KOHM,5%,1/8W,AA,TP,1.8X3.2MM |        | ....4    | R579        | 2002-001021 R-COMPOSITION;560KOHM,10%,1/2W,AA,TP,3.7       |        |
| ....4    | R377     | 2004-001892 R-METAL(S);162Kohm,1%,1/2W,AA,TP,2.5x6.5 |        | ....4    | R580        | 2001-000066 R-CARBON(S);10KOHM,5%,1/2W,AA,TP,2.4X6.4       |        |
| ....4    | R378     | 2004-001892 R-METAL(S);162Kohm,1%,1/2W,AA,TP,2.5x6.5 |        | ....4    | R581        | 2001-001052 R-CARBON(S);1.5MOHM,5%,1/2W,AA,TP,2.4X6.       |        |
| ....4    | R379     | 2004-001892 R-METAL(S);162Kohm,1%,1/2W,AA,TP,2.5x6.5 |        | ....4    | R582        | 2002-001006 R-COMPOSITION;4.7KOHM,15%,1/2W,AA,TP,3.7       |        |
| ....4    | R380     | 2004-001892 R-METAL(S);162Kohm,1%,1/2W,AA,TP,2.5x6.5 |        | ....4    | R583        | 2002-001006 R-COMPOSITION;4.7KOHM,15%,1/2W,AA,TP,3.7       |        |
| ....4    | R381     | 2001-001088 R-CARBON(S);1KOHM,5%,1/2W,AA,TP,2.4X6.4M |        | ....4    | R584        | 2001-000028 R-CARBON(S);1000HM,5%,1/2W,AA,TP,2.4X6.4       |        |
| ....4    | R382     | 2002-001006 R-COMPOSITION;4.7KOHM,15%,1/2W,AA,TP,3.7 |        | ....4    | R588        | 2003-000738 R-METAL OXIDE(S);56Kohm,5%,2W,AA,TP,4x12       |        |
| ....4    | R500     | 2001-000613 R-CARBON;3.9KOHM,5%,1/8W,AA,TP,1.8X3.2MM |        | ....4    | R589        | 2002-001015 R-COMPOSITION;47Kohm,5%,1/2W,AA,TP,3.7x9       |        |
| ....4    | R502     | 2001-000995 R-CARBON;820OHM,5%,1/8W,AA,TP,1.8X3.2MM  |        | ....4    | SG501       | 4715-001036 SURGE ABSORBER;500V,20%,-,TP                   |        |
| ....4    | R503     | 2001-000429 R-CARBON;1KOHM,5%,1/8W,AA,TP,1.8X3.2MM   |        | ....4    | SG503       | 4715-001036 SURGE ABSORBER;500V,20%,-,TP                   |        |
| ....4    | R504     | 2001-000006 R-CARBON;2.4KOHM,5%,1/8W,AA,TP,1.8X3.2MM |        | ....4    | SG531       | 4715-001036 SURGE ABSORBER;500V,20%,-,TP                   |        |
| ....4    | R505     | 2001-000362 R-CARBON;1500HM,5%,1/8W,AA,TP,1.8X3.2MM  |        | ....4    | SG533       | 4715-001036 SURGE ABSORBER;500V,20%,-,TP                   |        |
| ....4    | R506     | 2001-001049 R-CARBON(S);1.3KOHM,5%,1/2W,AA,TP,2.4X6. |        | ....4    | SG561       | 4715-001036 SURGE ABSORBER;500V,20%,-,TP                   |        |
| ....4    | R507     | 2001-001088 R-CARBON(S);1KOHM,5%,1/2W,AA,TP,2.4X6.4M |        | ....4    | SG563       | 4715-001036 SURGE ABSORBER;500V,20%,-,TP                   |        |
| ....4    | R508     | 2003-000738 R-METAL OXIDE(S);56Kohm,5%,2W,AA,TP,4x12 |        | ....3    | BP59-00005A | MODULE-FOCUS PACK ASS'Y;PJT TV;F301-P03A                   |        |
| ....4    | R509     | 2001-000734 R-CARBON;4.7KOHM,5%,1/8W,AA,TP,1.8X3.2MM |        | ....2    | AA95-02002A | ASSY SUB-PCB,CG AMP,COMMANDO                               |        |
| ....4    | R510     | 2001-000908 R-CARBON;62KOHM,5%,1/8W,AA,TP,1.8X3.2MM  |        | ....3    | BNW01       | BP39-00005A LEAD CONNECTOR ASSY;P55A/HCM4215W,UL2547       |        |
| ....4    | R511     | 2001-000281 R-CARBON;100OHM,5%,1/8W,AA,TP,1.8X3.2MM  |        | ....3    | BNW03       | BP39-00015A LEAD CONNECTOR ASSY;P55A/HCM4215W,UL1185       |        |
| ....4    | R513     | 2008-001129 R-FUSIBLE(S);1.5ohm,5%,1/2W,AF,TP,2.5x6. |        | ....3    | CNZ01       | 3711-003046 CONNECTOR-HEADER;BOX,9P,1R,2.5mm,STRAIGH       |        |
| ....4    | R514     | 2001-001122 R-CARBON(S);3.9KOHM,5%,1/2W,AA,TP,2.4X6. |        | ....3    | CNZ02       | 3711-003043 CONNECTOR-HEADER;BOX,4P,1R,2.5mm,STRAIGH       |        |
| ....4    | R515     | 2002-001017 R-COMPOSITION;1Kohm,10%,1/2W,AA,TP,3.7x9 |        | ....3    | CNZ03       | 3711-003043 CONNECTOR-HEADER;BOX,4P,1R,2.5mm,STRAIGH       |        |
| ....4    | R516     | 2001-000009 R-CARBON;20KOHM,5%,1/8W,AA,TP,1.8X3.2MM  |        | ....3    | CNZ04       | 3711-003043 CONNECTOR-HEADER;BOX,4P,1R,2.5mm,STRAIGH       |        |
| ....4    | R517     | 2001-000085 R-CARBON(S);100KOHM,5%,1/2W,AA,TP,2.4X6. |        | ....3    | CNZ05       | 3711-003043 CONNECTOR-HEADER;BOX,4P,1R,2.5mm,STRAIGH       |        |
| ....4    | R518     | 2002-001021 R-COMPOSITION;560KOHM,10%,1/2W,AA,TP,3.7 |        | ....3    | CZ101       | BP96-00005A ASSY HEAT SINK P;BP62-00002A,SCREW,STK39       | S.N.A  |
| ....4    | R519     | 2002-001021 R-COMPOSITION;560KOHM,10%,1/2W,AA,TP,3.7 |        | ....4    | CIS         | 1201-001225 IC-VIDEO AMP;392,SIF,22P,-,TRIPLE,-,PLAS       |        |
| ....4    | R520     | 2001-000066 R-CARBON(S);10KOHM,5%,1/2W,AA,TP,2.4X6.4 |        | ....4    | CIS         | BP73-00002A SILICON/RUBBER;COMMANDO CG AMP,SILICON , S.N.A |        |
| ....4    | R521     | 2001-001052 R-CARBON(S);1.5MOHM,5%,1/2W,AA,TP,2.4X6. |        | ....4    | CIS         | BP62-00008A HEAT SINK;COMMANDO CG AMP,AL6063,T2.0,W1       | S.N.A  |
| ....4    | R522     | 2002-001006 R-COMPOSITION;4.7KOHM,15%,1/2W,AA,TP,3.7 |        | ....4    | CIS         | BP62-00002A HEAT SINK;COMMANDO,A1050P,T2.0,W62.0,H14       | S.N.A  |
| ....4    | R523     | 2002-001006 R-COMPOSITION;4.7KOHM,15%,1/2W,AA,TP,3.7 |        | ....4    | CIS         | 6003-001021 SCREW-TAPTITE;RH,+B,M3,L15,ZPC(YEL),SWR        | S.N.A  |
| ....4    | R524     | 2001-000028 R-CARBON(S);1000HM,5%,1/2W,AA,TP,2.4X6.4 |        | ....3    |             | AA65-30110A CLAMP-WIRE;ALL MODEL,NYLON 66,V2,-,BLK,P       | S.N.A  |
| ....4    | R526     | 2001-000539 R-CARBON;24KOHM,5%,1/8W,AA,TP,1.8X3.2MM  |        | ....3    |             | BP61-00076A HOLDER-PUSH,A;42W5,NYLON6.6,NATURAL            | S.N.A  |
| ....4    | R527     | 2001-000577 R-CARBON;2KOHM,5%,1/8W,AA,TP,1.8X3.2MM   |        | ....3    |             | BP61-00077A HOLDER-PUSH,B;42W5,NYLON6.6,NATURAL            | S.N.A  |
| ....4    | R528     | 2001-001015 R-CARBON;9.1KOHM,5%,1/8W,AA,TP,1.8X3.2MM |        | ....3    |             | 0202-000187 SOLDER-WIRE FLUX;-RS60S,D1.2.63Sn/37Pb         | S.N.A  |
| ....4    | R529     | 2002-001021 R-COMPOSITION;560KOHM,10%,1/2W,AA,TP,3.7 |        | ....3    |             | AA97-07418A ASSY AUTO;0000                                 | S.N.A  |
| ....4    | R530     | 2001-000429 R-CARBON;1KOHM,5%,1/8W,AA,TP,1.8X3.2MM   |        | ....4    | C866        | 2401-000183 C-AL;1000uF,20%,35V,WT,TP,12.5x25.5            |        |
| ....4    | R531     | 2001-000290 R-CARBON;10KOHM,5%,1/8W,AA,TP,1.8X3.2MM  |        | ....4    | C869        | 2401-000183 C-AL;1000uF,20%,35V,WT,TP,12.5x25.5            |        |
| ....4    | R532     | 2001-000995 R-CARBON;820OHM,5%,1/8W,AA,TP,1.8X3.2MM  |        | ....4    | CZ108       | 2202-000863 C-CERAMIC,MLC-AXIAL;560pF,10%,50V,Y5P,TP       |        |
| ....4    | R533     | 2001-000429 R-CARBON;1KOHM,5%,1/8W,AA,TP,1.8X3.2MM   |        | ....4    | CZ109       | 2202-000863 C-CERAMIC,MLC-AXIAL;560pF,10%,50V,Y5P,TP       |        |

| Loc. No. | Code No. | Description ; Specification                          | Remark | Loc. No. | Code No.    | Description ; Specification                          | Remark |
|----------|----------|--|--------|----------|-------------|--|--------|
| ...4     | CZ110    | 2202-000863 C-CERAMIC,MLC-AXIAL;560pF,10%,50V,Y5P,TP |        | ...4     | RZ132       | 2003-002171 R-METAL OXIDE(S);150ohm,5%,2W,AG,TP,3.9x |        |
| ...4     | CZ111    | 2202-000205 C-CERAMIC,MLC-AXIAL;22pF,5%,50V,SL,TP,1  |        | ...4     | RZ132A      | 2003-002171 R-METAL OXIDE(S);150ohm,5%,2W,AG,TP,3.9x |        |
| ...4     | CZ112    | 2202-000825 C-CERAMIC,MLC-AXIAL;680pF,10%,50V,Y5P,TP |        | ...4     | RZ133       | 2001-000563 R-CARBON;27KOHM,5%,1/8W,AA,TP,1.8X3.2MM  |        |
| ...4     | CZ113    | 2202-000561 C-CERAMIC,MLC-RADIAL;680pF,5%,50V,NPO,TP |        | ...4     | RZ134       | 2001-000563 R-CARBON;27KOHM,5%,1/8W,AA,TP,1.8X3.2MM  |        |
| ...4     | CZ114    | 2202-000561 C-CERAMIC,MLC-RADIAL;680pF,5%,50V,NPO,TP |        | ...4     | RZ135       | 2001-000563 R-CARBON;27KOHM,5%,1/8W,AA,TP,1.8X3.2MM  |        |
| ...4     | CZ115    | 2202-000205 C-CERAMIC,MLC-AXIAL;22pF,5%,50V,SL,TP,1  |        | ...4     | RZ136       | 2001-000591 R-CARBON;3.3KOHM,5%,1/8W,AA,TP,1.8X3.2MM |        |
| ...4     | CZ116    | 2202-000825 C-CERAMIC,MLC-AXIAL;680pF,10%,50V,Y5P,TP |        | ...4     | RZ137       | 2001-000857 R-CARBON;560OHM,5%,1/8W,AA,TP,1.8X3.2MM  |        |
| ...4     | CZ117    | 2201-000327 C-CERAMIC,DISC;2.2nF,10%,50V,Y5V,TP,6.5x |        | ...4     | RZ138       | 2001-000591 R-CARBON;3.3KOHM,5%,1/8W,AA,TP,1.8X3.2MM |        |
| ...4     | CZ118    | 2201-000327 C-CERAMIC,DISC;2.2nF,10%,50V,Y5V,TP,6.5x |        | ...4     | RZ139       | 2001-000857 R-CARBON;560OHM,5%,1/8W,AA,TP,1.8X3.2MM  |        |
| ...4     | CZ126    | 2202-000863 C-CERAMIC,MLC-AXIAL;560pF,10%,50V,Y5P,TP |        | ...4     | RZ140       | 2001-000591 R-CARBON;3.3KOHM,5%,1/8W,AA,TP,1.8X3.2MM |        |
| ...4     | CZ127    | 2202-000863 C-CERAMIC,MLC-AXIAL;560pF,10%,50V,Y5P,TP |        | ...4     | RZ141       | 2001-000857 R-CARBON;560OHM,5%,1/8W,AA,TP,1.8X3.2MM  |        |
| ...4     | CZ128    | 2202-000863 C-CERAMIC,MLC-AXIAL;560pF,10%,50V,Y5P,TP |        | ...4     | RZ142       | 2003-002148 R-METAL OXIDE;3.9OHM,2%,2W,AF,TP,3.9X10M |        |
| ...4     | CZ132    | 2202-000205 C-CERAMIC,MLC-AXIAL;22pF,5%,50V,SL,TP,1  |        | ...4     | RZ143       | 2003-002148 R-METAL OXIDE;3.9OHM,2%,2W,AF,TP,3.9X10M |        |
| ...4     | CZ133    | 2202-000825 C-CERAMIC,MLC-AXIAL;680pF,10%,50V,Y5P,TP |        | ...4     | RZ144       | 2003-002148 R-METAL OXIDE;3.9OHM,2%,2W,AF,TP,3.9X10M |        |
| ...4     | CZ134    | 2202-000205 C-CERAMIC,MLC-AXIAL;22pF,5%,50V,SL,TP,1  |        | ...4     | RZ145       | 2003-002148 R-METAL OXIDE;3.9OHM,2%,2W,AF,TP,3.9X10M |        |
| ...4     | CZ135    | 2202-000825 C-CERAMIC,MLC-AXIAL;680pF,10%,50V,Y5P,TP |        | ...4     | RZ146       | 2003-002148 R-METAL OXIDE;3.9OHM,2%,2W,AF,TP,3.9X10M |        |
| ...4     | CZ136    | 2202-000205 C-CERAMIC,MLC-AXIAL;22pF,5%,50V,SL,TP,1  |        | ...4     | RZ147       | 2003-002148 R-METAL OXIDE;3.9OHM,2%,2W,AF,TP,3.9X10M |        |
| ...4     | CZ137    | 2202-000825 C-CERAMIC,MLC-AXIAL;680pF,10%,50V,Y5P,TP |        | ...4     | RZ148       | 2003-002171 R-METAL OXIDE(S);150ohm,5%,2W,AG,TP,3.9x |        |
| ...4     | CZ138    | 2201-000327 C-CERAMIC,DISC;2.2nF,10%,50V,Y5V,TP,6.5x |        | ...4     | RZ148A      | 2003-002171 R-METAL OXIDE(S);150ohm,5%,2W,AG,TP,3.9x |        |
| ...4     | CZ139    | 2201-000327 C-CERAMIC,DISC;2.2nF,10%,50V,Y5V,TP,6.5x |        | ...4     | RZ149       | 2003-002171 R-METAL OXIDE(S);150ohm,5%,2W,AG,TP,3.9x |        |
| ...4     | CZ140    | 2401-000962 C-AL;22uF,20%,50V,GP,TP,5x11,5           |        | ...4     | RZ149A      | 2003-002171 R-METAL OXIDE(S);150ohm,5%,2W,AG,TP,3.9x |        |
| ...4     | CZ141    | 2401-000962 C-AL;22uF,20%,50V,GP,TP,5x11,5           |        | ..2      | AA96-00156A | ASSY-POWER,CORD,-,EP2/(YES(US),H/C)100MM,K           | S.N.A  |
| ...4     | CZ151    | 2202-000121 C-CERAMIC,MLC-AXIAL;100pF,10%,50V,Y5P,TP |        | ..3      | 3301-001201 | CORE-FERRITE;AE,21x11x32mm,1500,280G                 |        |
| ...4     | CZ152    | 2202-000121 C-CERAMIC,MLC-AXIAL;100pF,10%,50V,Y5P,TP |        | ..3      | AA61-20284A | HOLDER,P-CORD,PP,-,-,BLK,VO,KE-002                   | S.N.A  |
| ...4     | CZ153    | 2202-000121 C-CERAMIC,MLC-AXIAL;100pF,10%,50V,Y5P,TP |        | ..3      | AA39-10007Y | POWER-CORD,-,EP2/(YES,SPT-2)18AWGx2C,2.4m            |        |
| ...4     | CZ154    | 2202-000121 C-CERAMIC,MLC-AXIAL;100pF,10%,50V,Y5P,TP |        | ..3      | 3811-000401 | WIRE-PVC CU;BCWA,300V,ROLL,17/0.16mm,#22             | S.N.A  |
| ...4     | CZ155    | 2202-000121 C-CERAMIC,MLC-AXIAL;100pF,10%,50V,Y5P,TP |        | ..2      | BP94-00079A | ASSY PCB MAIN;HCM422XW/XAA,P55A                      |        |
| ...4     | CZ156    | 2202-000121 C-CERAMIC,MLC-AXIAL;100pF,10%,50V,Y5P,TP |        | ..3      | C681        | 2401-000737 C-AL;2200uF,20%,50V,GP,TP,18x35.5,7      |        |
| ...4     | ELZ01    | AA60-40011A EYELET;ID2.0,OD2.8,-,-,BST,-             | S.N.A  | ..3      | C801        | 2401-001068 C-AL;3300uF,20%,50V,GP,BK,22x40,10       |        |
| ...4     | ELZ02    | AA60-40011A EYELET;ID2.0,OD2.8,-,-,BST,-             | S.N.A  | ..3      | CN901       | 3703-001187 CONNECTOR-DIN;64P2R,FEMALE,STRAIGHT,AUF  |        |
| ...4     | ELZ03    | AA60-40011A EYELET;ID2.0,OD2.8,-,-,BST,-             | S.N.A  | ..3      | CNW01       | 3703-001150 CONNECTOR-DIN;32P2R,FEMALE,STRAIGHT,AUF  |        |
| △        | FD101S   | 3601-001065 FUSE-AXIAL LEAD;125V,3.5A,FAST-ACTING,CE |        | ..3      | CNW02       | 3703-001150 CONNECTOR-DIN;32P2R,FEMALE,STRAIGHT,AUF  |        |
| △        | FD102S   | 3601-001065 FUSE-AXIAL LEAD;125V,3.5A,FAST-ACTING,CE |        | ..3      | CNZ01       | 3703-001150 CONNECTOR-DIN;32P2R,FEMALE,STRAIGHT,AUF  |        |
| ...4     | LZ107    | 2701-000142 INDUCTOR-AXIAL;1uH,10%,2.5x3.4mm         |        | ..3      | IC601       | AA96-00623E ASSY H/S;SCREW,MAIN,AA62-00056A,TDA7265, | S.N.A  |
| ...4     | LZ108    | 2701-000142 INDUCTOR-AXIAL;1uH,10%,2.5x3.4mm         |        | ...4     | 0205-000129 | GREASE-SILICON;SC102,JAPAN                           | S.N.A  |
| ...4     | LZ109    | 2701-000142 INDUCTOR-AXIAL;1uH,10%,2.5x3.4mm         |        | ...4     | 1201-001026 | IC-POWER AMP;7265,ZIP,11P,19.6MIL,DUAL,1             |        |
| ...4     | LZ110    | 2701-000142 INDUCTOR-AXIAL;1uH,10%,2.5x3.4mm         |        | ...4     | 6003-000334 | SCREW-TAPTITE;RH,+2S,M3,L6,ZPC(YEL),SWR              | S.N.A  |
| ...4     | LZ111    | 2701-000142 INDUCTOR-AXIAL;1uH,10%,2.5x3.4mm         |        | ...4     | AA62-00056A | HEAT SINK-PS,-,T1.0,-.41*35*70,D2,-,-,               | S.N.A  |
| ...4     | LZ112    | 2701-000142 INDUCTOR-AXIAL;1uH,10%,2.5x3.4mm         |        | △        | IC801       | AA96-00475C ASSY H/S;SILICON-OIL,KA278R09,KA7808,AA6 | S.N.A  |
| ...4     | PCB      | AA41-00601A PCB-CG AMP,,CEM-1,1L,A,1.6T,245X245,COMM | S.N.A  | ...4     | 1203-001978 | IC-VOLTAGE REGULATOR;KA278RA05,T0-220F,4             |        |
| ...4     | R856     | 2001-001155 R-CARBON(S);5.6KOHM,5%,1/2W,AA,TP,2.4X6  |        | ...4     | AA62-00066B | HEAT SINK;D2,D3,AL,T1.0,89,70,-,AA62-00              | S.N.A  |
| ...4     | R857     | 2001-001155 R-CARBON(S);5.6KOHM,5%,1/2W,AA,TP,2.4X6  |        | ...4     | 6003-000334 | SCREW-TAPTITE;RH,+2S,M3,L6,ZPC(YEL),SWR              | S.N.A  |
| ...4     | RFZ19    | 2008-000261 R-FUSIBLE(S);150ohm,5%,1W,AF,TP,3.9x10mm |        | ...4     | 1203-002003 | IC-VOLTAGE REGULATOR;278R09,T0-220,4P,-,             |        |
| ...4     | RFZ20    | 2008-000261 R-FUSIBLE(S);150ohm,5%,1W,AF,TP,3.9x10mm |        | ...4     | 1203-000293 | IC-POS.FIXED REG.;7808,T0-220,3P,-,PLAS              |        |
| ...4     | RFZ21    | 2008-000261 R-FUSIBLE(S);150ohm,5%,1W,AF,TP,3.9x10mm |        | ...4     | 0205-000129 | GREASE-SILICON;SC102,JAPAN                           | S.N.A  |
| ...4     | RFZ22    | 2008-000261 R-FUSIBLE(S);150ohm,5%,1W,AF,TP,3.9x10mm |        | △        | IC802       | 1203-000119 IC-NEGA.FIXED REG.;7905,T0-220,3P,-,PLAS |        |
| ...4     | RFZ50    | 2008-000261 R-FUSIBLE(S);150ohm,5%,1W,AF,TP,3.9x10mm |        | △        | IC808       | BP96-00020G ASSY HEAT SINK P;AA62-00045B,TAPTITE,SI- | S.N.A  |
| ...4     | RFZ51    | 2008-000261 R-FUSIBLE(S);150ohm,5%,1W,AF,TP,3.9x10mm |        | ...4     | CIS         | 0205-000129 GREASE-SILICON;SC102,JAPAN               | S.N.A  |
| ...4     | RFZ52    | 2008-000261 R-FUSIBLE(S);150ohm,5%,1W,AF,TP,3.9x10mm |        | ...4     | CIS         | 6003-000334 SCREW-TAPTITE;RH,+2S,M3,L6,ZPC(YEL),SWR  | S.N.A  |
| ...4     | RFZ53    | 2008-000261 R-FUSIBLE(S);150ohm,5%,1W,AF,TP,3.9x10mm |        | ...4     | CIS         | AA62-00045B HEAT SINK;COMMANDO,AL1050,T1.0,H45.0     | S.N.A  |
| ...4     | RZ104    | 2001-001114 R-CARBON(S);270OHM,5%,1/2W,AA,TP,2.4X6.4 |        | ...4     | CIS         | 1203-000203 IC-POS.ADJUST REG.;3050,T0-220,5P,-,PLA  |        |
| ...4     | RZ105    | 2001-001114 R-CARBON(S);270OHM,5%,1/2W,AA,TP,2.4X6.4 |        | ..3      | JA701       | 3722-001426 JACK-PIN,9P,3.4mm,NI,BLK,-               |        |
| ...4     | RZ106    | 2001-001114 R-CARBON(S);270OHM,5%,1/2W,AA,TP,2.4X6.4 |        | ..3      | JA702       | 3722-001871 JACK-PIN;5P(9P),8.3MM,NI,GRN/BLU/RED/WHT |        |
| ...4     | RZ107    | 2001-001114 R-CARBON(S);270OHM,5%,1/2W,AA,TP,2.4X6.4 |        | ..3      | JA703       | 3722-001163 JACK-VHS;4P,12mm,AU,BLK,N                |        |
| ...4     | RZ108    | 2001-001114 R-CARBON(S);270OHM,5%,1/2W,AA,TP,2.4X6.4 |        | ..3      | JA704       | 3722-001795 JACK-PIN;10P(10P),-NI,RD/WH/RD/BL/GN*2,  |        |
| ...4     | RZ109    | 2001-001114 R-CARBON(S);270OHM,5%,1/2W,AA,TP,2.4X6.4 |        | ..3      | L801        | AA29-00004A FILTER-LINE NOISE;-20UH,3A,AC80-260V,TQ  |        |
| ...4     | RZ110    | 2001-000800 R-CARBON;5.1KOHM,5%,1/8W,AA,TP,1.8X3.2MM |        | ..3      | L802        | AA27-10001C COIL-CHOKE;-100uH,K,-,5.0A,ST,700UH,K/R  |        |
| ...4     | RZ111    | 2001-000563 R-CARBON;27KOHM,5%,1/8W,AA,TP,1.8X3.2MM  |        | ..3      | TU01        | AA59-00164A MODULE-RFLP;ITTER;-JUMX-NT-005,-,2IN/3O  |        |
| ...4     | RZ112    | 2001-000563 R-CARBON;27KOHM,5%,1/8W,AA,TP,1.8X3.2MM  |        | ..3      | 0202-001167 | SOLDER-CREAM;RX3603-2330HO,S45A,PASTE,SN             | S.N.A  |
| ...4     | RZ113    | 2001-000591 R-CARBON;3.3KOHM,5%,1/8W,AA,TP,1.8X3.2MM |        | ..3      | AA95-02039A | ASSY SUB-PCB,CONV M3D;COMMANDO,                      |        |
| ...4     | RZ114    | 2001-000857 R-CARBON;560OHM,5%,1/8W,AA,TP,1.8X3.2MM  |        | ...4     | CN01        | 3703-001124 CONNECTOR-DIN;32P2R,MALE,ANGLE,AUF       |        |
| ...4     | RZ115    | 2001-000591 R-CARBON;3.3KOHM,5%,1/8W,AA,TP,1.8X3.2MM |        | ...4     | CN04        | 3711-003601 CONNECTOR-HEADER;BOX,12P,1R,2.5mm,ANGLE, |        |
| ...4     | RZ116    | 2001-000857 R-CARBON;560OHM,5%,1/8W,AA,TP,1.8X3.2MM  |        | ...4     | 0202-000187 | SOLDER-WIRE FLUX;-RS60S,D1.2.63Sn/37Pb               | S.N.A  |
| ...4     | RZ117    | 2001-000591 R-CARBON;3.3KOHM,5%,1/8W,AA,TP,1.8X3.2MM |        | ...4     | 0202-001167 | SOLDER-CREAM;RX3603-2330HO,S45A,PASTE,SN             | S.N.A  |
| ...4     | RZ118    | 2001-000857 R-CARBON;560OHM,5%,1/8W,AA,TP,1.8X3.2MM  |        | ...4     | AA97-07269A | ASSY SMD;1 , , , ,                                   | S.N.A  |
| ...4     | RZ123    | 2003-002148 R-METAL OXIDE;3.9OHM,2%,2W,AF,TP,3.9X10M |        | ...5     | C01         | 2402-001042 C-AL,SMD;100uF,20%,16V,GP,TP,6.6x6.6x5.4 |        |
| ...4     | RZ124    | 2003-002148 R-METAL OXIDE;3.9OHM,2%,2W,AF,TP,3.9X10M |        | ...5     | C02         | 2203-000181 C-CERAMIC,CHIP;100nF,+80-20%,25V,Y5V,TP, |        |
| ...4     | RZ125    | 2003-002148 R-METAL OXIDE;3.9OHM,2%,2W,AF,TP,3.9X10M |        | ...5     | C03         | 2402-001042 C-AL,SMD;100uF,20%,16V,GP,TP,6.6x6.6x5.4 |        |
| ...4     | RZ126    | 2003-002148 R-METAL OXIDE;3.9OHM,2%,2W,AF,TP,3.9X10M |        | ...5     | C04         | 2203-000181 C-CERAMIC,CHIP;100nF,+80-20%,25V,Y5V,TP, |        |
| ...4     | RZ127    | 2003-002148 R-METAL OXIDE;3.9OHM,2%,2W,AF,TP,3.9X10M |        | ...5     | C05         | 2203-000181 C-CERAMIC,CHIP;100nF,+80-20%,25V,Y5V,TP, |        |
| ...4     | RZ128    | 2003-002148 R-METAL OXIDE;3.9OHM,2%,2W,AF,TP,3.9X10M |        | ...5     | C06         | 2402-001042 C-AL,SMD;100uF,20%,16V,GP,TP,6.6x6.6x5.4 |        |
| ...4     | RZ129    | 2003-002171 R-METAL OXIDE(S);150ohm,5%,2W,AG,TP,3.9x |        | ...5     | C07         | 2203-000181 C-CERAMIC,CHIP;100nF,+80-20%,25V,Y5V,TP, |        |
| ...4     | RZ129A   | 2003-002171 R-METAL OXIDE(S);150ohm,5%,2W,AG,TP,3.9x |        | ...5     | C08         | 2203-000181 C-CERAMIC,CHIP;100nF,+80-20%,25V,Y5V,TP, |        |
| ...4     | RZ130    | 2003-002171 R-METAL OXIDE(S);150ohm,5%,2W,AG,TP,3.9x |        | ...5     | C09         | 2203-000181 C-CERAMIC,CHIP;100nF,+80-20%,25V,Y5V,TP, |        |
| ...4     | RZ130A   | 2003-002171 R-METAL OXIDE(S);150ohm,5%,2W,AG,TP,3.9x |        | ...5     | C10         | 2203-000181 C-CERAMIC,CHIP;100nF,+80-20%,25V,Y5V,TP, |        |
| ...4     | RZ131    | 2003-002171 R-METAL OXIDE(S);150ohm,5%,2W,AG,TP,3.9x |        | ...5     | C11         | 2203-000181 C-CERAMIC,CHIP;100nF,+80-20%,25V,Y5V,TP, |        |
| ...4     | RZ131A   | 2003-002171 R-METAL OXIDE(S);150ohm,5%,2W,AG,TP,3.9x |        | ...5     | C12         | 2203-000181 C-CERAMIC,CHIP;100nF,+80-20%,25V,Y5V,TP, |        |

Electrical Parts List

| Loc. No. | Code No. | Description ; Specification | Remark                                   | Loc. No. | Code No. | Description ; Specification | Remark  |
|----------|----------|-----------------------------|--|----------|----------|-----------------------------|---|
| .....5   | C13      | 2203-000181                 | C-CERAMIC,CHIP;100nF,+80-20%,25V,Y5V,TP, | .....5   | D04      | 0401-000160                 | DIODE-SWITCHING;ISS314,30V,100mA,USC,TP       |
| .....5   | C14      | 2402-001042                 | C-AL,SMD;100uF,20%,16V,GP,TP,6.6x6.6x5.4 | .....5   | D05      | 0401-000160                 | DIODE-SWITCHING;ISS314,30V,100mA,USC,TP       |
| .....5   | C15      | 2203-000181                 | C-CERAMIC,CHIP;100nF,+80-20%,25V,Y5V,TP, | .....5   | D06      | 0401-000160                 | DIODE-SWITCHING;ISS314,30V,100mA,USC,TP       |
| .....5   | C20      | 2203-000181                 | C-CERAMIC,CHIP;100nF,+80-20%,25V,Y5V,TP, | .....5   | DZ01     | 0403-001016                 | DIODE-ZENER;RLZ6.2B,6.2V,5.96-6.27V,400m      |
| .....5   | C21      | 2203-000181                 | C-CERAMIC,CHIP;100nF,+80-20%,25V,Y5V,TP, | .....5   | DZ02     | 0403-001016                 | DIODE-ZENER;RLZ6.2B,6.2V,5.96-6.27V,400m      |
| .....5   | C22      | 2203-000181                 | C-CERAMIC,CHIP;100nF,+80-20%,25V,Y5V,TP, | .....5   | DZ03     | 0403-001016                 | DIODE-ZENER;RLZ6.2B,6.2V,5.96-6.27V,400m      |
| .....5   | C23      | 2203-000181                 | C-CERAMIC,CHIP;100nF,+80-20%,25V,Y5V,TP, | .....5   | EF01     | 2901-000229                 | FILTER-EMI SMD;50V,0.3A,-,22000pF,4.5x3.      |
| .....5   | C24      | 2203-000181                 | C-CERAMIC,CHIP;100nF,+80-20%,25V,Y5V,TP, | .....5   | EF02     | 2901-000229                 | FILTER-EMI SMD;50V,0.3A,-,22000pF,4.5x3.      |
| .....5   | C25      | 2203-000181                 | C-CERAMIC,CHIP;100nF,+80-20%,25V,Y5V,TP, | .....5   | EF03     | 3301-001324                 | CORE-FERRITE BEAD;AB,150HM,2X1.25X0.9MM,      |
| .....5   | C26      | 2203-000181                 | C-CERAMIC,CHIP;100nF,+80-20%,25V,Y5V,TP, | .....5   | EF04     | 3301-001324                 | CORE-FERRITE BEAD;AB,150HM,2X1.25X0.9MM,      |
| .....5   | C27      | 2203-000181                 | C-CERAMIC,CHIP;100nF,+80-20%,25V,Y5V,TP, | .....5   | EF05     | 2901-000226                 | FILTER-EMI SMD;25V,0.3A,-,100pF,3.2x1.25      |
| .....5   | C28      | 2203-000181                 | C-CERAMIC,CHIP;100nF,+80-20%,25V,Y5V,TP, | .....5   | EF06     | 2901-000226                 | FILTER-EMI SMD;25V,0.3A,-,100pF,3.2x1.25      |
| .....5   | C29      | 2203-000181                 | C-CERAMIC,CHIP;100nF,+80-20%,25V,Y5V,TP, | .....5   | EF07     | 3301-001324                 | CORE-FERRITE BEAD;AB,150HM,2X1.25X0.9MM,      |
| .....5   | C30      | 2203-000181                 | C-CERAMIC,CHIP;100nF,+80-20%,25V,Y5V,TP, | .....5   | EF08     | 3301-001324                 | CORE-FERRITE BEAD;AB,150HM,2X1.25X0.9MM,      |
| .....5   | C31      | 2203-000181                 | C-CERAMIC,CHIP;100nF,+80-20%,25V,Y5V,TP, | .....5   | EF09     | 3301-001324                 | CORE-FERRITE BEAD;AB,150HM,2X1.25X0.9MM,      |
| .....5   | C32      | 2203-000181                 | C-CERAMIC,CHIP;100nF,+80-20%,25V,Y5V,TP, | .....5   | EF10     | 3301-001324                 | CORE-FERRITE BEAD;AB,150HM,2X1.25X0.9MM,      |
| .....5   | C33      | 2203-000181                 | C-CERAMIC,CHIP;100nF,+80-20%,25V,Y5V,TP, | .....5   | IC01     | BP13-00003A                 | IC ASIC;SDC12,128,-0.3 TO +3.8,0 TO 70,Q      |
| .....5   | C34      | 2203-000181                 | C-CERAMIC,CHIP;100nF,+80-20%,25V,Y5V,TP, | .....5   | IC02     | 1203-002302                 | IC-POS.FIXED REG.;78RM33D,D-PAK,3P,-,PL       |
| .....5   | C35      | 2203-000181                 | C-CERAMIC,CHIP;100nF,+80-20%,25V,Y5V,TP, | .....5   | IC03     | 1203-001824                 | IC-VOL. DETECTOR;7042,SOT-89,3P,-,PLASTI      |
| .....5   | C36      | 2203-000181                 | C-CERAMIC,CHIP;100nF,+80-20%,25V,Y5V,TP, | .....5   | IC04     | 0801-002345                 | IC-CMOS LOGIC;7S04,INVERTER,SOT-353,5P,4      |
| .....5   | C37      | 2203-000181                 | C-CERAMIC,CHIP;100nF,+80-20%,25V,Y5V,TP, | .....5   | IC05     | 1103-001195                 | IC-EEPROM;24C64,8Kx8Bit,SOP,8P,150MIL,10      |
| .....5   | C38      | 2402-001042                 | C-AL,SMD;100uF,20%,16V,GP,TP,6.6x6.6x5.4 | .....5   | IC06     | AA09-00032A                 | IC-MCU;TSC87251G2D-0TP,4.5 TO 5.5V,-,32       |
| .....5   | C39      | 2203-000181                 | C-CERAMIC,CHIP;100nF,+80-20%,25V,Y5V,TP, | .....5   | IC07     | 1201-001520                 | IC-VIDEO AMP;EL2250CS,SOIC,8P,150MIL,DUA      |
| .....5   | C40      | 2402-001042                 | C-AL,SMD;100uF,20%,16V,GP,TP,6.6x6.6x5.4 | .....5   | IC08     | 1001-000164                 | IC-ANALOG MULTIPLEX;74HC4052,CMOS,SOP,16      |
| .....5   | C41      | 2203-000181                 | C-CERAMIC,CHIP;100nF,+80-20%,25V,Y5V,TP, | .....5   | IC09     | 1201-001504                 | IC-OP AMP;072,SOP,8P,150MIL,DUAL,-,PLAST      |
| .....5   | C42      | 2203-000357                 | C-CERAMIC,CHIP;0.15nF,5%,50V,NPO,TP,1608 | .....5   | IC10     | 1201-001504                 | IC-OP AMP;072,SOP,8P,150MIL,DUAL,-,PLAST      |
| .....5   | C43      | 2203-001071                 | C-CERAMIC,CHIP;0.056nF,5%,50V,NPO,TP,160 | .....5   | IC11     | 1201-001504                 | IC-OP AMP;072,SOP,8P,150MIL,DUAL,-,PLAST      |
| .....5   | C44      | 2203-000041                 | C-CERAMIC,CHIP;0.01nF,0.25pF,50V,NPO,TP, | .....5   | IC12     | 1201-001135                 | IC-OP AMP;324,SOP,ST,14P,150MIL,QUAD,100      |
| .....5   | C45      | 2203-000181                 | C-CERAMIC,CHIP;100nF,+80-20%,25V,Y5V,TP, | .....5   | IC13     | 1001-001155                 | IC-ANALOG MULTIPLEX;NC7S81357P6X,CMOS,SC      |
| .....5   | C46      | 2203-000357                 | C-CERAMIC,CHIP;0.15nF,5%,50V,NPO,TP,1608 | .....5   | IC14     | 1201-001504                 | IC-OP AMP;072,SOP,8P,150MIL,DUAL,-,PLAST      |
| .....5   | C47      | 2203-001071                 | C-CERAMIC,CHIP;0.056nF,5%,50V,NPO,TP,160 | .....5   | IC15     | 0801-002345                 | IC-CMOS LOGIC;7S04,INVERTER,SOT-353,5P,4      |
| .....5   | C48      | 2203-000041                 | C-CERAMIC,CHIP;0.01nF,0.25pF,50V,NPO,TP, | .....5   | IC16     | 0801-002345                 | IC-CMOS LOGIC;7S04,INVERTER,SOT-353,5P,4      |
| .....5   | C49      | 2203-000181                 | C-CERAMIC,CHIP;100nF,+80-20%,25V,Y5V,TP, | .....5   | IC17     | 1209-001163                 | IC-PLL;TLCC2932IPWLE,SOP,14P,-,PLASTIC        |
| .....5   | C50      | 2203-000357                 | C-CERAMIC,CHIP;0.15nF,5%,50V,NPO,TP,1608 | .....5   | L01      | 2701-001030                 | INDUCTOR-AXIAL;43uH,10%,5x14mm                |
| .....5   | C51      | 2203-001071                 | C-CERAMIC,CHIP;0.056nF,5%,50V,NPO,TP,160 | .....5   | OSC01    | 2804-001479                 | OSCILLATOR-CLOCK;24MHz,100PPM,50PF,TP,5V      |
| .....5   | C52      | 2203-000041                 | C-CERAMIC,CHIP;0.01nF,0.25pF,50V,NPO,TP, | .....5   | PCB      | AA41-00717A                 | PCB-CONVERGENCE MODULE;HCM4215W,FR-4,4L,S,N.A |
| .....5   | C53      | 2203-000181                 | C-CERAMIC,CHIP;100nF,+80-20%,25V,Y5V,TP, | .....5   | Q02      | 0501-000280                 | TR-SMALL SIGNAL;KSA1182,PNP,150mW,SOT-23      |
| .....5   | C54      | 2203-000181                 | C-CERAMIC,CHIP;100nF,+80-20%,25V,Y5V,TP, | .....5   | Q03      | 0501-000280                 | TR-SMALL SIGNAL;KSA1182,PNP,150mW,SOT-23      |
| .....5   | C55      | 2203-000357                 | C-CERAMIC,CHIP;0.15nF,5%,50V,NPO,TP,1608 | .....5   | Q04      | 0501-000342                 | TR-SMALL SIGNAL;KSC1623-Y,NPN,200mW,SOT-      |
| .....5   | C56      | 2203-001071                 | C-CERAMIC,CHIP;0.056nF,5%,50V,NPO,TP,160 | .....5   | Q07      | 0505-000110                 | FET-SILICON;2N7002,N,60V,115MA,7.50HM,0.      |
| .....5   | C57      | 2203-000041                 | C-CERAMIC,CHIP;0.01nF,0.25pF,50V,NPO,TP, | .....5   | Q08      | 0505-000110                 | FET-SILICON;2N7002,N,60V,115MA,7.50HM,0.      |
| .....5   | C58      | 2203-000181                 | C-CERAMIC,CHIP;100nF,+80-20%,25V,Y5V,TP, | .....5   | Q09      | 0505-000110                 | FET-SILICON;2N7002,N,60V,115MA,7.50HM,0.      |
| .....5   | C59      | 2203-000357                 | C-CERAMIC,CHIP;0.15nF,5%,50V,NPO,TP,1608 | .....5   | Q10      | 0501-000342                 | TR-SMALL SIGNAL;KSC1623-Y,NPN,200mW,SOT-      |
| .....5   | C60      | 2203-001071                 | C-CERAMIC,CHIP;0.056nF,5%,50V,NPO,TP,160 | .....5   | R01      | 2007-000084                 | R-CHIP;4.7Kohm,5%,1/16W,DA,TP,1608            |
| .....5   | C61      | 2203-000041                 | C-CERAMIC,CHIP;0.01nF,0.25pF,50V,NPO,TP, | .....5   | R02      | 2007-000074                 | R-CHIP;100ohm,5%,1/16W,DA,TP,1608             |
| .....5   | C62      | 2203-000181                 | C-CERAMIC,CHIP;100nF,+80-20%,25V,Y5V,TP, | .....5   | R03      | 2007-000078                 | R-CHIP;1Kohm,5%,1/16W,DA,TP,1608              |
| .....5   | C63      | 2203-000357                 | C-CERAMIC,CHIP;0.15nF,5%,50V,NPO,TP,1608 | .....5   | R04      | 2007-000084                 | R-CHIP;4.7Kohm,5%,1/16W,DA,TP,1608            |
| .....5   | C64      | 2203-001071                 | C-CERAMIC,CHIP;0.056nF,5%,50V,NPO,TP,160 | .....5   | R05      | 2007-000102                 | R-CHIP;100Kohm,5%,1/16W,DA,TP,1608            |
| .....5   | C65      | 2203-000041                 | C-CERAMIC,CHIP;0.01nF,0.25pF,50V,NPO,TP, | .....5   | R06      | 2007-000084                 | R-CHIP;4.7Kohm,5%,1/16W,DA,TP,1608            |
| .....5   | C66      | 2203-001083                 | C-CERAMIC,CHIP;0.005nF,0.1pF,50V,NPO,TP, | .....5   | R07      | 2007-000084                 | R-CHIP;4.7Kohm,5%,1/16W,DA,TP,1608            |
| .....5   | C67      | 2203-001083                 | C-CERAMIC,CHIP;0.005nF,0.1pF,50V,NPO,TP, | .....5   | R08      | 2007-000084                 | R-CHIP;4.7Kohm,5%,1/16W,DA,TP,1608            |
| .....5   | C68      | 2203-001083                 | C-CERAMIC,CHIP;0.005nF,0.1pF,50V,NPO,TP, | .....5   | R09      | 2007-000072                 | R-CHIP;47ohm,5%,1/16W,DA,TP,1608              |
| .....5   | C69      | 2203-001083                 | C-CERAMIC,CHIP;0.005nF,0.1pF,50V,NPO,TP, | .....5   | R10      | 2007-000072                 | R-CHIP;47ohm,5%,1/16W,DA,TP,1608              |
| .....5   | C70      | 2402-001042                 | C-AL,SMD;100uF,20%,16V,GP,TP,6.6x6.6x5.4 | .....5   | R100     | 2007-000125                 | R-CHIP;3.9Kohm,5%,1/16W,DA,TP,1608            |
| .....5   | C71      | 2203-000181                 | C-CERAMIC,CHIP;100nF,+80-20%,25V,Y5V,TP, | .....5   | R101     | 2007-000090                 | R-CHIP;10KOHM,5%,1/16W,DA,TP,1608             |
| .....5   | C72      | 2203-000257                 | C-CERAMIC,CHIP;10nF,10%,50V,X7R,TP,1608  | .....5   | R107     | 2007-000122                 | R-CHIP;1.2Kohm,5%,1/16W,DA,TP,1608            |
| .....5   | C73      | 2203-000975                 | C-CERAMIC,CHIP;47nF,10%,25V,X7R,TP,1608, | .....5   | R108     | 2007-000381                 | R-CHIP;13Kohm,5%,1/16W,DA,TP,1608             |
| .....5   | C74      | 2203-000975                 | C-CERAMIC,CHIP;47nF,10%,25V,X7R,TP,1608, | .....5   | R109     | 2007-000082                 | R-CHIP;3.3Kohm,5%,1/16W,DA,TP,1608            |
| .....5   | C75      | 2203-000257                 | C-CERAMIC,CHIP;10nF,10%,50V,X7R,TP,1608  | .....5   | R11      | 2007-000078                 | R-CHIP;1Kohm,5%,1/16W,DA,TP,1608              |
| .....5   | C77      | 2203-000440                 | C-CERAMIC,CHIP;1nF,10%,50V,X7R,TP,1608,- | .....5   | R110     | 2007-000078                 | R-CHIP;1Kohm,5%,1/16W,DA,TP,1608              |
| .....5   | C78      | 2203-000181                 | C-CERAMIC,CHIP;100nF,+80-20%,25V,Y5V,TP, | .....5   | R113     | 2007-000090                 | R-CHIP;10KOHM,5%,1/16W,DA,TP,1608             |
| .....5   | C79      | 2203-000181                 | C-CERAMIC,CHIP;100nF,+80-20%,25V,Y5V,TP, | .....5   | R114     | 2007-000090                 | R-CHIP;10KOHM,5%,1/16W,DA,TP,1608             |
| .....5   | C80      | 2402-001049                 | C-AL,CHIP;10uF,20%,16V,GP,TP,3.3x3.3x5.4 | .....5   | R115     | 2007-000090                 | R-CHIP;10KOHM,5%,1/16W,DA,TP,1608             |
| .....5   | C81      | 2203-000041                 | C-CERAMIC,CHIP;0.01nF,0.25pF,50V,NPO,TP, | .....5   | R116     | 2007-001179                 | R-CHIP;8.2Kohm,5%,1/16W,DA,TP,1608            |
| .....5   | C82      | 2203-001071                 | C-CERAMIC,CHIP;0.056nF,5%,50V,NPO,TP,160 | .....5   | R117     | 2007-000122                 | R-CHIP;1.2Kohm,5%,1/16W,DA,TP,1608            |
| .....5   | C83      | 2203-000181                 | C-CERAMIC,CHIP;100nF,+80-20%,25V,Y5V,TP, | .....5   | R118     | 2007-000084                 | R-CHIP;4.7Kohm,5%,1/16W,DA,TP,1608            |
| .....5   | C84      | 2402-001042                 | C-AL,SMD;100uF,20%,16V,GP,TP,6.6x6.6x5.4 | .....5   | R119     | 2007-000084                 | R-CHIP;4.7Kohm,5%,1/16W,DA,TP,1608            |
| .....5   | C85      | 2203-000181                 | C-CERAMIC,CHIP;100nF,+80-20%,25V,Y5V,TP, | .....5   | R120     | 2007-000124                 | R-CHIP;2.2Kohm,5%,1/16W,DA,TP,1608            |
| .....5   | C86      | 2203-000181                 | C-CERAMIC,CHIP;100nF,+80-20%,25V,Y5V,TP, | .....5   | R121     | 2007-000084                 | R-CHIP;4.7Kohm,5%,1/16W,DA,TP,1608            |
| .....5   | C87      | 2203-001245                 | C-CERAMIC,CHIP;0.082nF,5%,50V,NPO,TP,201 | .....5   | R122     | 2007-000070                 | R-CHIP;0ohm,5%,1/16W,DA,TP,1608               |
| .....5   | C88      | 2203-000975                 | C-CERAMIC,CHIP;47nF,10%,25V,X7R,TP,1608, | .....5   | R123     | 2007-000070                 | R-CHIP;0ohm,5%,1/16W,DA,TP,1608               |
| .....5   | C89      | 2203-000257                 | C-CERAMIC,CHIP;10nF,10%,50V,X7R,TP,1608  | .....5   | R125     | 2007-000355                 | R-CHIP;12KOHM,5%,1/10W,DA,TP,2012             |
| .....5   | C90      | 2203-000575                 | C-CERAMIC,CHIP;220NF,10%,25V,X7R,TP,2012 | .....5   | R126     | 2007-000856                 | R-CHIP;4.3KOHM,1%,1/10W,DA,TP,2012            |
| .....5   | C91      | 2203-000575                 | C-CERAMIC,CHIP;220NF,10%,25V,X7R,TP,2012 | .....5   | R127     | 2007-000109                 | R-CHIP;1Mohm,5%,1/16W,DA,TP,1608              |
| .....5   | D01      | 0401-000160                 | DIODE-SWITCHING;ISS314,30V,100mA,USC,TP  | .....5   | R128     | 2007-000123                 | R-CHIP;1.5Kohm,5%,1/16W,DA,TP,1608            |
| .....5   | D02      | 0401-000160                 | DIODE-SWITCHING;ISS314,30V,100mA,USC,TP  | .....5   | R129     | 2007-000072                 | R-CHIP;47ohm,5%,1/16W,DA,TP,1608              |
| .....5   | D03      | 0401-000160                 | DIODE-SWITCHING;ISS314,30V,100mA,USC,TP  | .....5   | R133     | 2007-000084                 | R-CHIP;4.7Kohm,5%,1/16W,DA,TP,1608            |

| Loc. No. | Code No. | Description ; Specification | Remark                             | Loc. No. | Code No. | Description ; Specification | Remark   |
|----------|----------|-----------------------------|------------------------------------|----------|----------|-----------------------------|--|
| .....    | R134     | 2007-000072                 | R-CHIP;47ohm,5%,1/16W,DA,TP,1608   | .....    | R95      | 2007-000704                 | R-CHIP;3.6Kohm,5%,1/16W,DA,TP,1608                   |
| .....    | R135     | 2007-000072                 | R-CHIP;47ohm,5%,1/16W,DA,TP,1608   | .....    | R96      | 2007-000090                 | R-CHIP;10KOHM,5%,1/16W,DA,TP,1608                    |
| .....    | R136     | 2007-000072                 | R-CHIP;47ohm,5%,1/16W,DA,TP,1608   | .....    | R97      | 2007-000090                 | R-CHIP;10KOHM,5%,1/16W,DA,TP,1608                    |
| .....    | R137     | 2007-000402                 | R-CHIP;150ohm,5%,1/16W,DA,TP,1608  | .....    | R98      | 2007-000078                 | R-CHIP;1Kohm,5%,1/16W,DA,TP,1608                     |
| .....    | R138     | 2007-000402                 | R-CHIP;150ohm,5%,1/16W,DA,TP,1608  | .....    | R99      | 2007-000704                 | R-CHIP;3.6Kohm,5%,1/16W,DA,TP,1608                   |
| .....    | R139     | 2007-000402                 | R-CHIP;150ohm,5%,1/16W,DA,TP,1608  | .....    | RN01     | 2011-000585                 | R-NETWORK;47ohm,5%,63mW,L,CHIP,8P,TP                 |
| .....    | R15      | 2007-000072                 | R-CHIP;47ohm,5%,1/16W,DA,TP,1608   | .....    | RN02     | 2011-000585                 | R-NETWORK;47ohm,5%,63mW,L,CHIP,8P,TP                 |
| .....    | R16      | 2007-000074                 | R-CHIP;100ohm,5%,1/16W,DA,TP,1608  | .....    | RN03     | 2011-000585                 | R-NETWORK;47ohm,5%,63mW,L,CHIP,8P,TP                 |
| .....    | R17      | 2007-000074                 | R-CHIP;100ohm,5%,1/16W,DA,TP,1608  | .....    | RN04     | 2011-000585                 | R-NETWORK;47ohm,5%,63mW,L,CHIP,8P,TP                 |
| .....    | R20      | 2007-000074                 | R-CHIP;100ohm,5%,1/16W,DA,TP,1608  | .....    | RN05     | 2011-000585                 | R-NETWORK;47ohm,5%,63mW,L,CHIP,8P,TP                 |
| .....    | R24      | 2007-000072                 | R-CHIP;47ohm,5%,1/16W,DA,TP,1608   | .....    | RN06     | 2011-000585                 | R-NETWORK;47ohm,5%,63mW,L,CHIP,8P,TP                 |
| .....    | R25      | 2007-000070                 | R-CHIP;0ohm,5%,1/16W,DA,TP,1608    | .....    | 3        | AA95-02001K                 | ASSY SUB-PCB MICOM; C2                               |
| .....    | R26      | 2007-001167                 | R-CHIP;75ohm,5%,1/16W,DA,TP,1608   | .....    | 4        | CN901                       | 3703-001175 CONNECTOR-DIN;64P,2R,MALE,ANGLE,AU       |
| .....    | R27      | 2007-001167                 | R-CHIP;75ohm,5%,1/16W,DA,TP,1608   | .....    | 4        | D907                        | 0402-000274 DIODE-RECTIFIER;UF4004,400V,1A,DO-41,TP  |
| .....    | R28      | 2007-000122                 | R-CHIP;1.2Kohm,5%,1/16W,DA,TP,1608 | .....    | 4        | IC904                       | 1203-001943 IC-VOL. DETECTOR;7025,TO-92,3P,-,PLASTIC |
| .....    | R29      | 2007-000122                 | R-CHIP;1.2Kohm,5%,1/16W,DA,TP,1608 | .....    | 4        | IC905                       | 1102-001130 IC-EPROM;M27W201-80F6,256KX8BIT,DIP;32P, |
| .....    | R30      | 2007-000028                 | R-CHIP;390OHM,5%,1/10W,DA,TP,2012  | .....    | 4        | Q901                        | 0505-000109 FET-SILICON;2N7000,N,60V,200mA,5ohm,400m |
| .....    | R31      | 2007-000028                 | R-CHIP;390OHM,5%,1/10W,DA,TP,2012  | .....    | 4        | Q903                        | 0505-000109 FET-SILICON;2N7000,N,60V,200mA,5ohm,400m |
| .....    | R32      | 2007-000119                 | R-CHIP;560ohm,5%,1/16W,DA,TP,1608  | .....    | 4        | X901                        | 2801-004071 CRYSTAL-UNIT;6MHZ,30PPM,28-AAM,20PF,400H |
| .....    | R33      | 2007-000124                 | R-CHIP;2.2Kohm,5%,1/16W,DA,TP,1608 | .....    | 4        | .....                       | SOLDER-CREAM;RX3603-2330HO,S45A,PASTE,SN S.N.A       |
| .....    | R34      | 2007-000122                 | R-CHIP;1.2Kohm,5%,1/16W,DA,TP,1608 | .....    | 4        | .....                       | SOLDER-WIRE FLUX;-RS60S,D1.2.63Sn/37Pb S.N.A         |
| .....    | R35      | 2007-000028                 | R-CHIP;390OHM,5%,1/10W,DA,TP,2012  | .....    | 4        | .....                       | AA97-07275A ASSY SMD; 1 , , , , S.N.A                |
| .....    | R36      | 2007-000028                 | R-CHIP;390OHM,5%,1/10W,DA,TP,2012  | .....    | .....    | C901                        | 2203-000748 C-CERAMIC,CHIP;0.03nF,5%,50V,NPO,TP,2012 |
| .....    | R37      | 2007-000078                 | R-CHIP;1Kohm,5%,1/16W,DA,TP,1608   | .....    | .....    | C902                        | 2203-000440 C-CERAMIC,CHIP;1nF,10%,50V,X7R,TP,1608,- |
| .....    | R38      | 2007-000078                 | R-CHIP;1Kohm,5%,1/16W,DA,TP,1608   | .....    | .....    | C903                        | 2203-000357 C-CERAMIC,CHIP;0.15nF,5%,50V,NPO,TP,1608 |
| .....    | R39      | 2007-000078                 | R-CHIP;1Kohm,5%,1/16W,DA,TP,1608   | .....    | .....    | C904                        | 2203-000440 C-CERAMIC,CHIP;1nF,10%,50V,X7R,TP,1608,- |
| .....    | R40      | 2007-000078                 | R-CHIP;1Kohm,5%,1/16W,DA,TP,1608   | .....    | .....    | C905                        | 2203-000444 C-CERAMIC,CHIP;1nF,10%,50V,X7R,TP,2012,- |
| .....    | R41      | 2007-000078                 | R-CHIP;1Kohm,5%,1/16W,DA,TP,1608   | .....    | .....    | C906                        | 2203-000440 C-CERAMIC,CHIP;1nF,10%,50V,X7R,TP,1608,- |
| .....    | R42      | 2007-000078                 | R-CHIP;1Kohm,5%,1/16W,DA,TP,1608   | .....    | .....    | C907                        | 2203-000181 C-CERAMIC,CHIP;100nF,+80-20%,25V,Y5V,TP, |
| .....    | R43      | 2007-000078                 | R-CHIP;1Kohm,5%,1/16W,DA,TP,1608   | .....    | .....    | C908                        | 2203-001048 C-CERAMIC,CHIP;0.56nF,10%,50V,NPO,TP,201 |
| .....    | R44      | 2007-000078                 | R-CHIP;1Kohm,5%,1/16W,DA,TP,1608   | .....    | .....    | C909                        | 2203-000260 C-CERAMIC,CHIP;10nF,10%,50V,X7R,TP,2012  |
| .....    | R45      | 2007-000072                 | R-CHIP;47ohm,5%,1/16W,DA,TP,1608   | .....    | .....    | C910                        | 2203-000748 C-CERAMIC,CHIP;0.03nF,5%,50V,NPO,TP,2012 |
| .....    | R46      | 2007-000072                 | R-CHIP;47ohm,5%,1/16W,DA,TP,1608   | .....    | .....    | C911                        | 2402-001049 C-AL,CHIP;10uF,20%,16V,GP,TP,3.3x3.3x5.4 |
| .....    | R47      | 2007-000074                 | R-CHIP;100ohm,5%,1/16W,DA,TP,1608  | .....    | .....    | C912                        | 2402-001049 C-AL,CHIP;10uF,20%,16V,GP,TP,3.3x3.3x5.4 |
| .....    | R48      | 2007-000084                 | R-CHIP;4.7Kohm,5%,1/16W,DA,TP,1608 | .....    | .....    | C913                        | 2402-001042 C-AL,SMD;100uF,20%,16V,GP,TP,6.6x6.6x5.4 |
| .....    | R49      | 2007-000084                 | R-CHIP;4.7Kohm,5%,1/16W,DA,TP,1608 | .....    | .....    | C914                        | 2203-000181 C-CERAMIC,CHIP;100nF,+80-20%,25V,Y5V,TP, |
| .....    | R50      | 2007-000078                 | R-CHIP;1Kohm,5%,1/16W,DA,TP,1608   | .....    | .....    | C915                        | 2402-001042 C-AL,SMD;100uF,20%,16V,GP,TP,6.6x6.6x5.4 |
| .....    | R51      | 2007-000080                 | R-CHIP;2Kohm,5%,1/16W,DA,TP,1608   | .....    | .....    | C916                        | 2203-000181 C-CERAMIC,CHIP;100nF,+80-20%,25V,Y5V,TP, |
| .....    | R52      | 2007-000078                 | R-CHIP;1Kohm,5%,1/16W,DA,TP,1608   | .....    | .....    | C917                        | 2402-001049 C-AL,CHIP;10uF,20%,16V,GP,TP,3.3x3.3x5.4 |
| .....    | R53      | 2007-000074                 | R-CHIP;100ohm,5%,1/16W,DA,TP,1608  | .....    | .....    | C918                        | 2402-001042 C-AL,SMD;100uF,20%,16V,GP,TP,6.6x6.6x5.4 |
| .....    | R54      | 2007-000084                 | R-CHIP;4.7Kohm,5%,1/16W,DA,TP,1608 | .....    | .....    | C919                        | 2203-000181 C-CERAMIC,CHIP;100nF,+80-20%,25V,Y5V,TP, |
| .....    | R55      | 2007-000084                 | R-CHIP;4.7Kohm,5%,1/16W,DA,TP,1608 | .....    | .....    | C920                        | 2203-000181 C-CERAMIC,CHIP;100nF,+80-20%,25V,Y5V,TP, |
| .....    | R56      | 2007-000078                 | R-CHIP;1Kohm,5%,1/16W,DA,TP,1608   | .....    | .....    | C921                        | 2402-001042 C-AL,SMD;100uF,20%,16V,GP,TP,6.6x6.6x5.4 |
| .....    | R57      | 2007-000080                 | R-CHIP;2Kohm,5%,1/16W,DA,TP,1608   | .....    | .....    | C922                        | 2203-005809 C-CERAMIC,CHIP;1000nF,10%,16V,X7R,TP,201 |
| .....    | R58      | 2007-000078                 | R-CHIP;1Kohm,5%,1/16W,DA,TP,1608   | .....    | .....    | C924                        | 2203-000181 C-CERAMIC,CHIP;100nF,+80-20%,25V,Y5V,TP, |
| .....    | R59      | 2007-000074                 | R-CHIP;100ohm,5%,1/16W,DA,TP,1608  | .....    | .....    | C925                        | 2203-000181 C-CERAMIC,CHIP;100nF,+80-20%,25V,Y5V,TP, |
| .....    | R60      | 2007-000084                 | R-CHIP;4.7Kohm,5%,1/16W,DA,TP,1608 | .....    | .....    | C926                        | 2203-000181 C-CERAMIC,CHIP;100nF,+80-20%,25V,Y5V,TP, |
| .....    | R61      | 2007-000084                 | R-CHIP;4.7Kohm,5%,1/16W,DA,TP,1608 | .....    | .....    | C927                        | 2203-000181 C-CERAMIC,CHIP;100nF,+80-20%,25V,Y5V,TP, |
| .....    | R62      | 2007-000078                 | R-CHIP;1Kohm,5%,1/16W,DA,TP,1608   | .....    | .....    | C928                        | 2203-000181 C-CERAMIC,CHIP;100nF,+80-20%,25V,Y5V,TP, |
| .....    | R63      | 2007-000080                 | R-CHIP;2Kohm,5%,1/16W,DA,TP,1608   | .....    | .....    | C929                        | 2203-000181 C-CERAMIC,CHIP;100nF,+80-20%,25V,Y5V,TP, |
| .....    | R64      | 2007-000078                 | R-CHIP;1Kohm,5%,1/16W,DA,TP,1608   | .....    | .....    | C931                        | 2203-000189 C-CERAMIC,CHIP;100nF,+80-20%,25V,Y5V,TP, |
| .....    | R65      | 2007-000074                 | R-CHIP;100ohm,5%,1/16W,DA,TP,1608  | .....    | .....    | C932                        | 2203-000181 C-CERAMIC,CHIP;100nF,+80-20%,25V,Y5V,TP, |
| .....    | R66      | 2007-000084                 | R-CHIP;4.7Kohm,5%,1/16W,DA,TP,1608 | .....    | .....    | C933                        | 2203-000236 C-CERAMIC,CHIP;0.1nF,5%,50V,NPO,TP,1608  |
| .....    | R67      | 2007-000084                 | R-CHIP;4.7Kohm,5%,1/16W,DA,TP,1608 | .....    | .....    | C934                        | 2203-000236 C-CERAMIC,CHIP;0.1nF,5%,50V,NPO,TP,1608  |
| .....    | R68      | 2007-000078                 | R-CHIP;1Kohm,5%,1/16W,DA,TP,1608   | .....    | .....    | C935                        | 2203-000236 C-CERAMIC,CHIP;0.1nF,5%,50V,NPO,TP,1608  |
| .....    | R69      | 2007-000080                 | R-CHIP;2Kohm,5%,1/16W,DA,TP,1608   | .....    | .....    | C936                        | 2402-001042 C-AL,SMD;100uF,20%,16V,GP,TP,6.6x6.6x5.4 |
| .....    | R70      | 2007-000078                 | R-CHIP;1Kohm,5%,1/16W,DA,TP,1608   | .....    | .....    | C937                        | 2203-000236 C-CERAMIC,CHIP;0.1nF,5%,50V,NPO,TP,1608  |
| .....    | R71      | 2007-000074                 | R-CHIP;100ohm,5%,1/16W,DA,TP,1608  | .....    | .....    | C938                        | 2402-001042 C-AL,SMD;100uF,20%,16V,GP,TP,6.6x6.6x5.4 |
| .....    | R72      | 2007-000084                 | R-CHIP;4.7Kohm,5%,1/16W,DA,TP,1608 | .....    | .....    | C950                        | 2402-000179 C-AL,SMD;47uF,20%,16V,GP,TP,6.6x6.6x5.4  |
| .....    | R73      | 2007-000084                 | R-CHIP;4.7Kohm,5%,1/16W,DA,TP,1608 | .....    | .....    | C951                        | 2203-000221 C-CERAMIC,CHIP;100nF,20%,50V,Y5V,TP,3216 |
| .....    | R74      | 2007-000078                 | R-CHIP;1Kohm,5%,1/16W,DA,TP,1608   | .....    | .....    | D602                        | 0401-000133 DIODE-SWITCHING;RLS4148,100V,200MA,SOD-8 |
| .....    | R75      | 2007-000080                 | R-CHIP;2Kohm,5%,1/16W,DA,TP,1608   | .....    | .....    | D901                        | 0401-000133 DIODE-SWITCHING;RLS4148,100V,200MA,SOD-8 |
| .....    | R76      | 2007-000078                 | R-CHIP;1Kohm,5%,1/16W,DA,TP,1608   | .....    | .....    | D902                        | 0401-000133 DIODE-SWITCHING;RLS4148,100V,200MA,SOD-8 |
| .....    | R77      | 2007-000074                 | R-CHIP;100ohm,5%,1/16W,DA,TP,1608  | .....    | .....    | D905                        | 0401-000133 DIODE-SWITCHING;RLS4148,100V,200MA,SOD-8 |
| .....    | R78      | 2007-000084                 | R-CHIP;4.7Kohm,5%,1/16W,DA,TP,1608 | .....    | .....    | D906                        | 0401-000133 DIODE-SWITCHING;RLS4148,100V,200MA,SOD-8 |
| .....    | R79      | 2007-000084                 | R-CHIP;4.7Kohm,5%,1/16W,DA,TP,1608 | .....    | .....    | D920                        | 0401-000133 DIODE-SWITCHING;RLS4148,100V,200MA,SOD-8 |
| .....    | R80      | 2007-000078                 | R-CHIP;1Kohm,5%,1/16W,DA,TP,1608   | .....    | .....    | D923                        | 0401-000133 DIODE-SWITCHING;RLS4148,100V,200MA,SOD-8 |
| .....    | R81      | 2007-000080                 | R-CHIP;2Kohm,5%,1/16W,DA,TP,1608   | .....    | .....    | DZ904                       | 0403-001375 DIODE-ZENER;RLZ3.6B,3.6-3.845V,500mW,LL- |
| .....    | R82      | 2007-000078                 | R-CHIP;1Kohm,5%,1/16W,DA,TP,1608   | .....    | .....    | DZ905                       | 0403-001375 DIODE-ZENER;RLZ3.6B,3.6-3.845V,500mW,LL- |
| .....    | R87      | 2007-000757                 | R-CHIP;330KOHM,5%,1/10W,DA,TP,2012 | .....    | .....    | DZ906                       | 0403-001375 DIODE-ZENER;RLZ3.6B,3.6-3.845V,500mW,LL- |
| .....    | R88      | 2007-000757                 | R-CHIP;330KOHM,5%,1/10W,DA,TP,2012 | .....    | .....    | DZ907                       | 0403-001375 DIODE-ZENER;RLZ3.6B,3.6-3.845V,500mW,LL- |
| .....    | R89      | 2007-000757                 | R-CHIP;330KOHM,5%,1/10W,DA,TP,2012 | .....    | .....    | DZ918                       | 0403-001375 DIODE-ZENER;RLZ3.6B,3.6-3.845V,500mW,LL- |
| .....    | R90      | 2007-000757                 | R-CHIP;330KOHM,5%,1/10W,DA,TP,2012 | .....    | .....    | DZ919                       | 0403-001375 DIODE-ZENER;RLZ3.6B,3.6-3.845V,500mW,LL- |
| .....    | R91      | 2007-000074                 | R-CHIP;100ohm,5%,1/16W,DA,TP,1608  | .....    | .....    | DZ920                       | 0403-001375 DIODE-ZENER;RLZ3.6B,3.6-3.845V,500mW,LL- |
| .....    | R92      | 2007-000090                 | R-CHIP;10KOHM,5%,1/16W,DA,TP,1608  | .....    | .....    | IC901                       | 1204-000192 IC-DECODER;SDA5550M,P-MQFP,100P,-,PLASTI |
| .....    | R93      | 2007-000090                 | R-CHIP;10KOHM,5%,1/16W,DA,TP,1608  | .....    | .....    | IC902                       | 1103-000180 IC-EEPROM;24C16,2Kx8BIT,SOP,8P,150ML,10  |
| .....    | R94      | 2007-000078                 | R-CHIP;1Kohm,5%,1/16W,DA,TP,1608   | .....    | .....    | IC903                       | 1203-002302 IC-POSIFIXED REG.;78RM33D,D-PAK,3P,-,PL  |

| Loc. No. | Code No. | Description ; Specification                          | Remark | Loc. No. | Code No. | Description ; Specification                          | Remark |
|----------|----------|--|--------|----------|----------|--|--------|
| .....5   | R901     | 3301-001324 CORE-FERRITE BEAD;AB,150HM,2X1.25X0.9MM, |        | .....5   | R976     | 2007-000084 R-CHIP;4.7Kohm,5%,1/16W,DA,TP,1608       |        |
| .....5   | R902     | 3301-001324 CORE-FERRITE BEAD;AB,150HM,2X1.25X0.9MM, |        | .....5   | R978     | 2007-000084 R-CHIP;4.7Kohm,5%,1/16W,DA,TP,1608       |        |
| .....5   | R903     | 3301-001324 CORE-FERRITE BEAD;AB,150HM,2X1.25X0.9MM, |        | .....5   | R979     | 2007-000074 R-CHIP;100ohm,5%,1/16W,DA,TP,1608        |        |
| .....5   | R904     | 3301-001324 CORE-FERRITE BEAD;AB,150HM,2X1.25X0.9MM, |        | .....5   | R980     | 2007-000084 R-CHIP;4.7Kohm,5%,1/16W,DA,TP,1608       |        |
| .....5   | R905     | 2703-001245 INDUCTOR-SMD;8.2uH,10%,2x1.25x1.25mm     |        | .....5   | R981     | 2007-000070 R-CHIP;0ohm,5%,1/16W,DA,TP,1608          |        |
| .....5   | R907     | 3301-001324 CORE-FERRITE BEAD;AB,150HM,2X1.25X0.9MM, |        | .....5   | R982     | 2007-000084 R-CHIP;4.7Kohm,5%,1/16W,DA,TP,1608       |        |
| .....5   | R920     | 3301-001324 CORE-FERRITE BEAD;AB,150HM,2X1.25X0.9MM, |        | .....5   | R983     | 2007-000084 R-CHIP;4.7Kohm,5%,1/16W,DA,TP,1608       |        |
| .....5   | PCB      | AA41-00599A PCB-MICOM;FR-4,2LA,1.6T,180X245,COMMAN   | S.N.A  | .....5   | R985     | 2007-000084 R-CHIP;4.7Kohm,5%,1/16W,DA,TP,1608       |        |
| .....5   | Q902     | 0501-000344 TR-SMALL SIGNAL;KSC1623-G,NPN,200mW,SOT- |        | .....5   | R986     | 2007-000084 R-CHIP;4.7Kohm,5%,1/16W,DA,TP,1608       |        |
| .....5   | Q908     | 0501-000344 TR-SMALL SIGNAL;KSC1623-G,NPN,200mW,SOT- |        | .....5   | R987     | 2007-000090 R-CHIP;10KOHM,5%,1/16W,DA,TP,1608        |        |
| .....5   | Q910     | 0501-000344 TR-SMALL SIGNAL;KSC1623-G,NPN,200mW,SOT- |        | .....5   | R988     | 2007-000290 R-CHIP;1000HM,5%,1/10W,DA,TP,2012        |        |
| .....5   | Q913     | 0501-000344 TR-SMALL SIGNAL;KSC1623-G,NPN,200mW,SOT- |        | .....3   |          | AA65-30104C CLAMP-WIRE;ALL MODEL,NYLON 66,V2,-,NTR,W | S.N.A  |
| .....5   | Q914     | 0501-000344 TR-SMALL SIGNAL;KSC1623-G,NPN,200mW,SOT- |        | .....3   |          | BP39-00018A LEAD CONNECTOR;P55A/HCM4215W,UL2547#26,U |        |
| .....5   | Q915     | 0501-000344 TR-SMALL SIGNAL;KSC1623-G,NPN,200mW,SOT- |        | .....3   |          | BP95-00034A ASSY SUB-PRO SCAN;42W5,P55A,PRO-SCAN     |        |
| .....5   | Q916     | 0501-000344 TR-SMALL SIGNAL;KSC1623-G,NPN,200mW,SOT- |        | .....4   | CN01     | 3703-001124 CONNECTOR-DIN:32P,2R,MALE,ANGLE,AUF      |        |
| .....5   | Q917     | 0501-000344 TR-SMALL SIGNAL;KSC1623-G,NPN,200mW,SOT- |        | .....4   | CN02     | 3703-001124 CONNECTOR-DIN:32P,2R,MALE,ANGLE,AUF      |        |
| .....5   | Q920     | 0501-000344 TR-SMALL SIGNAL;KSC1623-G,NPN,200mW,SOT- |        | .....4   | CN03     | 3711-001164 CONNECTOR-HEADER;BOX,9P,1R,2.5mm,ANGLE,- |        |
| .....5   | R901     | 2007-000077 R-CHIP;470ohm,5%,1/16W,DA,TP,1608        |        | .....4   | CX01     | 2801-000199 CRYSTAL-UNIT;20MHz,50ppm,28-AAA,16pF,50o |        |
| .....5   | R903     | 2007-000084 R-CHIP;4.7Kohm,5%,1/16W,DA,TP,1608       |        | .....4   | EX01     | 2801-000419 CRYSTAL-UNIT;20.25MHz,30ppm,28-AAM,13pF, |        |
| .....5   | R904     | 2007-000084 R-CHIP;4.7Kohm,5%,1/16W,DA,TP,1608       |        | .....4   | FC58     | 2309-000138 C-FILM,PE-PPF;100nF,5%,50V,TP,20x16x8.5, |        |
| .....5   | R905     | 2007-000078 R-CHIP;1Kohm,5%,1/16W,DA,TP,1608         |        | .....4   | FC59     | 2305-000704 C-FILM,MPEF;100nF,5%,250V,TP,16.5x10.3x5 |        |
| .....5   | R906     | 2007-000084 R-CHIP;4.7Kohm,5%,1/16W,DA,TP,1608       |        | .....4   | FX01     | 2802-001177 RESONATOR-CERAMIC;2.696MHZ,0.4%,BK,10X4. |        |
| .....5   | R907     | 2007-000074 R-CHIP;100ohm,5%,1/16W,DA,TP,1608        |        | .....4   | SX01     | 2802-001179 RESONATOR-CERAMIC;4MHZ,0.5%,BK,8X3X5.5MM |        |
| .....5   | R908     | 2007-000084 R-CHIP;4.7Kohm,5%,1/16W,DA,TP,1608       |        | .....4   |          | BP97-00055A ASSY SMD;HCM2415,P55A,SMD-PRO-SCAN       |        |
| .....5   | R909     | 2007-000074 R-CHIP;100ohm,5%,1/16W,DA,TP,1608        |        | .....5   | CC01     | 2203-000626 C-CERAMIC,CHIP;0.022nF,5%,50V,NP0,TP,160 |        |
| .....5   | R911     | 2007-000076 R-CHIP;330ohm,5%,1/16W,DA,TP,1608        |        | .....5   | CC02     | 2402-000179 C-AL,SMD;47uF,20%,16V,GP,TP,6.6x6.6x5.4  |        |
| .....5   | R912     | 2007-000081 R-CHIP;2.7Kohm,5%,1/16W,DA,TP,1608       |        | .....5   | CC03     | 2203-000181 C-CERAMIC,CHIP;100nF,+80-20%,25V,Y5V,TP, |        |
| .....5   | R913     | 2007-000081 R-CHIP;2.7Kohm,5%,1/16W,DA,TP,1608       |        | .....5   | CC04     | 2203-000357 C-CERAMIC,CHIP;0.15nF,5%,50V,NP0,TP,1608 |        |
| .....5   | R914     | 2007-000123 R-CHIP;1.5Kohm,5%,1/16W,DA,TP,1608       |        | .....5   | CC11     | 2402-000179 C-AL,SMD;47uF,20%,16V,GP,TP,6.6x6.6x5.4  |        |
| .....5   | R915     | 2007-000081 R-CHIP;2.7Kohm,5%,1/16W,DA,TP,1608       |        | .....5   | CC12     | 2402-000170 C-AL,SMD;1uF,20%,50V,GP,TP,4.3x4.3x5.4,  |        |
| .....5   | R916     | 2007-000074 R-CHIP;100ohm,5%,1/16W,DA,TP,1608        |        | .....5   | CC13     | 2402-000179 C-AL,SMD;47uF,20%,16V,GP,TP,6.6x6.6x5.4  |        |
| .....5   | R917     | 2007-000074 R-CHIP;100ohm,5%,1/16W,DA,TP,1608        |        | .....5   | CC14     | 2203-000181 C-CERAMIC,CHIP;100nF,+80-20%,25V,Y5V,TP, |        |
| .....5   | R918     | 2007-000074 R-CHIP;100ohm,5%,1/16W,DA,TP,1608        |        | .....5   | CC15     | 2203-000181 C-CERAMIC,CHIP;100nF,+80-20%,25V,Y5V,TP, |        |
| .....5   | R921     | 2007-000078 R-CHIP;1Kohm,5%,1/16W,DA,TP,1608         |        | .....5   | CC16     | 2402-001049 C-AL,CHIP;10uF,20%,16V,GP,TP,3.3x3.3x5.4 |        |
| .....5   | R922     | 2007-000074 R-CHIP;100ohm,5%,1/16W,DA,TP,1608        |        | .....5   | CC17     | 2203-001034 C-CERAMIC,CHIP;5.6nF,10%,50V,X7R,TP,1608 |        |
| .....5   | R923     | 2007-000074 R-CHIP;100ohm,5%,1/16W,DA,TP,1608        |        | .....5   | CC18     | 2402-000170 C-AL,SMD;1uF,20%,50V,GP,TP,4.3x4.3x5.4,  |        |
| .....5   | R924     | 2007-000078 R-CHIP;1Kohm,5%,1/16W,DA,TP,1608         |        | .....5   | CC20     | 2203-000181 C-CERAMIC,CHIP;100nF,+80-20%,25V,Y5V,TP, |        |
| .....5   | R925     | 2007-000078 R-CHIP;1Kohm,5%,1/16W,DA,TP,1608         |        | .....5   | CC21     | 2203-000181 C-CERAMIC,CHIP;100nF,+80-20%,25V,Y5V,TP, |        |
| .....5   | R926     | 2007-000097 R-CHIP;47Kohm,5%,1/16W,DA,TP,1608        |        | .....5   | CC22     | 2203-000181 C-CERAMIC,CHIP;100nF,+80-20%,25V,Y5V,TP, |        |
| .....5   | R927     | 2007-000084 R-CHIP;4.7Kohm,5%,1/16W,DA,TP,1608       |        | .....5   | CC23     | 2402-001049 C-AL,CHIP;10uF,20%,16V,GP,TP,3.3x3.3x5.4 |        |
| .....5   | R928     | 2007-000084 R-CHIP;4.7Kohm,5%,1/16W,DA,TP,1608       |        | .....5   | CC24     | 2203-000181 C-CERAMIC,CHIP;100nF,+80-20%,25V,Y5V,TP, |        |
| .....5   | R930     | 2007-000078 R-CHIP;1Kohm,5%,1/16W,DA,TP,1608         |        | .....5   | CC25     | 2402-001049 C-AL,CHIP;10uF,20%,16V,GP,TP,3.3x3.3x5.4 |        |
| .....5   | R933     | 2007-000078 R-CHIP;1Kohm,5%,1/16W,DA,TP,1608         |        | .....5   | CC26     | 2203-000181 C-CERAMIC,CHIP;100nF,+80-20%,25V,Y5V,TP, |        |
| .....5   | R934     | 2007-000074 R-CHIP;100ohm,5%,1/16W,DA,TP,1608        |        | .....5   | CC27     | 2203-000181 C-CERAMIC,CHIP;100nF,+80-20%,25V,Y5V,TP, |        |
| .....5   | R936     | 2007-000078 R-CHIP;1Kohm,5%,1/16W,DA,TP,1608         |        | .....5   | CC28     | 2203-000181 C-CERAMIC,CHIP;100nF,+80-20%,25V,Y5V,TP, |        |
| .....5   | R939     | 2007-000074 R-CHIP;100ohm,5%,1/16W,DA,TP,1608        |        | .....5   | CC29     | 2203-000181 C-CERAMIC,CHIP;100nF,+80-20%,25V,Y5V,TP, |        |
| .....5   | R940     | 2007-000074 R-CHIP;100ohm,5%,1/16W,DA,TP,1608        |        | .....5   | CC30     | 2203-000181 C-CERAMIC,CHIP;100nF,+80-20%,25V,Y5V,TP, |        |
| .....5   | R941     | 2007-000123 R-CHIP;1.5Kohm,5%,1/16W,DA,TP,1608       |        | .....5   | CC31     | 2203-000181 C-CERAMIC,CHIP;100nF,+80-20%,25V,Y5V,TP, |        |
| .....5   | R942     | 2007-000123 R-CHIP;1.5Kohm,5%,1/16W,DA,TP,1608       |        | .....5   | CC32     | 2203-000181 C-CERAMIC,CHIP;100nF,+80-20%,25V,Y5V,TP, |        |
| .....5   | R944     | 2007-000090 R-CHIP;10KOHM,5%,1/16W,DA,TP,1608        |        | .....5   | CC33     | 2203-000181 C-CERAMIC,CHIP;100nF,+80-20%,25V,Y5V,TP, |        |
| .....5   | R945     | 2007-001167 R-CHIP;75ohm,5%,1/16W,DA,TP,1608         |        | .....5   | CC34     | 2203-000181 C-CERAMIC,CHIP;100nF,+80-20%,25V,Y5V,TP, |        |
| .....5   | R946     | 2007-001167 R-CHIP;75ohm,5%,1/16W,DA,TP,1608         |        | .....5   | CC35     | 2203-000626 C-CERAMIC,CHIP;0.022nF,5%,50V,NP0,TP,160 |        |
| .....5   | R948     | 2007-001167 R-CHIP;75ohm,5%,1/16W,DA,TP,1608         |        | .....5   | CC36     | 2203-000626 C-CERAMIC,CHIP;0.022nF,5%,50V,NP0,TP,160 |        |
| .....5   | R949     | 2007-001167 R-CHIP;75ohm,5%,1/16W,DA,TP,1608         |        | .....5   | CC37     | 2203-001223 C-CERAMIC,CHIP;0.82nF,10%,50V,X7R,TP,201 |        |
| .....5   | R950     | 2007-001167 R-CHIP;75ohm,5%,1/16W,DA,TP,1608         |        | .....5   | CC38     | 2203-000975 C-CERAMIC,CHIP;47nF,10%,25V,X7R,TP,1608, |        |
| .....5   | R951     | 2007-001167 R-CHIP;75ohm,5%,1/16W,DA,TP,1608         |        | .....5   | CC39     | 2203-000181 C-CERAMIC,CHIP;100nF,+80-20%,25V,Y5V,TP, |        |
| .....5   | R952     | 2007-000074 R-CHIP;100ohm,5%,1/16W,DA,TP,1608        |        | .....5   | CC40     | 2402-000179 C-AL,SMD;47uF,20%,16V,GP,TP,6.6x6.6x5.4  |        |
| .....5   | R953     | 2007-000074 R-CHIP;100ohm,5%,1/16W,DA,TP,1608        |        | .....5   | CC41     | 2203-000181 C-CERAMIC,CHIP;100nF,+80-20%,25V,Y5V,TP, |        |
| .....5   | R954     | 2007-000084 R-CHIP;4.7Kohm,5%,1/16W,DA,TP,1608       |        | .....5   | CC42     | 2203-001052 C-CERAMIC,CHIP;0.56nF,10%,50V,X7R,TP,160 |        |
| .....5   | R955     | 2007-000084 R-CHIP;4.7Kohm,5%,1/16W,DA,TP,1608       |        | .....5   | CC43     | 2203-000181 C-CERAMIC,CHIP;100nF,+80-20%,25V,Y5V,TP, |        |
| .....5   | R956     | 2007-000074 R-CHIP;100ohm,5%,1/16W,DA,TP,1608        |        | .....5   | CC44     | 2203-000181 C-CERAMIC,CHIP;100nF,+80-20%,25V,Y5V,TP, |        |
| .....5   | R957     | 2007-000090 R-CHIP;10KOHM,5%,1/16W,DA,TP,1608        |        | .....5   | CC45     | 2402-000179 C-AL,SMD;47uF,20%,16V,GP,TP,6.6x6.6x5.4  |        |
| .....5   | R958     | 2007-000084 R-CHIP;4.7Kohm,5%,1/16W,DA,TP,1608       |        | .....5   | CC46     | 2402-000179 C-AL,SMD;47uF,20%,16V,GP,TP,6.6x6.6x5.4  |        |
| .....5   | R959     | 2007-000070 R-CHIP;0ohm,5%,1/16W,DA,TP,1608          |        | .....5   | CC47     | 2402-000179 C-AL,SMD;47uF,20%,16V,GP,TP,6.6x6.6x5.4  |        |
| .....5   | R960     | 2007-000070 R-CHIP;0ohm,5%,1/16W,DA,TP,1608          |        | .....5   | CC48     | 2203-000181 C-CERAMIC,CHIP;100nF,+80-20%,25V,Y5V,TP, |        |
| .....5   | R961     | 2007-000939 R-CHIP;47Kohm,1%,1/16W,DA,TP,1608        |        | .....5   | CC49     | 2402-001070 C-AL,SMD;470uF,20%,16V,GP,TP,10x10.2,-   |        |
| .....5   | R962     | 2007-000583 R-CHIP;22Kohm,1%,1/16W,DA,TP,1608        |        | .....5   | CD01     | 0401-000133 DIODE-SWITCHING;RLS4148,100V,200MA,SOD-8 |        |
| .....5   | R963     | 2007-000077 R-CHIP;470ohm,5%,1/16W,DA,TP,1608        |        | .....5   | CF01     | 2909-001052 FILTER-LC;3.58MHz,3MHz,1.5dB,TP,11dB/1.0 |        |
| .....5   | R964     | 2007-000070 R-CHIP;0ohm,5%,1/16W,DA,TP,1608          |        | .....5   | CF02     | 2909-001051 FILTER-LC;6MHz,6MHz,0.8dB,TP,5dB/6MHz,30 |        |
| .....5   | R965     | 2007-000070 R-CHIP;0ohm,5%,1/16W,DA,TP,1608          |        | .....5   | CF03     | 2909-001051 FILTER-LC;6MHz,6MHz,0.8dB,TP,5dB/6MHz,30 |        |
| .....5   | R966     | 2007-000931 R-CHIP;470OHM,5%,1/10W,DA,TP,2012        |        | .....5   | CF04     | 2909-001051 FILTER-LC;6MHz,6MHz,0.8dB,TP,5dB/6MHz,30 |        |
| .....5   | R969     | 2007-000074 R-CHIP;100ohm,5%,1/16W,DA,TP,1608        |        | .....5   | CLO1     | 3301-001324 CORE-FERRITE BEAD;AB,150HM,2X1.25X0.9MM, |        |
| .....5   | R970     | 2007-000074 R-CHIP;100ohm,5%,1/16W,DA,TP,1608        |        | .....5   | CLO2     | 3301-001324 CORE-FERRITE BEAD;AB,150HM,2X1.25X0.9MM, |        |
| .....5   | R971     | 2007-000084 R-CHIP;4.7Kohm,5%,1/16W,DA,TP,1608       |        | .....5   | CLO3     | 3301-001324 CORE-FERRITE BEAD;AB,150HM,2X1.25X0.9MM, |        |
| .....5   | R972     | 2007-000074 R-CHIP;100ohm,5%,1/16W,DA,TP,1608        |        | .....5   | CLO4     | 3301-001324 CORE-FERRITE BEAD;AB,150HM,2X1.25X0.9MM, |        |
| .....5   | R974     | 2007-000078 R-CHIP;1Kohm,5%,1/16W,DA,TP,1608         |        | .....5   | CLO5     | 2703-000389 INDUCTOR-SMD;5.6uH,5%,3.2x2.5x2.2mm      |        |
| .....5   | R975     | 2007-000121 R-CHIP;820ohm,5%,1/16W,DA,TP,1608        |        | .....5   | CLO6     | 3301-001324 CORE-FERRITE BEAD;AB,150HM,2X1.25X0.9MM, |        |



| Loc. No. | Code No. | Description ; Specification | Remark                                     | Loc. No. | Code No. | Description ; Specification | Remark                                   |
|----------|----------|-----------------------------|--|----------|----------|-----------------------------|--|
| .....5   | CL07     | 2703-000398                 | INDUCTOR-SMD;10uH,10%,3.2x2.5x2.2mm        | .....5   | CR86     | 2007-000799                 | R-CHIP;360ohm,5%,1/16W,DA,TP,1608        |
| .....5   | CQ01     | 0501-000280                 | TR-SMALL SIGNAL;KSA1182,PNP,150mW,SOT-23   | .....5   | CR87     | 2007-000102                 | R-CHIP;100Kohm,5%,1/16W,DA,TP,1608       |
| .....5   | CQ02     | 0501-000280                 | TR-SMALL SIGNAL;KSA1182,PNP,150mW,SOT-23   | .....5   | CR88     | 2007-000070                 | R-CHIP;0ohm,5%,1/16W,DA,TP,1608          |
| .....5   | CQ03     | 0501-000344                 | TR-SMALL SIGNAL;KSC1623-G,NPN,200mW,SOT-23 | .....5   | EC01     | 2203-000181                 | C-CERAMIC,CHIP;100nF,+80-20%,25V,Y5V,TP, |
| .....5   | CQ04     | 0501-000280                 | TR-SMALL SIGNAL;KSA1182,PNP,150mW,SOT-23   | .....5   | EC02     | 2203-000181                 | C-CERAMIC,CHIP;100nF,+80-20%,25V,Y5V,TP, |
| .....5   | CQ05     | 0501-000344                 | TR-SMALL SIGNAL;KSC1623-G,NPN,200mW,SOT-23 | .....5   | EC03     | 2203-000181                 | C-CERAMIC,CHIP;100nF,+80-20%,25V,Y5V,TP, |
| .....5   | CQ06     | 0501-000280                 | TR-SMALL SIGNAL;KSA1182,PNP,150mW,SOT-23   | .....5   | EC04     | 2203-000181                 | C-CERAMIC,CHIP;100nF,+80-20%,25V,Y5V,TP, |
| .....5   | CQ07     | 0501-000344                 | TR-SMALL SIGNAL;KSC1623-G,NPN,200mW,SOT-23 | .....5   | EC07     | 2203-000975                 | C-CERAMIC,CHIP;47nF,10%,25V,X7R,TP,1608, |
| .....5   | CQ08     | 0501-000280                 | TR-SMALL SIGNAL;KSA1182,PNP,150mW,SOT-23   | .....5   | EC09     | 2203-000575                 | C-CERAMIC,CHIP;220NF,10%,25V,X7R,TP,2012 |
| .....5   | CQ09     | 0501-000344                 | TR-SMALL SIGNAL;KSC1623-G,NPN,200mW,SOT-23 | .....5   | EC10     | 2203-000575                 | C-CERAMIC,CHIP;220NF,10%,25V,X7R,TP,2012 |
| .....5   | CQ12     | 0501-000344                 | TR-SMALL SIGNAL;KSC1623-G,NPN,200mW,SOT-23 | .....5   | EC11     | 2203-000575                 | C-CERAMIC,CHIP;220NF,10%,25V,X7R,TP,2012 |
| .....5   | CQ13     | 0501-000280                 | TR-SMALL SIGNAL;KSA1182,PNP,150mW,SOT-23   | .....5   | EC12     | 2203-000181                 | C-CERAMIC,CHIP;100nF,+80-20%,25V,Y5V,TP, |
| .....5   | CQ14     | 0501-000280                 | TR-SMALL SIGNAL;KSA1182,PNP,150mW,SOT-23   | .....5   | EC13     | 2203-000181                 | C-CERAMIC,CHIP;100nF,+80-20%,25V,Y5V,TP, |
| .....5   | CQ15     | 0501-000344                 | TR-SMALL SIGNAL;KSC1623-G,NPN,200mW,SOT-23 | .....5   | EC14     | 2203-000975                 | C-CERAMIC,CHIP;47nF,10%,25V,X7R,TP,1608, |
| .....5   | CQ16     | 0501-000280                 | TR-SMALL SIGNAL;KSA1182,PNP,150mW,SOT-23   | .....5   | EC15     | 2203-000975                 | C-CERAMIC,CHIP;47nF,10%,25V,X7R,TP,1608, |
| .....5   | CQ17     | 0501-000280                 | TR-SMALL SIGNAL;KSA1182,PNP,150mW,SOT-23   | .....5   | EC16     | 2203-000975                 | C-CERAMIC,CHIP;47nF,10%,25V,X7R,TP,1608, |
| .....5   | CQ18     | 0501-000344                 | TR-SMALL SIGNAL;KSC1623-G,NPN,200mW,SOT-23 | .....5   | EC17     | 2203-000181                 | C-CERAMIC,CHIP;100nF,+80-20%,25V,Y5V,TP, |
| .....5   | CQ19     | 0501-000280                 | TR-SMALL SIGNAL;KSA1182,PNP,150mW,SOT-23   | .....5   | EC18     | 2203-000975                 | C-CERAMIC,CHIP;47nF,10%,25V,X7R,TP,1608, |
| .....5   | CQ20     | 0501-000344                 | TR-SMALL SIGNAL;KSC1623-G,NPN,200mW,SOT-23 | .....5   | EC19     | 2203-000975                 | C-CERAMIC,CHIP;47nF,10%,25V,X7R,TP,1608, |
| .....5   | CQ21     | 0501-000280                 | TR-SMALL SIGNAL;KSA1182,PNP,150mW,SOT-23   | .....5   | EC20     | 2203-000975                 | C-CERAMIC,CHIP;47nF,10%,25V,X7R,TP,1608, |
| .....5   | CR01     | 2007-000309                 | R-CHIP;10ohm,5%,1/16W,DA,TP,1608           | .....5   | EC21     | 2203-000975                 | C-CERAMIC,CHIP;47nF,10%,25V,X7R,TP,1608, |
| .....5   | CR02     | 2007-000124                 | R-CHIP;2.2Kohm,5%,1/16W,DA,TP,1608         | .....5   | EC22     | 2203-000975                 | C-CERAMIC,CHIP;47nF,10%,25V,X7R,TP,1608, |
| .....5   | CR03     | 2007-000078                 | R-CHIP;1Kohm,5%,1/16W,DA,TP,1608           | .....5   | EC23     | 2203-000975                 | C-CERAMIC,CHIP;47nF,10%,25V,X7R,TP,1608, |
| .....5   | CR04     | 2007-000096                 | R-CHIP;30Kohm,5%,1/16W,DA,TP,1608          | .....5   | EC24     | 2203-000975                 | C-CERAMIC,CHIP;47nF,10%,25V,X7R,TP,1608, |
| .....5   | CR05     | 2007-000078                 | R-CHIP;1Kohm,5%,1/16W,DA,TP,1608           | .....5   | EC25     | 2203-000181                 | C-CERAMIC,CHIP;100nF,+80-20%,25V,Y5V,TP, |
| .....5   | CR06     | 2007-000125                 | R-CHIP;3.9Kohm,5%,1/16W,DA,TP,1608         | .....5   | EC27     | 2203-000784                 | C-CERAMIC,CHIP;0.33nF,5%,50V,NPO,TP,2012 |
| .....5   | CR07     | 2007-000124                 | R-CHIP;2.2Kohm,5%,1/16W,DA,TP,1608         | .....5   | EC30     | 2007-001166                 | R-CHIP;750HM,5%,1/10W,DA,TP,2012         |
| .....5   | CR08     | 2007-000077                 | R-CHIP;470ohm,5%,1/16W,DA,TP,1608          | .....5   | EC31     | 2007-001166                 | R-CHIP;750HM,5%,1/10W,DA,TP,2012         |
| .....5   | CR09     | 2007-000077                 | R-CHIP;470ohm,5%,1/16W,DA,TP,1608          | .....5   | EC32     | 2203-005384                 | C-CERAMIC,CHIP;4700nF,+80-20%,10V,Y5V,TP |
| .....5   | CR10     | 2007-000074                 | R-CHIP;100ohm,5%,1/16W,DA,TP,1608          | .....5   | EC33     | 2203-005384                 | C-CERAMIC,CHIP;4700nF,+80-20%,10V,Y5V,TP |
| .....5   | CR11     | 2007-000234                 | R-CHIP;1.3Kohm,5%,1/16W,DA,TP,1608         | .....5   | EC34     | 2203-005384                 | C-CERAMIC,CHIP;4700nF,+80-20%,10V,Y5V,TP |
| .....5   | CR12     | 2007-000077                 | R-CHIP;470ohm,5%,1/16W,DA,TP,1608          | .....5   | EC35     | 2203-000681                 | C-CERAMIC,CHIP;0.027nF,5%,50V,NPO,TP,160 |
| .....5   | CR13     | 2007-000077                 | R-CHIP;470ohm,5%,1/16W,DA,TP,1608          | .....5   | EC36     | 2203-000681                 | C-CERAMIC,CHIP;0.027nF,5%,50V,NPO,TP,160 |
| .....5   | CR14     | 2007-000290                 | R-CHIP;1000HM,5%,1/10W,DA,TP,2012          | .....5   | EC37     | 2203-000681                 | C-CERAMIC,CHIP;0.027nF,5%,50V,NPO,TP,160 |
| .....5   | CR15     | 2007-000309                 | R-CHIP;10ohm,5%,1/16W,DA,TP,1608           | .....5   | EC39     | 2203-000783                 | C-CERAMIC,CHIP;0.33nF,5%,50V,NPO,TP,1608 |
| .....5   | CR16     | 2007-000124                 | R-CHIP;2.2Kohm,5%,1/16W,DA,TP,1608         | .....5   | EC40     | 2203-000783                 | C-CERAMIC,CHIP;0.33nF,5%,50V,NPO,TP,1608 |
| .....5   | CR17     | 2007-000119                 | R-CHIP;560ohm,5%,1/16W,DA,TP,1608          | .....5   | EC61     | 2203-000181                 | C-CERAMIC,CHIP;100nF,+80-20%,25V,Y5V,TP, |
| .....5   | CR18     | 2007-000086                 | R-CHIP;5.6Kohm,5%,1/16W,DA,TP,1608         | .....5   | EC62     | 2203-000181                 | C-CERAMIC,CHIP;100nF,+80-20%,25V,Y5V,TP, |
| .....5   | CR19     | 2007-000077                 | R-CHIP;470ohm,5%,1/16W,DA,TP,1608          | .....5   | EC63     | 2203-000626                 | C-CERAMIC,CHIP;0.022nF,5%,50V,NPO,TP,160 |
| .....5   | CR20     | 2007-000077                 | R-CHIP;470ohm,5%,1/16W,DA,TP,1608          | .....5   | EC64     | 2203-000626                 | C-CERAMIC,CHIP;0.022nF,5%,50V,NPO,TP,160 |
| .....5   | CR21     | 2007-000074                 | R-CHIP;100ohm,5%,1/16W,DA,TP,1608          | .....5   | EC65     | 2203-000181                 | C-CERAMIC,CHIP;100nF,+80-20%,25V,Y5V,TP, |
| .....5   | CR22     | 2007-000211                 | R-CHIP;1.1Kohm,5%,1/16W,DA,TP,1608         | .....5   | EC66     | 2203-000181                 | C-CERAMIC,CHIP;100nF,+80-20%,25V,Y5V,TP, |
| .....5   | CR23     | 2007-000113                 | R-CHIP;330ohm,5%,1/16W,DA,TP,1608          | .....5   | EC67     | 2203-000181                 | C-CERAMIC,CHIP;100nF,+80-20%,25V,Y5V,TP, |
| .....5   | CR24     | 2007-000077                 | R-CHIP;470ohm,5%,1/16W,DA,TP,1608          | .....5   | EC68     | 2203-000181                 | C-CERAMIC,CHIP;100nF,+80-20%,25V,Y5V,TP, |
| .....5   | CR25     | 2007-000290                 | R-CHIP;1000HM,5%,1/10W,DA,TP,2012          | .....5   | EC69     | 2203-000181                 | C-CERAMIC,CHIP;100nF,+80-20%,25V,Y5V,TP, |
| .....5   | CR38     | 2007-000074                 | R-CHIP;100ohm,5%,1/16W,DA,TP,1608          | .....5   | EC70     | 2203-000181                 | C-CERAMIC,CHIP;100nF,+80-20%,25V,Y5V,TP, |
| .....5   | CR39     | 2007-000074                 | R-CHIP;100ohm,5%,1/16W,DA,TP,1608          | .....5   | EL01     | 2703-000274                 | INDUCTOR-SMD;2.2uH,10%,1.25x2x0.85mm     |
| .....5   | CR40     | 2007-000094                 | R-CHIP;22Kohm,5%,1/16W,DA,TP,1608          | .....5   | EL02     | 2703-000274                 | INDUCTOR-SMD;2.2uH,10%,1.25x2x0.85mm     |
| .....5   | CR41     | 2007-000088                 | R-CHIP;7.5Kohm,5%,1/16W,DA,TP,1608         | .....5   | EL03     | 2703-000274                 | INDUCTOR-SMD;2.2uH,10%,1.25x2x0.85mm     |
| .....5   | CR42     | 2007-000309                 | R-CHIP;10ohm,5%,1/16W,DA,TP,1608           | .....5   | EL04     | 2703-000274                 | INDUCTOR-SMD;2.2uH,10%,1.25x2x0.85mm     |
| .....5   | CR43     | 2007-000078                 | R-CHIP;1Kohm,5%,1/16W,DA,TP,1608           | .....5   | EL05     | 2703-000274                 | INDUCTOR-SMD;2.2uH,10%,1.25x2x0.85mm     |
| .....5   | CR44     | 2007-000119                 | R-CHIP;560ohm,5%,1/16W,DA,TP,1608          | .....5   | EL06     | 2703-000274                 | INDUCTOR-SMD;2.2uH,10%,1.25x2x0.85mm     |
| .....5   | CR45     | 2007-000086                 | R-CHIP;5.6Kohm,5%,1/16W,DA,TP,1608         | .....5   | EL07     | 2703-000274                 | INDUCTOR-SMD;2.2uH,10%,1.25x2x0.85mm     |
| .....5   | CR46     | 2007-000074                 | R-CHIP;100ohm,5%,1/16W,DA,TP,1608          | .....5   | EL08     | 2703-000274                 | INDUCTOR-SMD;2.2uH,10%,1.25x2x0.85mm     |
| .....5   | CR47     | 2007-000119                 | R-CHIP;560ohm,5%,1/16W,DA,TP,1608          | .....5   | EL09     | 3301-001324                 | CORE-FERRITE BEAD;AB,150HM,2X1.25X0.9MM, |
| .....5   | CR48     | 2007-001157                 | R-CHIP;750ohm,5%,1/16W,DA,TP,1608          | .....5   | EQ11     | 0505-000110                 | FET-SILICON;2N7002,N,60V,115MA,7.50HM,0. |
| .....5   | CR49     | 2007-000074                 | R-CHIP;100ohm,5%,1/16W,DA,TP,1608          | .....5   | EQ12     | 0505-000110                 | FET-SILICON;2N7002,N,60V,115MA,7.50HM,0. |
| .....5   | CR50     | 2007-000078                 | R-CHIP;1Kohm,5%,1/16W,DA,TP,1608           | .....5   | EQ13     | 0501-000344                 | TR-SMALL SIGNAL;KSC1623-G,NPN,200mW,SOT- |
| .....5   | CR51     | 2007-000094                 | R-CHIP;22Kohm,5%,1/16W,DA,TP,1608          | .....5   | EQ14     | 0501-000344                 | TR-SMALL SIGNAL;KSC1623-G,NPN,200mW,SOT- |
| .....5   | CR52     | 2007-000088                 | R-CHIP;7.5Kohm,5%,1/16W,DA,TP,1608         | .....5   | EQ15     | 0501-000344                 | TR-SMALL SIGNAL;KSC1623-G,NPN,200mW,SOT- |
| .....5   | CR53     | 2007-000078                 | R-CHIP;1Kohm,5%,1/16W,DA,TP,1608           | .....5   | ER03     | 2007-001166                 | R-CHIP;750HM,5%,1/10W,DA,TP,2012         |
| .....5   | CR54     | 2007-000078                 | R-CHIP;1Kohm,5%,1/16W,DA,TP,1608           | .....5   | ER04     | 2007-000070                 | R-CHIP;0ohm,5%,1/16W,DA,TP,1608          |
| .....5   | CR55     | 2007-000119                 | R-CHIP;560ohm,5%,1/16W,DA,TP,1608          | .....5   | ER05     | 2007-000070                 | R-CHIP;0ohm,5%,1/16W,DA,TP,1608          |
| .....5   | CR56     | 2007-000086                 | R-CHIP;5.6Kohm,5%,1/16W,DA,TP,1608         | .....5   | ER06     | 2007-000070                 | R-CHIP;0ohm,5%,1/16W,DA,TP,1608          |
| .....5   | CR57     | 2007-000074                 | R-CHIP;100ohm,5%,1/16W,DA,TP,1608          | .....5   | ER08     | 2007-000290                 | R-CHIP;1000HM,5%,1/10W,DA,TP,2012        |
| .....5   | CR58     | 2007-000119                 | R-CHIP;560ohm,5%,1/16W,DA,TP,1608          | .....5   | ER09     | 2007-001166                 | R-CHIP;750HM,5%,1/10W,DA,TP,2012         |
| .....5   | CR59     | 2007-001093                 | R-CHIP;620ohm,5%,1/16W,DA,TP,1608          | .....5   | ER10     | 2007-001166                 | R-CHIP;750HM,5%,1/10W,DA,TP,2012         |
| .....5   | CR60     | 2007-000074                 | R-CHIP;100ohm,5%,1/16W,DA,TP,1608          | .....5   | ER11     | 2007-001166                 | R-CHIP;750HM,5%,1/10W,DA,TP,2012         |
| .....5   | CR61     | 2007-000078                 | R-CHIP;1Kohm,5%,1/16W,DA,TP,1608           | .....5   | ER12     | 2007-001166                 | R-CHIP;750HM,5%,1/10W,DA,TP,2012         |
| .....5   | CR70     | 2007-000075                 | R-CHIP;220ohm,5%,1/16W,DA,TP,1608          | .....5   | ER13     | 2007-000070                 | R-CHIP;0ohm,5%,1/16W,DA,TP,1608          |
| .....5   | CR71     | 2007-000078                 | R-CHIP;1Kohm,5%,1/16W,DA,TP,1608           | .....5   | ER14     | 2007-001166                 | R-CHIP;750HM,5%,1/10W,DA,TP,2012         |
| .....5   | CR72     | 2007-000097                 | R-CHIP;47Kohm,5%,1/16W,DA,TP,1608          | .....5   | ER15     | 2007-000290                 | R-CHIP;1000HM,5%,1/10W,DA,TP,2012        |
| .....5   | CR73     | 2007-000124                 | R-CHIP;2.2Kohm,5%,1/16W,DA,TP,1608         | .....5   | ER16     | 2007-000290                 | R-CHIP;1000HM,5%,1/10W,DA,TP,2012        |
| .....5   | CR74     | 2007-000106                 | R-CHIP;220Kohm,5%,1/16W,DA,TP,1608         | .....5   | ER17     | 2007-000070                 | R-CHIP;0ohm,5%,1/16W,DA,TP,1608          |
| .....5   | CR75     | 2007-000077                 | R-CHIP;470ohm,5%,1/16W,DA,TP,1608          | .....5   | ER18     | 2007-000070                 | R-CHIP;0ohm,5%,1/16W,DA,TP,1608          |
| .....5   | CR76     | 2007-000084                 | R-CHIP;4.7Kohm,5%,1/16W,DA,TP,1608         | .....5   | ER19     | 2007-000070                 | R-CHIP;0ohm,5%,1/16W,DA,TP,1608          |
| .....5   | CR85     | 2007-000075                 | R-CHIP;220ohm,5%,1/16W,DA,TP,1608          | .....5   | ER20     | 2007-000097                 | R-CHIP;47Kohm,5%,1/16W,DA,TP,1608        |

| Loc. No. | Code No. | Description ; Specification                          | Remark | Loc. No. | Code No. | Description ; Specification                          | Remark |
|----------|----------|--|--------|----------|----------|--|--------|
| .....5   | ER21     | 2007-000097 R-CHIP;47Kohm,5%,1/16W,DA,TP,1608        |        | .....5   | FL01     | 2703-001070 INDUCTOR-SMD;100uH,10%,4.5x3.2x3.2mm     |        |
| .....5   | ER22     | 2007-000097 R-CHIP;47Kohm,5%,1/16W,DA,TP,1608        |        | .....5   | FQ02     | 0501-000280 TR-SMALL SIGNAL;KSA1182,PNP,150mW,SOT-23 |        |
| .....5   | ER23     | 2007-000097 R-CHIP;47Kohm,5%,1/16W,DA,TP,1608        |        | .....5   | FQ03     | 0501-000280 TR-SMALL SIGNAL;KSA1182,PNP,150mW,SOT-23 |        |
| .....5   | ER24     | 2007-000097 R-CHIP;47Kohm,5%,1/16W,DA,TP,1608        |        | .....5   | FQ04     | 0501-000280 TR-SMALL SIGNAL;KSA1182,PNP,150mW,SOT-23 |        |
| .....5   | ER25     | 2007-000097 R-CHIP;47Kohm,5%,1/16W,DA,TP,1608        |        | .....5   | FQ05     | 0501-000344 TR-SMALL SIGNAL;KSC1623-G,NPN,200mW,SOT- |        |
| .....5   | ER26     | 2007-000931 R-CHIP;470OHM,5%,1/10W,DA,TP,2012        |        | .....5   | FQ06     | 0501-000344 TR-SMALL SIGNAL;KSC1623-G,NPN,200mW,SOT- |        |
| .....5   | ER27     | 2007-000931 R-CHIP;470OHM,5%,1/10W,DA,TP,2012        |        | .....5   | FQ07     | 0501-000727 TR-SMALL SIGNAL;BC848C,NPN,310mW,SOT-23, |        |
| .....5   | ER28     | 2007-000931 R-CHIP;470OHM,5%,1/10W,DA,TP,2012        |        | .....5   | FQ08     | 0501-000344 TR-SMALL SIGNAL;KSC1623-G,NPN,200mW,SOT- |        |
| .....5   | ER29     | 2007-000070 R-CHIP;0ohm,5%,1/16W,DA,TP,1608          |        | .....5   | FQ09     | 0501-000344 TR-SMALL SIGNAL;KSC1623-G,NPN,200mW,SOT- |        |
| .....5   | ER82     | 2007-000074 R-CHIP;100ohm,5%,1/16W,DA,TP,1608        |        | .....5   | FQ12     | 0501-000344 TR-SMALL SIGNAL;KSC1623-G,NPN,200mW,SOT- |        |
| .....5   | ER83     | 2007-000074 R-CHIP;100ohm,5%,1/16W,DA,TP,1608        |        | .....5   | FQ13     | 0501-000280 TR-SMALL SIGNAL;KSA1182,PNP,150mW,SOT-23 |        |
| .....5   | ER84     | 2007-000074 R-CHIP;100ohm,5%,1/16W,DA,TP,1608        |        | .....5   | FR01     | 2007-000074 R-CHIP;100ohm,5%,1/16W,DA,TP,1608        |        |
| .....5   | ER90     | 2007-000029 R-CHIP;0OHM,5%,1/10W,DA,TP,2012          |        | .....5   | FR02     | 2007-000074 R-CHIP;100ohm,5%,1/16W,DA,TP,1608        |        |
| .....5   | ER91     | 2007-000084 R-CHIP;4.7Kohm,5%,1/16W,DA,TP,1608       |        | .....5   | FR03     | 2007-000074 R-CHIP;100ohm,5%,1/16W,DA,TP,1608        |        |
| .....5   | ER92     | 2007-000084 R-CHIP;4.7Kohm,5%,1/16W,DA,TP,1608       |        | .....5   | FR07     | 2007-000070 R-CHIP;0ohm,5%,1/16W,DA,TP,1608          |        |
| .....5   | FC01     | 2203-000440 C-CERAMIC,CHIP;1nF,10%,50V,X7R,TP,1608,- |        | .....5   | FR08     | 2007-000074 R-CHIP;100ohm,5%,1/16W,DA,TP,1608        |        |
| .....5   | FC02     | 2203-000440 C-CERAMIC,CHIP;1nF,10%,50V,X7R,TP,1608,- |        | .....5   | FR09     | 2007-000090 R-CHIP;10KOHM,5%,1/16W,DA,TP,1608        |        |
| .....5   | FC03     | 2203-000181 C-CERAMIC,CHIP;100nF,+80-20%,25V,Y5V,TP, |        | .....5   | FR10     | 2007-000210 R-CHIP;1.1KOHM,5%,1/10W,DA,TP,2012       |        |
| .....5   | FC04     | 2402-001042 C-AL,SMD;100uF,20%,16V,GP,TP,6.6x6.6x5.4 |        | .....5   | FR11     | 2007-000210 R-CHIP;1.1KOHM,5%,1/10W,DA,TP,2012       |        |
| .....5   | FC05     | 2203-000181 C-CERAMIC,CHIP;100nF,+80-20%,25V,Y5V,TP, |        | .....5   | FR12     | 2007-000210 R-CHIP;1.1KOHM,5%,1/10W,DA,TP,2012       |        |
| .....5   | FC06     | 2402-001049 C-AL,CHIP;10uF,20%,16V,GP,TP,3.3x3.3x5.4 |        | .....5   | FR13     | 2007-000210 R-CHIP;1.1KOHM,5%,1/10W,DA,TP,2012       |        |
| .....5   | FC07     | 2203-000491 C-CERAMIC,CHIP;2.2nF,10%,50V,X7R,TP,1608 |        | .....5   | FR14     | 2007-000210 R-CHIP;1.1KOHM,5%,1/10W,DA,TP,2012       |        |
| .....5   | FC08     | 2203-002494 C-CERAMIC,CHIP;470nF,10%,16V,X7R,TP,2012 |        | .....5   | FR15     | 2007-000210 R-CHIP;1.1KOHM,5%,1/10W,DA,TP,2012       |        |
| .....5   | FC09     | 2402-000170 C-AL,SMD;1uF,20%,50V,GP,TP,4.3x4.3x5.4,  |        | .....5   | FR16     | 2007-000074 R-CHIP;100ohm,5%,1/16W,DA,TP,1608        |        |
| .....5   | FC10     | 2203-000181 C-CERAMIC,CHIP;100nF,+80-20%,25V,Y5V,TP, |        | .....5   | FR17     | 2007-000074 R-CHIP;100ohm,5%,1/16W,DA,TP,1608        |        |
| .....5   | FC11     | 2203-000181 C-CERAMIC,CHIP;100nF,+80-20%,25V,Y5V,TP, |        | .....5   | FR18     | 2007-000074 R-CHIP;100ohm,5%,1/16W,DA,TP,1608        |        |
| .....5   | FC12     | 2402-001042 C-AL,SMD;100uF,20%,16V,GP,TP,6.6x6.6x5.4 |        | .....5   | FR19     | 2007-000074 R-CHIP;100ohm,5%,1/16W,DA,TP,1608        |        |
| .....5   | FC21     | 2203-000181 C-CERAMIC,CHIP;100nF,+80-20%,25V,Y5V,TP, |        | .....5   | FR20     | 2007-000074 R-CHIP;100ohm,5%,1/16W,DA,TP,1608        |        |
| .....5   | FC22     | 2203-000181 C-CERAMIC,CHIP;100nF,+80-20%,25V,Y5V,TP, |        | .....5   | FR21     | 2007-000074 R-CHIP;100ohm,5%,1/16W,DA,TP,1608        |        |
| .....5   | FC23     | 2203-000181 C-CERAMIC,CHIP;100nF,+80-20%,25V,Y5V,TP, |        | .....5   | FR22     | 2007-000090 R-CHIP;10KOHM,5%,1/16W,DA,TP,1608        |        |
| .....5   | FC24     | 2203-000181 C-CERAMIC,CHIP;100nF,+80-20%,25V,Y5V,TP, |        | .....5   | FR31     | 2007-000074 R-CHIP;100ohm,5%,1/16W,DA,TP,1608        |        |
| .....5   | FC25     | 2203-000181 C-CERAMIC,CHIP;100nF,+80-20%,25V,Y5V,TP, |        | .....5   | FR32     | 2007-000074 R-CHIP;100ohm,5%,1/16W,DA,TP,1608        |        |
| .....5   | FC26     | 2203-000181 C-CERAMIC,CHIP;100nF,+80-20%,25V,Y5V,TP, |        | .....5   | FR33     | 2007-000074 R-CHIP;100ohm,5%,1/16W,DA,TP,1608        |        |
| .....5   | FC27     | 2203-002494 C-CERAMIC,CHIP;470nF,10%,16V,X7R,TP,2012 |        | .....5   | FR34     | 2007-000074 R-CHIP;100ohm,5%,1/16W,DA,TP,1608        |        |
| .....5   | FC28     | 2203-002494 C-CERAMIC,CHIP;470nF,10%,16V,X7R,TP,2012 |        | .....5   | FR35     | 2007-000070 R-CHIP;0ohm,5%,1/16W,DA,TP,1608          |        |
| .....5   | FC29     | 2402-000173 C-AL,SMD;4.7uF,20%,35V,GP,TP,4.3x4.3x5.4 |        | .....5   | FR36     | 2007-000691 R-CHIP;3.3KOHM,5%,1/16W,DA,TP,1608       |        |
| .....5   | FC30     | 2203-000181 C-CERAMIC,CHIP;100nF,+80-20%,25V,Y5V,TP, |        | .....5   | FR37     | 2007-000074 R-CHIP;100ohm,5%,1/16W,DA,TP,1608        |        |
| .....5   | FC31     | 2402-001070 C-AL,SMD;470uF,20%,16V,GP,TP,10x10x12,-  |        | .....5   | FR38     | 2007-000074 R-CHIP;100ohm,5%,1/16W,DA,TP,1608        |        |
| .....5   | FC32     | 2203-000181 C-CERAMIC,CHIP;100nF,+80-20%,25V,Y5V,TP, |        | .....5   | FR39     | 2007-000074 R-CHIP;100ohm,5%,1/16W,DA,TP,1608        |        |
| .....5   | FC41     | 2203-000181 C-CERAMIC,CHIP;100nF,+80-20%,25V,Y5V,TP, |        | .....5   | FR40     | 2007-000080 R-CHIP;2Kohm,5%,1/16W,DA,TP,1608         |        |
| .....5   | FC42     | 2203-000181 C-CERAMIC,CHIP;100nF,+80-20%,25V,Y5V,TP, |        | .....5   | FR41     | 2007-000086 R-CHIP;5.6Kohm,5%,1/16W,DA,TP,1608       |        |
| .....5   | FC43     | 2203-000181 C-CERAMIC,CHIP;100nF,+80-20%,25V,Y5V,TP, |        | .....5   | FR42     | 2007-000086 R-CHIP;5.6Kohm,5%,1/16W,DA,TP,1608       |        |
| .....5   | FC44     | 2203-000181 C-CERAMIC,CHIP;100nF,+80-20%,25V,Y5V,TP, |        | .....5   | FR43     | 2007-000869 R-CHIP;4.7Kohm,5%,1/16W,DA,TP,1608       |        |
| .....5   | FC45     | 2402-001042 C-AL,SMD;100uF,20%,16V,GP,TP,6.6x6.6x5.4 |        | .....5   | FR44     | 2007-000084 R-CHIP;4.7Kohm,5%,1/16W,DA,TP,1608       |        |
| .....5   | FC46     | 2203-002494 C-CERAMIC,CHIP;470nF,10%,16V,X7R,TP,2012 |        | .....5   | FR45     | 2007-000084 R-CHIP;4.7Kohm,5%,1/16W,DA,TP,1608       |        |
| .....5   | FC47     | 2203-000575 C-CERAMIC,CHIP;220nF,10%,25V,X7R,TP,2012 |        | .....5   | FR46     | 2007-000493 R-CHIP;2.2KOHM,5%,1/10W,DA,TP,2012       |        |
| .....5   | FC48     | 2203-002494 C-CERAMIC,CHIP;470nF,10%,16V,X7R,TP,2012 |        | .....5   | FR47     | 2007-000493 R-CHIP;2.2KOHM,5%,1/10W,DA,TP,2012       |        |
| .....5   | FC49     | 2203-000891 C-CERAMIC,CHIP;4.7nF,10%,50V,X7R,TP,2012 |        | .....5   | FR53     | 2007-000074 R-CHIP;100ohm,5%,1/16W,DA,TP,1608        |        |
| .....5   | FC50     | 2203-001680 C-CERAMIC,CHIP;68nF,20%,50V,Z5U,TP,2012  |        | .....5   | FR54     | 2007-000074 R-CHIP;100ohm,5%,1/16W,DA,TP,1608        |        |
| .....5   | FC52     | 2203-000206 C-CERAMIC,CHIP;100nF,10%,50V,X7R,TP,2012 |        | .....5   | FR55     | 2007-000074 R-CHIP;100ohm,5%,1/16W,DA,TP,1608        |        |
| .....5   | FC53     | 2203-000206 C-CERAMIC,CHIP;100nF,10%,50V,X7R,TP,2012 |        | .....5   | FR56     | 2007-000074 R-CHIP;100ohm,5%,1/16W,DA,TP,1608        |        |
| .....5   | FC54     | 2203-000257 C-CERAMIC,CHIP;10nF,10%,50V,X7R,TP,1608  |        | .....5   | FR57     | 2007-000052 R-CHIP;10Kohm,1%,1/16W,DA,TP,1608        |        |
| .....5   | FC55     | 2203-000181 C-CERAMIC,CHIP;100nF,+80-20%,25V,Y5V,TP, |        | .....5   | FR58     | 2007-000092 R-CHIP;15Kohm,5%,1/16W,DA,TP,1608        |        |
| .....5   | FC57     | 2203-000440 C-CERAMIC,CHIP;1nF,10%,50V,X7R,TP,1608,- |        | .....5   | FR60     | 2007-000090 R-CHIP;10KOHM,5%,1/16W,DA,TP,1608        |        |
| .....5   | FC60     | 2402-000173 C-AL,SMD;4.7uF,20%,35V,GP,TP,4.3x4.3x5.4 |        | .....5   | FR62     | 2007-000082 R-CHIP;3.3Kohm,5%,1/16W,DA,TP,1608       |        |
| .....5   | FC61     | 2203-000181 C-CERAMIC,CHIP;100nF,+80-20%,25V,Y5V,TP, |        | .....5   | FR63     | 2007-000118 R-CHIP;390ohm,5%,1/16W,DA,TP,1608        |        |
| .....5   | FC62     | 2402-001042 C-AL,SMD;100uF,20%,16V,GP,TP,6.6x6.6x5.4 |        | .....5   | FR66     | 2007-000077 R-CHIP;470ohm,5%,1/16W,DA,TP,1608        |        |
| .....5   | FC63     | 2402-001042 C-AL,SMD;100uF,20%,16V,GP,TP,6.6x6.6x5.4 |        | .....5   | FR67     | 2007-000074 R-CHIP;100ohm,5%,1/16W,DA,TP,1608        |        |
| .....5   | FC64     | 2203-000181 C-CERAMIC,CHIP;100nF,+80-20%,25V,Y5V,TP, |        | .....5   | FR70     | 2007-000124 R-CHIP;2.2Kohm,5%,1/16W,DA,TP,1608       |        |
| .....5   | FC65     | 2402-001049 C-AL,CHIP;10uF,20%,16V,GP,TP,3.3x3.3x5.4 |        | .....5   | FR71     | 2007-000074 R-CHIP;100ohm,5%,1/16W,DA,TP,1608        |        |
| .....5   | FD01     | 0401-000133 DIODE-SWITCHING;RLS4148,100V,200MA,SOD-8 |        | .....5   | FR72     | 2007-000081 R-CHIP;2.7Kohm,5%,1/16W,DA,TP,1608       |        |
| .....5   | FD02     | 0401-000133 DIODE-SWITCHING;RLS4148,100V,200MA,SOD-8 |        | .....5   | FR73     | 2007-000082 R-CHIP;3.3Kohm,5%,1/16W,DA,TP,1608       |        |
| .....5   | FD03     | 0403-001117 DIODE-ZENER;RLZ12B,5%,500mW,LL-34,TP     |        | .....5   | FR74     | 2007-000074 R-CHIP;100ohm,5%,1/16W,DA,TP,1608        |        |
| .....5   | FD04     | 0403-001117 DIODE-ZENER;RLZ12B,5%,500mW,LL-34,TP     |        | .....5   | FR75     | 2007-000074 R-CHIP;100ohm,5%,1/16W,DA,TP,1608        |        |
| .....5   | FD05     | 0403-001117 DIODE-ZENER;RLZ12B,5%,500mW,LL-34,TP     |        | .....5   | FR76     | 2007-000070 R-CHIP;0ohm,5%,1/16W,DA,TP,1608          |        |
| .....5   | FD06     | 0403-001117 DIODE-ZENER;RLZ12B,5%,500mW,LL-34,TP     |        | .....5   | FR77     | 2007-000941 R-CHIP;47KOHM,5%,1/10W,DA,TP,2012        |        |
| .....5   | FD07     | 0401-000133 DIODE-SWITCHING;RLS4148,100V,200MA,SOD-8 |        | .....5   | FR78     | 2007-000297 R-CHIP;10KOHM,1%,1/10W,DA,TP,2012        |        |
| .....5   | FD08     | 0401-000133 DIODE-SWITCHING;RLS4148,100V,200MA,SOD-8 |        | .....5   | FR79     | 2007-000297 R-CHIP;10KOHM,1%,1/10W,DA,TP,2012        |        |
| .....5   | FD09     | 0401-000133 DIODE-SWITCHING;RLS4148,100V,200MA,SOD-8 |        | .....5   | FR80     | 2007-000297 R-CHIP;10KOHM,1%,1/10W,DA,TP,2012        |        |
| .....5   | FD10     | 0401-000133 DIODE-SWITCHING;RLS4148,100V,200MA,SOD-8 |        | .....5   | FR81     | 2007-000074 R-CHIP;100ohm,5%,1/16W,DA,TP,1608        |        |
| .....5   | FD11     | 0403-001016 DIODE-ZENER;RLZ2B,6.2V,5.96-6.27V,400m   |        | .....5   | FR82     | 2007-000074 R-CHIP;100ohm,5%,1/16W,DA,TP,1608        |        |
| .....5   | FD12     | 0403-000746 DIODE-ZENER;RLZ3,9B,3.9V,3.89-4.16V,400m |        | .....5   | FR96     | 2007-000070 R-CHIP;0ohm,5%,1/16W,DA,TP,1608          |        |
| .....5   | FD13     | 0401-000133 DIODE-SWITCHING;RLS4148,100V,200MA,SOD-8 |        | .....5   | IC01A    | 1204-001938 IC-DECODER;VSP9407B-B11,MQFF,80P,14X14MM |        |
| .....5   | FD14     | 0401-000133 DIODE-SWITCHING;RLS4148,100V,200MA,SOD-8 |        | .....5   | IC02     | 1204-001814 IC-SELECTOR;CXA2151Q,QFP,48P,144MIL,PLAS | S.N.A  |
| .....5   | FD15     | 0401-000133 DIODE-SWITCHING;RLS4148,100V,200MA,SOD-8 |        | .....5   | IC03     | 1001-001082 IC-VIDEO SWITCH;BA7657F,-SOP,24P,300MIL  |        |
| .....5   | FD16     | 0401-000133 DIODE-SWITCHING;RLS4148,100V,200MA,SOD-8 |        | .....5   | IC04     | 1204-001989 IC-VIDEO PROCESS;CXA2165Q,QFP,64P,20X14M | S.N.A  |
| .....5   | FD17     | 0401-000133 DIODE-SWITCHING;RLS4148,100V,200MA,SOD-8 |        | .....5   | IC05     | 1203-002186 IC-POSI.FIXED REG.;18,DPAK,3P,240MIL,PLA |        |

| Loc. No. | Code No. | Description ; Specification | Remark                                    | Loc. No. | Code No. | Description ; Specification | Remark                                  |  |
|----------|----------|-----------------------------|---|----------|----------|-----------------------------|---|--|
| .....5   | IC06     | 1203-001211                 | IC-VOL. DETECTOR;7027,SOT-89,3P,-,PLASTI  |          | .....5   | SC26                        | 2203-002494                             | C-CERAMIC,CHIP;470nF,10%,16V,X7R,TP,2012 |
| .....5   | IC07     | 1203-002470                 | IC-POSJ.ADJUST REG.;FAN1616AS25X,SOT-223  |          | .....5   | SC31                        | 2402-000179                             | C-AL,SMD;47uF,20%,16V,GP,TP,6.6x6.6x5.4  |
| .....5   | IC08     | 1203-001419                 | IC-VOLTAGE REGULATOR;4931,TO-252,3P,6.6x  |          | .....5   | SC32                        | 2203-001656                             | C-CERAMIC,CHIP;0.47nF,5%,50V,NPO,TP,1608 |
| .....5   | IC09     | 1204-001935                 | IC-SEPARATOR;UPD64083GF,QFP,100P,14X20MM  | S.N.A    | .....5   | SC33                        | 2203-000257                             | C-CERAMIC,CHIP;10nF,10%,50V,X7R,TP,1608  |
| .....5   | IC11     | 1203-002302                 | IC-POSJ.FIXED REG.;78RM33D,D-PAK,3P,-,PL  |          | .....5   | SC34                        | 2402-000179                             | C-AL,SMD;47uF,20%,16V,GP,TP,6.6x6.6x5.4  |
| .....5   | IC13     | 0801-000662                 | IC-CMOS LOGIC;74HC123,MULTIVIBRATOR,SOP,1 |          | .....5   | SC35                        | 2203-000257                             | C-CERAMIC,CHIP;10nF,10%,50V,X7R,TP,1608  |
| .....5   | IC14     | 3301-001324                 | CORE-FERRITE BEAD;AB,150HM,2X1.25X0.9MM,  |          | .....5   | SC36                        | 2402-000179                             | C-AL,SMD;47uF,20%,16V,GP,TP,6.6x6.6x5.4  |
| .....5   | IC15     | 3301-001324                 | CORE-FERRITE BEAD;AB,150HM,2X1.25X0.9MM,  |          | .....5   | SC37                        | 2203-000257                             | C-CERAMIC,CHIP;10nF,10%,50V,X7R,TP,1608  |
| .....5   | PC01     | 2402-000179                 | C-AL,SMD;47uF,20%,16V,GP,TP,6.6x6.6x5.4   |          | .....5   | SC38                        | 2402-000179                             | C-AL,SMD;47uF,20%,16V,GP,TP,6.6x6.6x5.4  |
| .....5   | PC02     | 2203-000181                 | C-CERAMIC,CHIP;100nF,+80-20%,25V,Y5V,TP,  |          | .....5   | SC39                        | 2203-000257                             | C-CERAMIC,CHIP;10nF,10%,50V,X7R,TP,1608  |
| .....5   | PC03     | 2402-000179                 | C-AL,SMD;47uF,20%,16V,GP,TP,6.6x6.6x5.4   |          | .....5   | SC40                        | 2402-000179                             | C-AL,SMD;47uF,20%,16V,GP,TP,6.6x6.6x5.4  |
| .....5   | PC04     | 2203-000181                 | C-CERAMIC,CHIP;100nF,+80-20%,25V,Y5V,TP,  |          | .....5   | SC41                        | 2203-000257                             | C-CERAMIC,CHIP;10nF,10%,50V,X7R,TP,1608  |
| .....5   | PC05     | 2203-000181                 | C-CERAMIC,CHIP;100nF,+80-20%,25V,Y5V,TP,  |          | .....5   | SC42                        | 2402-000179                             | C-AL,SMD;47uF,20%,16V,GP,TP,6.6x6.6x5.4  |
| .....5   | PC06     | 2402-000179                 | C-AL,SMD;47uF,20%,16V,GP,TP,6.6x6.6x5.4   |          | .....5   | SC43                        | 2203-000257                             | C-CERAMIC,CHIP;10nF,10%,50V,X7R,TP,1608  |
| .....5   | PC07     | 2402-001070                 | C-AL,SMD;47uF,20%,16V,GP,TP,10x10,2.-     |          | .....5   | SC44                        | 2402-000179                             | C-AL,SMD;47uF,20%,16V,GP,TP,6.6x6.6x5.4  |
| .....5   | PC08     | 2402-001070                 | C-AL,SMD;47uF,20%,16V,GP,TP,10x10,2.-     |          | .....5   | SC45                        | 2203-000998                             | C-CERAMIC,CHIP;0.047nF,5%,50V,NPO,TP,160 |
| .....5   | PC09     | 2402-001049                 | C-AL,CHIP;10uF,20%,16V,GP,TP,3.3x3.3x5.4  |          | .....5   | SC46                        | 2203-000998                             | C-CERAMIC,CHIP;0.047nF,5%,50V,NPO,TP,160 |
| .....5   | PC10     | 2402-001049                 | C-AL,CHIP;10uF,20%,16V,GP,TP,3.3x3.3x5.4  |          | .....5   | SC47                        | 2402-000179                             | C-AL,SMD;47uF,20%,16V,GP,TP,6.6x6.6x5.4  |
| .....5   | PC11     | 2203-000181                 | C-CERAMIC,CHIP;100nF,+80-20%,25V,Y5V,TP,  |          | .....5   | SC48                        | 2203-000181                             | C-CERAMIC,CHIP;100nF,+80-20%,25V,Y5V,TP, |
| .....5   | PC12     | 2402-001049                 | C-AL,CHIP;10uF,20%,16V,GP,TP,3.3x3.3x5.4  |          | .....5   | SC49                        | 2203-000998                             | C-CERAMIC,CHIP;0.047nF,5%,50V,NPO,TP,160 |
| .....5   | PC13     | 2203-000181                 | C-CERAMIC,CHIP;100nF,+80-20%,25V,Y5V,TP,  |          | .....5   | SC50                        | 2203-000998                             | C-CERAMIC,CHIP;0.047nF,5%,50V,NPO,TP,160 |
| .....5   | PC14     | 2203-000181                 | C-CERAMIC,CHIP;100nF,+80-20%,25V,Y5V,TP,  |          | .....5   | SC51                        | 2203-002494                             | C-CERAMIC,CHIP;470nF,10%,16V,X7R,TP,2012 |
| .....5   | PC15     | 2203-000181                 | C-CERAMIC,CHIP;100nF,+80-20%,25V,Y5V,TP,  |          | .....5   | SC52                        | 2203-002494                             | C-CERAMIC,CHIP;470nF,10%,16V,X7R,TP,2012 |
| .....5   | PC16     | 2203-000181                 | C-CERAMIC,CHIP;100nF,+80-20%,25V,Y5V,TP,  |          | .....5   | SC53                        | 2203-002494                             | C-CERAMIC,CHIP;470nF,10%,16V,X7R,TP,2012 |
| .....5   | PC17     | 2203-000257                 | C-CERAMIC,CHIP;10nF,10%,50V,X7R,TP,1608   |          | .....5   | SC56                        | 2203-000495                             | C-CERAMIC,CHIP;2.2nF,10%,50V,X7R,TP,2012 |
| .....5   | PC18     | 2402-000173                 | C-AL,SMD;4.7uF,20%,35V,GP,TP,4.3x4.3x5.4  |          | .....5   | SC57                        | 2203-000495                             | C-CERAMIC,CHIP;2.2nF,10%,50V,X7R,TP,2012 |
| .....5   | PC19     | 2402-000179                 | C-AL,SMD;47uF,20%,16V,GP,TP,6.6x6.6x5.4   |          | .....5   | SC58                        | 2203-000181                             | C-CERAMIC,CHIP;100nF,+80-20%,25V,Y5V,TP, |
| .....5   | PC20     | 2203-000181                 | C-CERAMIC,CHIP;100nF,+80-20%,25V,Y5V,TP,  |          | .....5   | SL01                        | 3301-001324                             | CORE-FERRITE BEAD;AB,150HM,2X1.25X0.9MM, |
| .....5   | PC21     | 2203-000181                 | C-CERAMIC,CHIP;100nF,+80-20%,25V,Y5V,TP,  |          | .....5   | SL02                        | 3301-001186                             | CORE-FERRITE BEAD;AB,600ohm,3.2x1.6x1.3m |
| .....5   | PC22     | 2402-000179                 | C-AL,SMD;47uF,20%,16V,GP,TP,6.6x6.6x5.4   |          | .....5   | SO01                        | 0501-000280                             | TR-SMALL SIGNAL;KSA1182,PNP,150mW,SOT-23 |
| .....5   | PC23     | 2203-000181                 | C-CERAMIC,CHIP;100nF,+80-20%,25V,Y5V,TP,  |          | .....5   | SR01                        | 2007-000074                             | R-CHIP;100ohm,5%,1/16W,DA,TP,1608        |
| .....5   | PC24     | 2402-000179                 | C-AL,SMD;47uF,20%,16V,GP,TP,6.6x6.6x5.4   |          | .....5   | SR02                        | 2007-000074                             | R-CHIP;100ohm,5%,1/16W,DA,TP,1608        |
| .....5   | PC27     | 2203-000181                 | C-CERAMIC,CHIP;100nF,+80-20%,25V,Y5V,TP,  |          | .....5   | SR03                        | 2007-000074                             | R-CHIP;100ohm,5%,1/16W,DA,TP,1608        |
| .....5   | PC28     | 2402-000179                 | C-AL,SMD;47uF,20%,16V,GP,TP,6.6x6.6x5.4   |          | .....5   | SR04                        | 2007-000074                             | R-CHIP;100ohm,5%,1/16W,DA,TP,1608        |
| .....5   | PC29     | 2203-000181                 | C-CERAMIC,CHIP;100nF,+80-20%,25V,Y5V,TP,  |          | .....5   | SR05                        | 2007-000074                             | R-CHIP;100ohm,5%,1/16W,DA,TP,1608        |
| .....5   | PC30     | 2402-000179                 | C-AL,SMD;47uF,20%,16V,GP,TP,6.6x6.6x5.4   |          | .....5   | SR06                        | 2007-000074                             | R-CHIP;100ohm,5%,1/16W,DA,TP,1608        |
| .....5   | PC31     | 2203-000181                 | C-CERAMIC,CHIP;100nF,+80-20%,25V,Y5V,TP,  |          | .....5   | SR07                        | 2007-000080                             | R-CHIP;2Kohm,5%,1/16W,DA,TP,1608         |
| .....5   | PC32     | 2402-000179                 | C-AL,SMD;47uF,20%,16V,GP,TP,6.6x6.6x5.4   |          | .....5   | SR08                        | 2007-000052                             | R-CHIP;10Kohm,1%,1/16W,DA,TP,1608        |
| .....5   | PCB      | AA41-00610A                 | PCB-DW-SRC;FR-4,4L,A,1.6T,180X245,2A,14   | S.N.A    | .....5   | SR09                        | 2007-000070                             | R-CHIP;0ohm,5%,1/16W,DA,TP,1608          |
| .....5   | PL01     | 3301-001082                 | CORE-FERRITE BEAD;AB,600HM,3.2X2.5X1.3MM  |          | .....5   | SR10                        | 2007-000074                             | R-CHIP;100ohm,5%,1/16W,DA,TP,1608        |
| .....5   | PL02     | 3301-001324                 | CORE-FERRITE BEAD;AB,150HM,2X1.25X0.9MM,  |          | .....5   | SR11                        | 2007-000074                             | R-CHIP;100ohm,5%,1/16W,DA,TP,1608        |
| .....5   | PL03     | 3301-001324                 | CORE-FERRITE BEAD;AB,150HM,2X1.25X0.9MM,  |          | .....5   | SR21                        | 2007-000077                             | R-CHIP;470ohm,5%,1/16W,DA,TP,1608        |
| .....5   | PL04     | 3301-001324                 | CORE-FERRITE BEAD;AB,150HM,2X1.25X0.9MM,  |          | .....5   | SR22                        | 2007-000070                             | R-CHIP;0ohm,5%,1/16W,DA,TP,1608          |
| .....5   | PL05     | 3301-001324                 | CORE-FERRITE BEAD;AB,150HM,2X1.25X0.9MM,  |          | .....5   | SR23                        | 2007-000309                             | R-CHIP;10ohm,5%,1/16W,DA,TP,1608         |
| .....5   | PL06     | 3301-001324                 | CORE-FERRITE BEAD;AB,150HM,2X1.25X0.9MM,  |          | .....5   | SR25                        | 2007-000309                             | R-CHIP;10ohm,5%,1/16W,DA,TP,1608         |
| .....5   | PL07     | 3301-001186                 | CORE-FERRITE BEAD;AB,600ohm,3.2x1.6x1.3m  |          | .....5   | SR26                        | 2007-000309                             | R-CHIP;10ohm,5%,1/16W,DA,TP,1608         |
| .....5   | PL08     | 3301-001186                 | CORE-FERRITE BEAD;AB,600ohm,3.2x1.6x1.3m  |          | .....5   | SR31                        | 2007-000074                             | R-CHIP;100ohm,5%,1/16W,DA,TP,1608        |
| .....5   | PL09     | 3301-001324                 | CORE-FERRITE BEAD;AB,150HM,2X1.25X0.9MM,  |          | .....5   | SR32                        | 2007-000074                             | R-CHIP;100ohm,5%,1/16W,DA,TP,1608        |
| .....5   | PL10     | 3301-001324                 | CORE-FERRITE BEAD;AB,150HM,2X1.25X0.9MM,  |          | .....5   | SR33                        | 2007-000074                             | R-CHIP;100ohm,5%,1/16W,DA,TP,1608        |
| .....5   | PO01     | 0501-000344                 | TR-SMALL SIGNAL;KSC1623-G,NPN,200mW,SOT-  |          | .....5   | SR34                        | 2007-000074                             | R-CHIP;100ohm,5%,1/16W,DA,TP,1608        |
| .....5   | PR01     | 2007-000090                 | R-CHIP;10KOHM,5%,1/16W,DA,TP,1608         |          | .....5   | SR35                        | 2007-000074                             | R-CHIP;100ohm,5%,1/16W,DA,TP,1608        |
| .....5   | PR02     | 2007-000097                 | R-CHIP;47Kohm,5%,1/16W,DA,TP,1608         |          | .....5   | SR36                        | 2007-001166                             | R-CHIP;750HM,5%,1/10W,DA,TP,2012         |
| .....5   | SC01     | 2203-002494                 | C-CERAMIC,CHIP;470nF,10%,16V,X7R,TP,2012  |          | .....5   | SR37                        | 2007-001166                             | R-CHIP;750HM,5%,1/10W,DA,TP,2012         |
| .....5   | SC02     | 2203-002494                 | C-CERAMIC,CHIP;470nF,10%,16V,X7R,TP,2012  |          | .....5   | SR38                        | 2007-001166                             | R-CHIP;750HM,5%,1/10W,DA,TP,2012         |
| .....5   | SC03     | 2203-002494                 | C-CERAMIC,CHIP;470nF,10%,16V,X7R,TP,2012  |          | .....5   | SR39                        | 2007-001166                             | R-CHIP;750HM,5%,1/10W,DA,TP,2012         |
| .....5   | SC04     | 2203-002494                 | C-CERAMIC,CHIP;470nF,10%,16V,X7R,TP,2012  |          | .....5   | SR40                        | 2007-001166                             | R-CHIP;750HM,5%,1/10W,DA,TP,2012         |
| .....5   | SC05     | 2203-002494                 | C-CERAMIC,CHIP;470nF,10%,16V,X7R,TP,2012  |          | .....5   | SR47                        | 2007-000074                             | R-CHIP;100ohm,5%,1/16W,DA,TP,1608        |
| .....5   | SC06     | 2203-002494                 | C-CERAMIC,CHIP;470nF,10%,16V,X7R,TP,2012  |          | .....5   | SR48                        | 2007-000074                             | R-CHIP;100ohm,5%,1/16W,DA,TP,1608        |
| .....5   | SC07     | 2203-002494                 | C-CERAMIC,CHIP;470nF,10%,16V,X7R,TP,2012  |          | .....5   | SR49                        | 2007-000074                             | R-CHIP;100ohm,5%,1/16W,DA,TP,1608        |
| .....5   | SC08     | 2203-002494                 | C-CERAMIC,CHIP;470nF,10%,16V,X7R,TP,2012  |          | .....5   | SR53                        | 2007-000074                             | R-CHIP;100ohm,5%,1/16W,DA,TP,1608        |
| .....5   | SC09     | 2203-002494                 | C-CERAMIC,CHIP;470nF,10%,16V,X7R,TP,2012  |          | .....5   | SR73                        | 2007-000258                             | R-CHIP;1.6KOHM,5%,1/10W,DA,TP,2012       |
| .....5   | SC10     | 2203-002494                 | C-CERAMIC,CHIP;470nF,10%,16V,X7R,TP,2012  |          | .....5   | SR74                        | 2007-000077                             | R-CHIP;470ohm,5%,1/16W,DA,TP,1608        |
| .....5   | SC11     | 2402-000179                 | C-AL,SMD;47uF,20%,16V,GP,TP,6.6x6.6x5.4   |          | .....5   | SR75                        | 2007-000290                             | R-CHIP;100OHM,5%,1/10W,DA,TP,2012        |
| .....5   | SC12     | 2203-000181                 | C-CERAMIC,CHIP;100nF,+80-20%,25V,Y5V,TP,  |          | .....5   | YR43                        | 2007-000074                             | R-CHIP;100ohm,5%,1/16W,DA,TP,1608        |
| .....5   | SC13     | 2203-000257                 | C-CERAMIC,CHIP;10nF,10%,50V,X7R,TP,1608   |          | .....5   | YR44                        | 2007-000074                             | R-CHIP;100ohm,5%,1/16W,DA,TP,1608        |
| .....5   | SC14     | 2203-005809                 | C-CERAMIC,CHIP;1000nF,10%,16V,X7R,TP,201  |          | .....5   | YR45                        | 2007-000074                             | R-CHIP;100ohm,5%,1/16W,DA,TP,1608        |
| .....5   | SC15     | 2203-000181                 | C-CERAMIC,CHIP;100nF,+80-20%,25V,Y5V,TP,  |          | .....3   | 0202-000187                 | SOLDER-WIRE FLUX;-RS60S,D1.2,63Sn/37Pb  | S.N.A                                    |
| .....5   | SC16     | 2402-000179                 | C-AL,SMD;47uF,20%,16V,GP,TP,6.6x6.6x5.4   |          | .....3   | BP97-00024A                 | ASSY ROBOT;HCM422WX/XAA,P55A,ROBOT,P55A |  |
| .....5   | SC17     | 2203-000181                 | C-CERAMIC,CHIP;100nF,+80-20%,25V,Y5V,TP,  |          | .....4   | CN801                       | 3711-003975                             | CONNECTOR-HEADER;BOX,14P,1R,2.5mm,STRAIG |
| .....5   | SC18     | 2402-000179                 | C-AL,SMD;47uF,20%,16V,GP,TP,6.6x6.6x5.4   |          | .....4   | CN802                       | 3711-004946                             | CONNECTOR-HEADER;BOX,15P,1R,2.5MM,STRAIG |
| .....5   | SC19     | 2203-000181                 | C-CERAMIC,CHIP;100nF,+80-20%,25V,Y5V,TP,  |          | .....4   | CN902                       | 3711-003973                             | CONNECTOR-HEADER;BOX,11P,1R,2.5mm,STRAIG |
| .....5   | SC20     | 2203-002494                 | C-CERAMIC,CHIP;470nF,10%,16V,X7R,TP,2012  |          | .....4   | CNY01                       | 3711-003641                             | CONNECTOR-HEADER;BOX,12P,1R,2.5mm,STRAIG |
| .....5   | SC21     | 2203-002494                 | C-CERAMIC,CHIP;470nF,10%,16V,X7R,TP,2012  |          | .....4   | CNZ02                       | 3711-003046                             | CONNECTOR-HEADER;BOX,9P,1R,2.5mm,STRAIG  |
| .....5   | SC22     | 2203-002494                 | C-CERAMIC,CHIP;470nF,10%,16V,X7R,TP,2012  |          | .....4   | IC807                       | 1203-000165                             | IC-POSJ.ADJUST REG.;78R12,TO-220,4P,-,PL |
| .....5   | SC23     | 2203-002494                 | C-CERAMIC,CHIP;470nF,10%,16V,X7R,TP,2012  |          | .....4   | TU02                        | AA40-00041A                             | TUNER-F/S;TCPN3081PC09C(S),NTSC,181CH,45 |
| .....5   | SC24     | 2203-002494                 | C-CERAMIC,CHIP;470nF,10%,16V,X7R,TP,2012  |          | .....4   | TU04                        | AA40-00041A                             | TUNER-F/S;TCPN3081PC09C(S),NTSC,181CH,45 |
| .....5   | SC25     | 2203-002494                 | C-CERAMIC,CHIP;470nF,10%,16V,X7R,TP,2012  |          | .....4   | BP97-00083A                 | ASSY AUTO;HCM422WX/XAA,P55A,AUTO,P55A   |  |

Electrical Parts List

| Loc. No. | Code No. | Description ; Specification                          | Remark | Loc. No. | Code No. | Description ; Specification                          | Remark |
|----------|----------|--|--------|----------|----------|--|--------|
| ....5    | C102     | 2401-000302 C-AL;100uF,20%,25V,GP,TP,6.3x11,5        |        | ....5    | C823     | 2401-002463 C-AL;470uF,20%,16V,GP,TP,8x11.5,5        |        |
| ....5    | C104     | 2401-000039 C-AL;1000uF,20%,16V,GP,TP,10x16,5        |        | ....5    | C826     | 2401-002619 C-AL;47uF,20%,25V,GP,TP,5x11,5           |        |
| ....5    | C106     | 2401-001513 C-AL;47uF,20%,16V,WT,TP,5x11,5           |        | ....5    | C827     | 2401-000832 C-AL;220uF,20%,25V,GP,TP,8x11.5,5        |        |
| ....5    | C108     | 2401-000603 C-AL;1uF,20%,50V,GP,TP,5x11,5            |        | ....5    | C830     | 2401-001397 C-AL;470uF,20%,25V,GP,TP,10x16,5         |        |
| ....5    | C111     | 2401-002463 C-AL;470uF,20%,16V,GP,TP,8x11.5,5        |        | ....5    | C831     | 2401-002300 C-AL;47uF,20%,50V,GP,TP,6.3x11,5         |        |
| ....5    | C113     | 2401-000603 C-AL;1uF,20%,50V,GP,TP,5x11,5            |        | ....5    | C832     | 2401-000039 C-AL;1000uF,20%,16V,GP,TP,10x16,5        |        |
| ....5    | C124     | 2401-000962 C-AL;22uF,20%,50V,GP,TP,5x11,5           |        | ....5    | C834     | 2401-002594 C-AL;220uF,20%,16V,GP,TP,8x11.5,5        |        |
| ....5    | C125     | 2401-000962 C-AL;22uF,20%,50V,GP,TP,5x11,5           |        | ....5    | C901     | 2401-002619 C-AL;47uF,20%,25V,GP,TP,5x11,5           |        |
| ....5    | C134     | 2401-000962 C-AL;22uF,20%,50V,GP,TP,5x11,5           |        | ....5    | C903     | 2401-002619 C-AL;47uF,20%,25V,GP,TP,5x11,5           |        |
| ....5    | C135     | 2401-000962 C-AL;22uF,20%,50V,GP,TP,5x11,5           |        | ....5    | CN101    | 3711-002642 CONNECTOR-HEADER;BOX,3P,1R,2.5mm,STRAIGH |        |
| ....5    | C136     | 2401-000962 C-AL;22uF,20%,50V,GP,TP,5x11,5           |        | ....5    | CN201    | 3711-002645 CONNECTOR-HEADER;BOX,6P,1R,2.5mm,STRAIGH |        |
| ....5    | C137     | 2401-000962 C-AL;22uF,20%,50V,GP,TP,5x11,5           |        | ....5    | CN601    | 3711-002643 CONNECTOR-HEADER;BOX,4P,1R,2.5mm,STRAIGH |        |
| ....5    | C138     | 2401-000962 C-AL;22uF,20%,50V,GP,TP,5x11,5           |        | ....5    | CN903    | 3711-002642 CONNECTOR-HEADER;BOX,3P,1R,2.5mm,STRAIGH |        |
| ....5    | C139     | 2401-000962 C-AL;22uF,20%,50V,GP,TP,5x11,5           |        | ....5    | D601     | 0401-000005 DIODE-SWITCHING;1N4148,100V,200mA,DO-35, |        |
| ....5    | C147     | 2401-000480 C-AL;10uF,20%,50V,GP,TP,5x11,5           |        | ....5    | D604     | 0401-000005 DIODE-SWITCHING;1N4148,100V,200mA,DO-35, |        |
| ....5    | C601     | 2401-000480 C-AL;10uF,20%,50V,GP,TP,5x11,5           |        | ....5    | D605     | 0401-000005 DIODE-SWITCHING;1N4148,100V,200mA,DO-35, |        |
| ....5    | C604     | 2401-000480 C-AL;10uF,20%,50V,GP,TP,5x11,5           |        | ....5    | D606     | 0402-000546 DIODE-RECTIFIER;TVR10G,400V,1.0A,DO-41,T |        |
| ....5    | C607     | 2401-000962 C-AL;22uF,20%,50V,GP,TP,5x11,5           |        | ....5    | D607     | 0401-000005 DIODE-SWITCHING;1N4148,100V,200mA,DO-35, |        |
| ....5    | C609     | 2401-000962 C-AL;22uF,20%,50V,GP,TP,5x11,5           |        | ....5    | D608     | 0401-000005 DIODE-SWITCHING;1N4148,100V,200mA,DO-35, |        |
| ....5    | C610     | 2401-000302 C-AL;100uF,20%,25V,GP,TP,6.3x11,5        |        | ....5    | D609     | 0401-000005 DIODE-SWITCHING;1N4148,100V,200mA,DO-35, |        |
| ....5    | C612     | 2401-000962 C-AL;22uF,20%,50V,GP,TP,5x11,5           |        | ....5    | DZ605    | 0403-001039 DIODE-ZENER;MA2560,56V,52-60V,1W,DO-41,T |        |
| ....5    | C617     | 2401-000962 C-AL;22uF,20%,50V,GP,TP,5x11,5           |        | ....5    | DZ606    | 0403-001325 DIODE-ZENER;MTZJ15C,14.35-15.09V,500mW,D |        |
| ....5    | C620     | 2401-000360 C-AL;100uF,20%,50V,GP,TP,8x11.5,5        |        | ....5    | DZ607    | 0403-001319 DIODE-ZENER;MTZJ4.7C,4.68-4.93V,500mW,DO |        |
| ....5    | C629     | 2401-000962 C-AL;22uF,20%,50V,GP,TP,5x11,5           |        | ....5    | DZ801    | 0403-000700 DIODE-ZENER;TZP33A,33V,31-35V,1W,DO-41,T |        |
| ....5    | C630     | 2401-000962 C-AL;22uF,20%,50V,GP,TP,5x11,5           |        | ....5    | GT01     | AA60-40014A PIN-GT,ASSY;1P,-,AUTO                    | S.N.A  |
| ....5    | C631     | 2401-000480 C-AL;10uF,20%,50V,GP,TP,5x11,5           |        | ....5    | GT02     | AA60-40014A PIN-GT,ASSY;1P,-,AUTO                    | S.N.A  |
| ....5    | C632     | 2401-000480 C-AL;10uF,20%,50V,GP,TP,5x11,5           |        | ....5    | GT03     | AA60-40014A PIN-GT,ASSY;1P,-,AUTO                    | S.N.A  |
| ....5    | C633     | 2401-000480 C-AL;10uF,20%,50V,GP,TP,5x11,5           |        | ....5    | L101     | 2701-000115 INDUCTOR-AXIAL;10uH,10%,3x7mm            |        |
| ....5    | C639     | 2401-000962 C-AL;22uF,20%,50V,GP,TP,5x11,5           |        | ....5    | L102     | 2701-001040 INDUCTOR-AXIAL;10uH,10%,4.5x14mm         |        |
| ....5    | C640     | 2401-000962 C-AL;22uF,20%,50V,GP,TP,5x11,5           |        | ....5    | L103     | 2701-000115 INDUCTOR-AXIAL;10uH,10%,3x7mm            |        |
| ....5    | C642     | 2401-000027 C-AL;4.7uF,20%,50V,GP,TP,5x11,5          |        | ....5    | L104     | 2701-000115 INDUCTOR-AXIAL;10uH,10%,3x7mm            |        |
| ....5    | C643     | 2401-000027 C-AL;4.7uF,20%,50V,GP,TP,5x11,5          |        | ....5    | L105     | 2701-000106 INDUCTOR-AXIAL;1.5uH,10%,3x7mm           |        |
| ....5    | C644     | 2401-000027 C-AL;4.7uF,20%,50V,GP,TP,5x11,5          |        | ....5    | L106     | 2701-000115 INDUCTOR-AXIAL;10uH,10%,3x7mm            |        |
| ....5    | C645     | 2401-001989 C-AL;4.7uF,20%,50V,BP,TP,5x11,5          |        | ....5    | L107     | 2701-000114 INDUCTOR-AXIAL;10uH,10%,2.5x3.4mm        |        |
| ....5    | C646     | 2401-001989 C-AL;4.7uF,20%,50V,BP,TP,5x11,5          |        | ....5    | L108     | 2701-000114 INDUCTOR-AXIAL;10uH,10%,2.5x3.4mm        |        |
| ....5    | C647     | 2401-001989 C-AL;4.7uF,20%,50V,BP,TP,5x11,5          |        | ....5    | L111     | 2701-000114 INDUCTOR-AXIAL;10uH,10%,2.5x3.4mm        |        |
| ....5    | C648     | 2401-001989 C-AL;4.7uF,20%,50V,BP,TP,5x11,5          |        | ....5    | L112     | 2701-000114 INDUCTOR-AXIAL;10uH,10%,2.5x3.4mm        |        |
| ....5    | C649     | 2401-001989 C-AL;4.7uF,20%,50V,BP,TP,5x11,5          |        | ....5    | L113     | 2701-000114 INDUCTOR-AXIAL;10uH,10%,2.5x3.4mm        |        |
| ....5    | C650     | 2401-001989 C-AL;4.7uF,20%,50V,BP,TP,5x11,5          |        | ....5    | L114     | 2701-000114 INDUCTOR-AXIAL;10uH,10%,2.5x3.4mm        |        |
| ....5    | C652     | 2401-000480 C-AL;10uF,20%,50V,GP,TP,5x11,5           |        | ....5    | L119     | 2701-000114 INDUCTOR-AXIAL;10uH,10%,2.5x3.4mm        |        |
| ....5    | C656     | 2401-000480 C-AL;10uF,20%,50V,GP,TP,5x11,5           |        | ....5    | L120     | 2701-000114 INDUCTOR-AXIAL;10uH,10%,2.5x3.4mm        |        |
| ....5    | C662     | 2401-002619 C-AL;47uF,20%,25V,GP,TP,5x11,5           |        | ....5    | L121     | 2701-000114 INDUCTOR-AXIAL;10uH,10%,2.5x3.4mm        |        |
| ....5    | C664     | 2401-000480 C-AL;10uF,20%,50V,GP,TP,5x11,5           |        | ....5    | L122     | 2701-000114 INDUCTOR-AXIAL;10uH,10%,2.5x3.4mm        |        |
| ....5    | C668     | 2401-000480 C-AL;10uF,20%,50V,GP,TP,5x11,5           |        | ....5    | L123     | 2701-000114 INDUCTOR-AXIAL;10uH,10%,2.5x3.4mm        |        |
| ....5    | C669     | 2401-000480 C-AL;10uF,20%,50V,GP,TP,5x11,5           |        | ....5    | L124     | 2701-000114 INDUCTOR-AXIAL;10uH,10%,2.5x3.4mm        |        |
| ....5    | C670     | 2401-000480 C-AL;10uF,20%,50V,GP,TP,5x11,5           |        | ....5    | L605     | 3301-000287 CORE-FERRITE BEAD;AA,3.5x1.0x6.0mm,1500, |        |
| ....5    | C674     | 2401-000480 C-AL;10uF,20%,50V,GP,TP,5x11,5           |        | ....5    | L606     | 3301-000287 CORE-FERRITE BEAD;AA,3.5x1.0x6.0mm,1500, |        |
| ....5    | C675     | 2401-000480 C-AL;10uF,20%,50V,GP,TP,5x11,5           |        | ....5    | L703     | 2701-000115 INDUCTOR-AXIAL;10uH,10%,3x7mm            |        |
| ....5    | C676     | 2401-000480 C-AL;10uF,20%,50V,GP,TP,5x11,5           |        | ....5    | L705     | 2701-001030 INDUCTOR-AXIAL;43uH,10%,5x14mm           |        |
| ....5    | C679     | 2401-000603 C-AL;1uF,20%,50V,GP,TP,5x11,5            |        | ....5    | L706     | 2701-001030 INDUCTOR-AXIAL;43uH,10%,5x14mm           |        |
| ....5    | C680     | 2401-000603 C-AL;1uF,20%,50V,GP,TP,5x11,5            |        | ....5    | O601     | 0501-000389 TR-SMALL SIGNAL;KSC815,NPN,400mW,TO-92,T |        |
| ....5    | C682     | 2305-000665 C-FILM,MPEF;100nF,5%,63V,TP,7.5x4.0x5.0m |        | ....5    | O602     | 0501-000389 TR-SMALL SIGNAL;KSC815,NPN,400mW,TO-92,T |        |
| ....5    | C683     | 2401-000962 C-AL;22uF,20%,50V,GP,TP,5x11,5           |        | ....5    | O603     | 0501-000389 TR-SMALL SIGNAL;KSC815,NPN,400mW,TO-92,T |        |
| ....5    | C684     | 2401-000603 C-AL;1uF,20%,50V,GP,TP,5x11,5            |        | ....5    | R658     | 2001-000812 R-CARBON;5.6KOHM,5%,1/8W,AA,TP,1.8X3.2MM |        |
| ....5    | C685     | 2401-001192 C-AL;33uF,20%,50V,GP,TP,6.3x11,5         |        | ....5    | R659     | 2001-000734 R-CARBON;4.7KOHM,5%,1/8W,AA,TP,1.8X3.2MM |        |
| ....5    | C686     | 2401-000192 C-AL;1000uF,20%,50V,GP,TP,16x25,7.5      |        | ....5    | R660     | 2001-000734 R-CARBON;4.7KOHM,5%,1/8W,AA,TP,1.8X3.2MM |        |
| ....5    | C687     | 2305-000665 C-FILM,MPEF;100nF,5%,63V,TP,7.5x4.0x5.0m |        | ....5    | R661     | 2001-000734 R-CARBON;4.7KOHM,5%,1/8W,AA,TP,1.8X3.2MM |        |
| ....5    | C688     | 2401-000192 C-AL;1000uF,20%,50V,GP,TP,16x25,7.5      |        | ....5    | R662     | 2001-000660 R-CARBON;33KOHM,5%,1/8W,AA,TP,1.8X3.2MM  |        |
| ....5    | C689     | 2305-000665 C-FILM,MPEF;100nF,5%,63V,TP,7.5x4.0x5.0m |        | ....5    | R663     | 2001-000007 R-CARBON;3KOHM,5%,1/8W,AA,TP,1.8X3.2MM   |        |
| ....5    | C690     | 2401-000027 C-AL;4.7uF,20%,50V,GP,TP,5x11,5          |        | ....5    | R664     | 2001-000780 R-CARBON;470OHM,5%,1/8W,AA,TP,1.8X3.2MM  |        |
| ....5    | C691     | 2401-002300 C-AL;47uF,20%,50V,GP,TP,6.3x11,5         |        | ....5    | R665     | 2001-000273 R-CARBON;100KOHM,5%,1/8W,AA,TP,1.8X3.2MM |        |
| ....5    | C694     | 2301-000192 C-FILM,PEF;1nF,5%,50V,TP,5.3x10mm,5mm    |        | ....5    | R666     | 2001-000780 R-CARBON;470OHM,5%,1/8W,AA,TP,1.8X3.2MM  |        |
| ....5    | C695     | 2301-000192 C-FILM,PEF;1nF,5%,50V,TP,5.3x10mm,5mm    |        | ....5    | R667     | 2001-000290 R-CARBON;10KOHM,5%,1/8W,AA,TP,1.8X3.2MM  |        |
| ....5    | C706     | 2401-002619 C-AL;47uF,20%,25V,GP,TP,5x11,5           |        | ....5    | R668     | 2001-000290 R-CARBON;10KOHM,5%,1/8W,AA,TP,1.8X3.2MM  |        |
| ....5    | C716     | 2401-001840 C-AL;100uF,20%,16V,GP,TP,6.3x11,5        |        | ....5    | R669     | 2001-000290 R-CARBON;10KOHM,5%,1/8W,AA,TP,1.8X3.2MM  |        |
| ....5    | C720     | 2401-002144 C-AL;47uF,20%,16V,GP,TP,5x11,5           |        | ....5    | R670     | 2001-000411 R-CARBON;18KOHM,5%,1/8W,AA,TP,1.8X3.2MM  |        |
| ....5    | C802     | 2401-000471 C-AL;10uF,20%,50V,BP,TP,5x11,5mm         |        | ....5    | R671     | 2001-000734 R-CARBON;4.7KOHM,5%,1/8W,AA,TP,1.8X3.2MM |        |
| ....5    | C803     | 2401-001840 C-AL;100uF,20%,16V,GP,TP,6.3x11,5        |        | ....5    | R672     | 2001-000812 R-CARBON;5.6KOHM,5%,1/8W,AA,TP,1.8X3.2MM |        |
| ....5    | C806     | 2401-000360 C-AL;100uF,20%,50V,GP,TP,8x11.5,5        |        | ....5    | R673     | 2004-001970 R-METAL(S);1.8Kohm,1%,1/2W,AA,TP,6.5x2.5 |        |
| ....5    | C808     | 2401-002459 C-AL;220uF,20%,25V,LZ,TP,10x16,5         |        | ....5    | R674     | 2001-001103 R-CARBON(S);20KOHM,5%,1/2W,AA,TP,2.4X6.4 |        |
| ....5    | C809     | 2401-002459 C-AL;220uF,20%,25V,LZ,TP,10x16,5         |        | ....5    | R675     | 2004-001390 R-METAL(S);1Kohm,2%,1/2W,AA,TP,2.4x6.4mm |        |
| ....5    | C812     | 2401-002459 C-AL;220uF,20%,25V,LZ,TP,10x16,5         |        | ....5    | R676     | 2004-001390 R-METAL(S);1Kohm,2%,1/2W,AA,TP,2.4x6.4mm |        |
| ....5    | C813     | 2401-002459 C-AL;220uF,20%,25V,LZ,TP,10x16,5         |        | ....5    | R677     | 2001-001103 R-CARBON(S);20KOHM,5%,1/2W,AA,TP,2.4X6.4 |        |
| ....5    | C816     | 2401-002459 C-AL;220uF,20%,25V,LZ,TP,10x16,5         |        | ....5    | R678     | 2004-001970 R-METAL(S);1.8Kohm,1%,1/2W,AA,TP,6.5x2.5 |        |
| ....5    | C817     | 2401-002459 C-AL;220uF,20%,25V,LZ,TP,10x16,5         |        | ....5    | R679     | 2004-001970 R-METAL(S);1.8Kohm,1%,1/2W,AA,TP,6.5x2.5 |        |
| ....5    | C819     | 2401-001840 C-AL;100uF,20%,16V,GP,TP,6.3x11,5        |        | ....5    | R680     | 2004-001970 R-METAL(S);1.8Kohm,1%,1/2W,AA,TP,6.5x2.5 |        |
| ....5    | C822     | 2401-001840 C-AL;100uF,20%,16V,GP,TP,6.3x11,5        |        | ....5    | R681     | 2001-001146 R-CARBON(S);4.7OHM,5%,1/2W,AA,TP,2.4X6.4 |        |

| Loc. No. | Code No. | Description ; Specification | Remark                                     | Loc. No. | Code No. | Description ; Specification | Remark                                       |
|----------|----------|-----------------------------|--|----------|----------|-----------------------------|--|
| .....5   | R682     | 2001-001146                 | R-CARBON(S);4.70HM,5%,1/2W,AA,TP,2.4X6.4   | .....6   | C715     | 2203-001652                 | C-CERAMIC,CHIP;470nF,+80-20%,16V,Y5V,TP,     |
| .....5   | R683     | 2001-000290                 | R-CARBON;10KOHM,5%,1/8W,AA,TP,1.8X3.2MM    | .....6   | C717     | 2203-000260                 | C-CERAMIC,CHIP;10nF,10%,50V,X7R,TP,2012      |
| .....5   | R685     | 2001-001000                 | R-CARBON;82KOHM,5%,1/8W,AA,TP,1.8X3.2MM    | .....6   | C721     | 2203-000189                 | C-CERAMIC,CHIP;100nF,+80-20%,25V,Y5V,TP,     |
| .....5   | R686     | 2001-000331                 | R-CARBON;12KOHM,5%,1/8W,AA,TP,1.8X3.2MM    | .....6   | C722     | 2203-000189                 | C-CERAMIC,CHIP;100nF,+80-20%,25V,Y5V,TP,     |
| .....5   | R687     | 2001-000812                 | R-CARBON;5.6KOHM,5%,1/8W,AA,TP,1.8X3.2MM   | .....6   | C804     | 2203-000189                 | C-CERAMIC,CHIP;100nF,+80-20%,25V,Y5V,TP,     |
| .....5   | R801     | 2001-001077                 | R-CARBON(S);1500HM,5%,1/2W,AA,TP,2.4X6.4   | .....6   | C805     | 2203-000189                 | C-CERAMIC,CHIP;100nF,+80-20%,25V,Y5V,TP,     |
| .....5   | R802     | 2001-000739                 | R-CARBON;4.7MOHM,5%,1/8W,AA,TP,1.8X3.2MM   | .....6   | C807     | 2203-000189                 | C-CERAMIC,CHIP;100nF,+80-20%,25V,Y5V,TP,     |
| .....5   | R803     | 2001-000739                 | R-CARBON;4.7MOHM,5%,1/8W,AA,TP,1.8X3.2MM   | .....6   | C810     | 2203-000189                 | C-CERAMIC,CHIP;100nF,+80-20%,25V,Y5V,TP,     |
| .....5   | R804     | 2001-000739                 | R-CARBON;4.7MOHM,5%,1/8W,AA,TP,1.8X3.2MM   | .....6   | C811     | 2203-000189                 | C-CERAMIC,CHIP;100nF,+80-20%,25V,Y5V,TP,     |
| .....5   | R805     | 2001-000037                 | R-CARBON(S);330OHM,5%,1/2W,AA,TP,2.4X6.4   | .....6   | C814     | 2203-000189                 | C-CERAMIC,CHIP;100nF,+80-20%,25V,Y5V,TP,     |
| .....5   | R806     | 2001-000739                 | R-CARBON;4.7MOHM,5%,1/8W,AA,TP,1.8X3.2MM   | .....6   | C815     | 2203-000189                 | C-CERAMIC,CHIP;100nF,+80-20%,25V,Y5V,TP,     |
| .....5   | R808     | 2001-000066                 | R-CARBON(S);10KOHM,5%,1/2W,AA,TP,2.4X6.4   | .....6   | C818     | 2203-000189                 | C-CERAMIC,CHIP;100nF,+80-20%,25V,Y5V,TP,     |
| .....5   | R809     | 2001-000739                 | R-CARBON;4.7MOHM,5%,1/8W,AA,TP,1.8X3.2MM   | .....6   | C820     | 2203-000181                 | C-CERAMIC,CHIP;100nF,+80-20%,25V,Y5V,TP,     |
| .....5   | R810     | 2001-000066                 | R-CARBON(S);10KOHM,5%,1/2W,AA,TP,2.4X6.4   | .....6   | C821     | 2203-000181                 | C-CERAMIC,CHIP;100nF,+80-20%,25V,Y5V,TP,     |
| .....5   | R811     | 2001-001182                 | R-CARBON(S);7.5KOHM,5%,1/2W,AA,TP,2.4X6.4  | .....6   | C824     | 2203-000181                 | C-CERAMIC,CHIP;100nF,+80-20%,25V,Y5V,TP,     |
| .....5   | R812     | 2001-000577                 | R-CARBON;2KOHM,5%,1/8W,AA,TP,1.8X3.2MM     | .....6   | C825     | 2203-000181                 | C-CERAMIC,CHIP;100nF,+80-20%,25V,Y5V,TP,     |
| .....5   | R813     | 2001-000508                 | R-CARBON;220KOHM,5%,1/8W,AA,TP,1.8X3.2MM   | .....6   | C828     | 2203-000181                 | C-CERAMIC,CHIP;100nF,+80-20%,25V,Y5V,TP,     |
| .....5   | R814     | 2003-001098                 | R-METAL OXIDE(S);22Kohm,5%,3W,AA,TP,6x16   | .....6   | C829     | 2203-000181                 | C-CERAMIC,CHIP;100nF,+80-20%,25V,Y5V,TP,     |
| .....5   | X601     | 2801-003903                 | CRYSTAL-UNIT;18.432MHz,25ppm,28-AA,TP,12pF | .....6   | C833     | 2203-000189                 | C-CERAMIC,CHIP;100nF,+80-20%,25V,Y5V,TP,     |
| .....5   |          | BP97-00097A                 | ASSY SMD;HCM422VWX/AAA,P55A,SMD,P55A       | .....6   | C835     | 2203-000189                 | C-CERAMIC,CHIP;100nF,+80-20%,25V,Y5V,TP,     |
| .....6   | C101     | 2203-000260                 | C-CERAMIC,CHIP;10nF,10%,50V,X7R,TP,2012    | .....6   | C902     | 2203-000189                 | C-CERAMIC,CHIP;100nF,+80-20%,25V,Y5V,TP,     |
| .....6   | C105     | 2203-000260                 | C-CERAMIC,CHIP;10nF,10%,50V,X7R,TP,2012    | .....6   | C904     | 2203-000189                 | C-CERAMIC,CHIP;100nF,+80-20%,25V,Y5V,TP,     |
| .....6   | C107     | 2203-000260                 | C-CERAMIC,CHIP;10nF,10%,50V,X7R,TP,2012    | .....6   | DZ102    | 0403-000314                 | DIODE-ZENER;RLZJ9.1B,9.1V,8.80-9.30V,400     |
| .....6   | C109     | 2203-000260                 | C-CERAMIC,CHIP;10nF,10%,50V,X7R,TP,2012    | .....6   | DZ103    | 0403-000314                 | DIODE-ZENER;RLZJ9.1B,9.1V,8.80-9.30V,400     |
| .....6   | C110     | 2203-000260                 | C-CERAMIC,CHIP;10nF,10%,50V,X7R,TP,2012    | .....6   | DZ104    | 0403-000314                 | DIODE-ZENER;RLZJ9.1B,9.1V,8.80-9.30V,400     |
| .....6   | C112     | 2203-000260                 | C-CERAMIC,CHIP;10nF,10%,50V,X7R,TP,2012    | .....6   | DZ105    | 0403-000314                 | DIODE-ZENER;RLZJ9.1B,9.1V,8.80-9.30V,400     |
| .....6   | C114     | 2203-000236                 | C-CERAMIC,CHIP;0.1nF,5%,50V,NPO,TP,1608    | .....6   | DZ106    | 0403-000314                 | DIODE-ZENER;RLZJ9.1B,9.1V,8.80-9.30V,400     |
| .....6   | C115     | 2203-000236                 | C-CERAMIC,CHIP;0.1nF,5%,50V,NPO,TP,1608    | .....6   | DZ107    | 0403-000314                 | DIODE-ZENER;RLZJ9.1B,9.1V,8.80-9.30V,400     |
| .....6   | C116     | 2203-000236                 | C-CERAMIC,CHIP;0.1nF,5%,50V,NPO,TP,1608    | .....6   | DZ108    | 0403-000314                 | DIODE-ZENER;RLZJ9.1B,9.1V,8.80-9.30V,400     |
| .....6   | C117     | 2203-000236                 | C-CERAMIC,CHIP;0.1nF,5%,50V,NPO,TP,1608    | .....6   | DZ109    | 0403-000314                 | DIODE-ZENER;RLZJ9.1B,9.1V,8.80-9.30V,400     |
| .....6   | C120     | 2203-000236                 | C-CERAMIC,CHIP;0.1nF,5%,50V,NPO,TP,1608    | .....6   | DZ601    | 0403-001016                 | DIODE-ZENER;RLZ6.2B,6.2V,5.96-6.27V,400m     |
| .....6   | C121     | 2203-000236                 | C-CERAMIC,CHIP;0.1nF,5%,50V,NPO,TP,1608    | .....6   | DZ602    | 0403-001117                 | DIODE-ZENER;RLZ12B.5%,500mW,LL-34,TP         |
| .....6   | C126     | 2203-000236                 | C-CERAMIC,CHIP;0.1nF,5%,50V,NPO,TP,1608    | .....6   | DZ603    | 0403-001016                 | DIODE-ZENER;RLZ6.2B,6.2V,5.96-6.27V,400m     |
| .....6   | C127     | 2203-000236                 | C-CERAMIC,CHIP;0.1nF,5%,50V,NPO,TP,1608    | .....6   | DZ604    | 0403-001117                 | DIODE-ZENER;RLZ12B.5%,500mW,LL-34,TP         |
| .....6   | C140     | 2203-000236                 | C-CERAMIC,CHIP;0.1nF,5%,50V,NPO,TP,1608    | .....6   | DZ701    | 0403-000314                 | DIODE-ZENER;RLZJ9.1B,9.1V,8.80-9.30V,400     |
| .....6   | C141     | 2203-000236                 | C-CERAMIC,CHIP;0.1nF,5%,50V,NPO,TP,1608    | .....6   | DZ702    | 0403-001016                 | DIODE-ZENER;RLZ6.2B,6.2V,5.96-6.27V,400m     |
| .....6   | C142     | 2203-000236                 | C-CERAMIC,CHIP;0.1nF,5%,50V,NPO,TP,1608    | .....6   | DZ703    | 0403-001016                 | DIODE-ZENER;RLZ6.2B,6.2V,5.96-6.27V,400m     |
| .....6   | C143     | 2203-000236                 | C-CERAMIC,CHIP;0.1nF,5%,50V,NPO,TP,1608    | .....6   | DZ704    | 0403-000314                 | DIODE-ZENER;RLZJ9.1B,9.1V,8.80-9.30V,400     |
| .....6   | C145     | 2203-000236                 | C-CERAMIC,CHIP;0.1nF,5%,50V,NPO,TP,1608    | .....6   | DZ705    | 0403-001117                 | DIODE-ZENER;RLZ12B.5%,500mW,LL-34,TP         |
| .....6   | C146     | 2203-000236                 | C-CERAMIC,CHIP;0.1nF,5%,50V,NPO,TP,1608    | .....6   | DZ707    | 0403-001016                 | DIODE-ZENER;RLZ6.2B,6.2V,5.96-6.27V,400m     |
| .....6   | C602     | 2203-000189                 | C-CERAMIC,CHIP;100nF,+80-20%,25V,Y5V,TP,   | .....6   | IC602    | 1204-002002                 | IC-SOUND PROCESSOR;MSP3420G-B11,POFF,80P     |
| .....6   | C603     | 2203-005590                 | C-CERAMIC,CHIP;330NF,10%,16V,X7R,TP,2012   | .....6   | IC603    | 1201-000541                 | IC-OP AMP;062,SOP8P;153ML,DUAL,6V/mV,IP      |
| .....6   | C605     | 2203-000440                 | C-CERAMIC,CHIP;1nF,10%,50V,X7R,TP,1608,-   | .....6   | IC605    | 1001-001178                 | IC-AUDIO SWITCH;TEA6422,AUDIO SWITCH ,S      |
| .....6   | C606     | 2203-000440                 | C-CERAMIC,CHIP;1nF,10%,50V,X7R,TP,1608,-   | .....6   | IC701    | 1001-001177                 | IC-VIDEO SWITCH;TEA6425D,VIDEO SWITCH ,S     |
| .....6   | C608     | 2203-000140                 | C-CERAMIC,CHIP;1.5nF,10%,50V,X7R,TP,1608   | .....6   | IC702    | 1001-001177                 | IC-VIDEO SWITCH;TEA6425D,VIDEO SWITCH ,S     |
| .....6   | C611     | 2203-000440                 | C-CERAMIC,CHIP;1nF,10%,50V,X7R,TP,1608,-   | .....6   | IC704    | 1002-001048                 | IC-A/D&A CONVERTER;PCF8591T,8BIT,SOP,1       |
| .....6   | C613     | 2203-000440                 | C-CERAMIC,CHIP;1nF,10%,50V,X7R,TP,1608,-   | .....6   | L125     | 2703-000398                 | INDUCTOR-SMD;10uH,10%,3.2x2.5x2.2mm          |
| .....6   | C614     | 2203-000140                 | C-CERAMIC,CHIP;1.5nF,10%,50V,X7R,TP,1608   | .....6   | L126     | 2703-000398                 | INDUCTOR-SMD;10uH,10%,3.2x2.5x2.2mm          |
| .....6   | C619     | 2203-000189                 | C-CERAMIC,CHIP;100nF,+80-20%,25V,Y5V,TP,   | .....6   | L601     | 2703-000398                 | INDUCTOR-SMD;10uH,10%,3.2x2.5x2.2mm          |
| .....6   | C634     | 2203-000189                 | C-CERAMIC,CHIP;100nF,+80-20%,25V,Y5V,TP,   | .....6   | L602     | 2703-000398                 | INDUCTOR-SMD;10uH,10%,3.2x2.5x2.2mm          |
| .....6   | C635     | 2203-001211                 | C-CERAMIC,CHIP;8.2nF,10%,50V,X7R,TP,1608   | .....6   | L603     | 2703-000398                 | INDUCTOR-SMD;10uH,10%,3.2x2.5x2.2mm          |
| .....6   | C636     | 2203-001211                 | C-CERAMIC,CHIP;8.2nF,10%,50V,X7R,TP,1608   | .....6   | L604     | 2703-000398                 | INDUCTOR-SMD;10uH,10%,3.2x2.5x2.2mm          |
| .....6   | C637     | 2203-001211                 | C-CERAMIC,CHIP;8.2nF,10%,50V,X7R,TP,1608   | .....6   | L701     | 2703-000398                 | INDUCTOR-SMD;10uH,10%,3.2x2.5x2.2mm          |
| .....6   | C638     | 2203-001211                 | C-CERAMIC,CHIP;8.2nF,10%,50V,X7R,TP,1608   | .....6   | L702     | 3301-001324                 | CORE-FERRITE BEAD;AB,150HM,2X1.25X0.9MM,     |
| .....6   | C641     | 2203-000189                 | C-CERAMIC,CHIP;100nF,+80-20%,25V,Y5V,TP,   | .....6   | L707     | 2703-000398                 | INDUCTOR-SMD;10uH,10%,3.2x2.5x2.2mm          |
| .....6   | C651     | 2203-000189                 | C-CERAMIC,CHIP;100nF,+80-20%,25V,Y5V,TP,   | .....6   | L708     | 2703-000398                 | INDUCTOR-SMD;10uH,10%,3.2x2.5x2.2mm          |
| .....6   | C653     | 2203-000332                 | C-CERAMIC,CHIP;0.012nF,5%,50V,NPO,TP,160   | .....6   | L901     | 2703-000398                 | INDUCTOR-SMD;10uH,10%,3.2x2.5x2.2mm          |
| .....6   | C654     | 2203-000332                 | C-CERAMIC,CHIP;0.012nF,5%,50V,NPO,TP,160   | .....6   | L902     | 2703-000398                 | INDUCTOR-SMD;10uH,10%,3.2x2.5x2.2mm          |
| .....6   | C655     | 2203-001071                 | C-CERAMIC,CHIP;0.056nF,5%,50V,NPO,TP,160   | .....6   | PCB      | AA41-00597A                 | PCB-MAIN;FR-4,2LA,1.6T,245X245,COMMAND S.N.A |
| .....6   | C657     | 2203-000189                 | C-CERAMIC,CHIP;100nF,+80-20%,25V,Y5V,TP,   | .....6   | Q101     | 0501-000344                 | TR-SMALL SIGNAL;KSC1623-G,NPN,200mW,SOT-     |
| .....6   | C658     | 2203-001071                 | C-CERAMIC,CHIP;0.056nF,5%,50V,NPO,TP,160   | .....6   | Q102     | 0501-000344                 | TR-SMALL SIGNAL;KSC1623-G,NPN,200mW,SOT-     |
| .....6   | C659     | 2203-001071                 | C-CERAMIC,CHIP;0.056nF,5%,50V,NPO,TP,160   | .....6   | Q103     | 0501-000344                 | TR-SMALL SIGNAL;KSC1623-G,NPN,200mW,SOT-     |
| .....6   | C660     | 2203-000236                 | C-CERAMIC,CHIP;0.1nF,5%,50V,NPO,TP,1608    | .....6   | Q104     | 0501-000344                 | TR-SMALL SIGNAL;KSC1623-G,NPN,200mW,SOT-     |
| .....6   | C661     | 2203-000236                 | C-CERAMIC,CHIP;0.1nF,5%,50V,NPO,TP,1608    | .....6   | Q105     | 0501-000344                 | TR-SMALL SIGNAL;KSC1623-G,NPN,200mW,SOT-     |
| .....6   | C663     | 2203-000189                 | C-CERAMIC,CHIP;100nF,+80-20%,25V,Y5V,TP,   | .....6   | Q106     | 0501-000344                 | TR-SMALL SIGNAL;KSC1623-G,NPN,200mW,SOT-     |
| .....6   | C701     | 2203-005590                 | C-CERAMIC,CHIP;330NF,10%,16V,X7R,TP,2012   | .....6   | Q703     | 0501-000344                 | TR-SMALL SIGNAL;KSC1623-G,NPN,200mW,SOT-     |
| .....6   | C702     | 2203-005590                 | C-CERAMIC,CHIP;330NF,10%,16V,X7R,TP,2012   | .....6   | Q704     | 0501-000344                 | TR-SMALL SIGNAL;KSC1623-G,NPN,200mW,SOT-     |
| .....6   | C703     | 2203-005590                 | C-CERAMIC,CHIP;330NF,10%,16V,X7R,TP,2012   | .....6   | Q707     | 0501-000344                 | TR-SMALL SIGNAL;KSC1623-G,NPN,200mW,SOT-     |
| .....6   | C704     | 2203-005590                 | C-CERAMIC,CHIP;330NF,10%,16V,X7R,TP,2012   | .....6   | Q708     | 0501-000344                 | TR-SMALL SIGNAL;KSC1623-G,NPN,200mW,SOT-     |
| .....6   | C705     | 2203-005005                 | C-CERAMIC,CHIP;100nF,+80-20%,16V,Y5V,TP,   | .....6   | Q709     | 0501-000344                 | TR-SMALL SIGNAL;KSC1623-G,NPN,200mW,SOT-     |
| .....6   | C707     | 2203-000189                 | C-CERAMIC,CHIP;100nF,+80-20%,25V,Y5V,TP,   | .....6   | Q710     | 0501-000344                 | TR-SMALL SIGNAL;KSC1623-G,NPN,200mW,SOT-     |
| .....6   | C709     | 2203-000189                 | C-CERAMIC,CHIP;100nF,+80-20%,25V,Y5V,TP,   | .....6   | R101     | 2007-000070                 | R-CHIP;0ohm,5%,1/16W,DA,TP,1608              |
| .....6   | C710     | 2203-001652                 | C-CERAMIC,CHIP;470nF,+80-20%,16V,Y5V,TP,   | .....6   | R102     | 2007-000074                 | R-CHIP;100ohm,5%,1/16W,DA,TP,1608            |
| .....6   | C711     | 2203-001652                 | C-CERAMIC,CHIP;470nF,+80-20%,16V,Y5V,TP,   | .....6   | R103     | 2007-000074                 | R-CHIP;100ohm,5%,1/16W,DA,TP,1608            |
| .....6   | C712     | 2203-001652                 | C-CERAMIC,CHIP;470nF,+80-20%,16V,Y5V,TP,   | .....6   | R104     | 2007-000828                 | R-CHIP;39Kohm,1%,1/16W,DA,TP,1608            |
| .....6   | C713     | 2203-001652                 | C-CERAMIC,CHIP;470nF,+80-20%,16V,Y5V,TP,   | .....6   | R105     | 2007-000098                 | R-CHIP;56Kohm,5%,1/16W,DA,TP,1608            |
| .....6   | C714     | 2203-001652                 | C-CERAMIC,CHIP;470nF,+80-20%,16V,Y5V,TP,   | .....6   | R106     | 2007-000078                 | R-CHIP;1Kohm,5%,1/16W,DA,TP,1608             |



| Loc. No. | Code No.    | Description ; Specification              | Remark                                    | Loc. No. | Code No. | Description ; Specification | Remark                                   |  |
|----------|-------------|--|---|----------|----------|-----------------------------|--|--|
| ..2      | BP94-00153A | ASSY PCB MISC-A/V-FRONT;HCM4216WX/XAA,P5 |   | ....4    | CZ110    | 2201-000604                 | C-CERAMIC,DISC;0.056nF,+100-0%,500V,SL,T |  |
| ...3     | CNW01A      | BP39-00016A                              | LEAD CONNECTOR ASSY;P55A/HCM4215W,UL2547  | ....4    | CZ111    | 2401-000480                 | C-AL;10uF,20%,50V,GP,TP,5x11,5           |  |
| ...3     | CNW702      | AA39-00260A                              | LEAD CONNECTOR ASSY;UL1007#26,UL/CSA,3P   | ....4    | CZ112    | 2401-000832                 | C-AL;220uF,20%,25V,GP,TP,8x11,5,5        |  |
| ...3     | CNY01A      | 3711-003601                              | CONNECTOR-HEADER;BOX,12P,1R,2.5mm,ANGLE   | ....4    | DZ101    | 0402-000546                 | DIODE-RECTIFIER;TVR10G,400V,1.0A,DO-41,T |  |
| ...3     | CNY702      | 3711-000447                              | CONNECTOR-HEADER;3WALL,3P,1R,2.5mm,ANGLE  | ....4    | DZ102    | 0401-000005                 | DIODE-SWITCHING;1N4148,100V,200mA,DO-35, |  |
| ...3     | JK101       | 3722-000544                              | JACK-VHS;4P;11.5mm,AG,BLK,N               | ....4    | DZ103    | 0402-000546                 | DIODE-RECTIFIER;TVR10G,400V,1.0A,DO-41,T |  |
| ...3     | JK102       | 3722-001164                              | JACK-PIN;3P;3.4mm,SN,WH;YE:RE,#16-22      | ....4    | DZ104    | 0402-000546                 | DIODE-RECTIFIER;TVR10G,400V,1.0A,DO-41,T |  |
| ...3     | SW101       | 3404-000208                              | SWITCH-TACT;12V,50mA,120gf,6x6mm,SPST     | ....4    | DZ105    | 0401-000005                 | DIODE-SWITCHING;1N4148,100V,200mA,DO-35, |  |
| ...3     |             | BP96-00007G                              | ASSY COVER P-SIDE;JACK;42W5,ABS HB G3676  | ....4    | DZ106    | 0401-000005                 | DIODE-SWITCHING;1N4148,100V,200mA,DO-35, |  |
| ....4    |             | AA61-01128B                              | HOLDER-SIDE,A/V;43T7,ABS HB,G3676,SVM-11  | S.N.A    | ....4    | LZ101                       | 2701-000002                              | INDUCTOR-AXIAL;100uH,10%,4,2x9,8mm       |
| ....4    |             | AA64-02086E                              | INLAY-AV;W3,PS SHEET,TO.5,P55A            | S.N.A    | ....4    | PCB                         | AA41-00611A                              | PCB-VM;-FR-1,1LA,1.6T,245X245,6A,113X62  |
| ....4    |             | AA64-02780B                              | DOOR-AV;43T7,ABS HB,G3676,SVM-1132        | S.N.A    | ....4    | QZ103                       | 0501-000283                              | TR-SMALL SIGNAL;KSA539,PNP,400mW,TO-92,T |
| ...3     |             | AA97-07429A                              | ASSY AUTO;0000                            | S.N.A    | ....4    | OZ104                       | 0501-000389                              | TR-SMALL SIGNAL;KSC815,NPN,400mW,TO-92,T |
| ....4    | PCB         | AA41-00499B                              | PCB-FRONT A/V;SVP-54T6SR,FR-1,1LA,1.6T,   | S.N.A    | ....4    | QZ105                       | 0501-000389                              | TR-SMALL SIGNAL;KSC815,NPN,400mW,TO-92,T |
| ....4    | RK101       | 2001-000006                              | R-CARBON;2.4KOHM,5%,1/8W,AA,TP,1.8X3.2MM  | S.N.A    | ....4    | OZ106                       | 0501-000389                              | TR-SMALL SIGNAL;KSC815,NPN,400mW,TO-92,T |
| ....2    |             | 0202-000187                              | SOLDER-WIRE FLUX;-RS60S,D1.2.63Sn/37Pb    | S.N.A    | ....4    | RFZ101                      | 2008-001086                              | R-FUSIBLE(S);3.3ohm,5%,2W,AG,TP,3.9x12mm |
| ..2      |             | AA94-08576A                              | ASSY PCB MISC-CONTROL;-HCM4215W,P55A      |          | ....4    | RZ101                       | 2001-000241                              | R-CARBON;1.5KOHM,5%,1/8W,AA,TP,1.8X3.2MM |
| ...3     | CNW01       | AA39-00223A                              | LEAD CONNECTOR ASSY;11P;67096-011,35155   |          | ....4    | RZ102                       | 2001-000221                              | R-CARBON;1.2KOHM,5%,1/8W,AA,TP,1.8X3.2MM |
| ...3     | CNW02       | AA39-00259A                              | LEAD CONNECTOR ASSY;UL1007#26,UL/CSA,3P   |          | ....4    | RZ103                       | 2003-000713                              | R-METAL OXIDE(S);47ohm,5%,2W,AF,TP,4x12m |
| ...3     | CNY01       | 3711-003353                              | CONNECTOR-HEADER;BOX,11P,1R,2.5mm,ANGLE   |          | ....4    | RZ104                       | 2001-001100                              | R-CARBON(S);2.7OHM,5%,1/2W,AA,TP,2.4X6.4 |
| ...3     | CNY02       | 3711-000447                              | CONNECTOR-HEADER;3WALL,3P,1R,2.5mm,ANGLE  |          | ....4    | RZ105                       | 2001-001139                              | R-CARBON(S);39KOHM,5%,1/2W,AA,TP,2.4X6.4 |
| ...3     | LEDY01      | 0601-001381                              | LED;ROUND,RED,GRN,5.0MM,650/563NM         |          | ....4    | RZ106                       | 2001-001139                              | R-CARBON(S);39KOHM,5%,1/2W,AA,TP,2.4X6.4 |
| ...3     | RMY01       | AA32-00012A                              | MODULE REMOCON;ORC-50HF2,38KHZ,940NM,MES  |          | ....4    | RZ107                       | 2001-000331                              | R-CARBON;12KOHM,5%,1/8W,AA,TP,1.8X3.2MM  |
| ...3     | SWY01       | 3404-001006                              | SWITCH-TACT;12V,50mA,160gf,6x6mm,SPST     |          | ....4    | RZ108                       | 2001-000241                              | R-CARBON;1.5KOHM,5%,1/8W,AA,TP,1.8X3.2MM |
| ...3     | SWY02       | 3404-001006                              | SWITCH-TACT;12V,50mA,160gf,6x6mm,SPST     |          | ....4    | RZ109                       | 2001-000221                              | R-CARBON;1.2KOHM,5%,1/8W,AA,TP,1.8X3.2MM |
| ...3     | SWY03       | 3404-001006                              | SWITCH-TACT;12V,50mA,160gf,6x6mm,SPST     |          | ....4    | RZ110                       | 2001-001100                              | R-CARBON(S);2.7OHM,5%,1/2W,AA,TP,2.4X6.4 |
| ...3     | SWY04       | 3404-001006                              | SWITCH-TACT;12V,50mA,160gf,6x6mm,SPST     |          | ....4    | RZ111                       | 2003-000713                              | R-METAL OXIDE(S);47ohm,5%,2W,AF,TP,4x12m |
| ...3     | SWY05       | 3404-001006                              | SWITCH-TACT;12V,50mA,160gf,6x6mm,SPST     |          | ....4    | RZ112                       | 2003-002157                              | R-METAL OXIDE;220OHM,5%,2W,AG,TP,6X16MM  |
| ...3     | SWY06       | 3404-001006                              | SWITCH-TACT;12V,50mA,160gf,6x6mm,SPST     |          | ....4    | RZ113                       | 2003-002157                              | R-METAL OXIDE;220OHM,5%,2W,AG,TP,6X16MM  |
| ...3     | SWY07       | 3404-001006                              | SWITCH-TACT;12V,50mA,160gf,6x6mm,SPST     |          | ....4    | RZ114                       | 2003-000532                              | R-METAL OXIDE(S);18ohm,5%,2W,AF,TP,4x12m |
| ...3     | SWY08       | 3404-001006                              | SWITCH-TACT;12V,50mA,160gf,6x6mm,SPST     |          | ....4    | RZ115                       | 2001-000832                              | R-CARBON;510OHM,5%,1/8W,AA,TP,1.8X3.2MM  |
| ...3     |             | 3301-001201                              | CORE-FERRITE;AE,21x11x32mm,1500,280G      |          | ....4    | RZ116                       | 2001-000331                              | R-CARBON;12KOHM,5%,1/8W,AA,TP,1.8X3.2MM  |
| ...3     |             | 0202-000187                              | SOLDER-WIRE FLUX;-RS60S,D1.2.63Sn/37Pb    | S.N.A    | ....4    | RZ117                       | 2001-000258                              | R-CARBON;1.8KOHM,5%,1/8W,AA,TP,1.8X3.2MM |
| ...3     |             | AA97-07423A                              | ASSY AUTO;0000                            | S.N.A    | ....4    | RZ118                       | 2001-000258                              | R-CARBON;1.8KOHM,5%,1/8W,AA,TP,1.8X3.2MM |
| ....4    | CY01        | 2401-002009                              | C-AL;100uF,20%,16V,GP,TP,6.3x7,5          |          | ....4    | RZ119                       | 2001-000554                              | R-CARBON;270OHM,5%,1/8W,AA,TP,1.8X3.2MM  |
| ....4    | DZY02       | 0403-000510                              | DIODE-ZENER;MTZJ6.2B,6.2V,5.96-6.27V,500  |          | ....4    | RZ121                       | 2001-000666                              | R-CARBON;330OHM,5%,1/8W,AA,TP,1.8X3.2MM  |
| ....4    | DZY03       | 0403-000510                              | DIODE-ZENER;MTZJ6.2B,6.2V,5.96-6.27V,500  |          | ....4    | RZ122                       | 2001-000019                              | R-CARBON(S);100HM,5%,1/2W,AA,TP,2.4X6.4M |
| ....4    | PCB         | BP41-00001C                              | PCB-CONTROL;SVP-42W5HD,FR-1,1LA,C,1.6T,33 | S.N.A    | ....4    | RZ123                       | 2003-002157                              | R-METAL OXIDE;220OHM,5%,2W,AG,TP,6X16MM  |
| ....4    | QY01        | 0504-000123                              | TR-DIGITAL;KSR1010,NPN,300mW,10K,TO-92,T  |          | ..2      |                             | AA94-08270A                              | ASSY PCB MISC-DY JACK;COMMANDO           |
| ....4    | RY02        | 2001-000832                              | R-CARBON;510OHM,5%,1/8W,AA,TP,1.8X3.2MM   |          | ...3     | GT01                        | AA60-40012D                              | PIN-GT,ASSY;4P,T1.6,6-12.5-14MM,NYLON66  |
| ....4    | RY03        | 2001-000832                              | R-CARBON;510OHM,5%,1/8W,AA,TP,1.8X3.2MM   |          | ...3     | GT05                        | AA60-40012D                              | PIN-GT,ASSY;4P,T1.6,6-12.5-14MM,NYLON66  |
| ....4    | RY04        | 2001-000429                              | R-CARBON;1KOHM,5%,1/8W,AA,TP,1.8X3.2MM    |          | ...3     | GT09                        | AA60-40012D                              | PIN-GT,ASSY;4P,T1.6,6-12.5-14MM,NYLON66  |
| ....4    | RY05        | 2001-000832                              | R-CARBON;510OHM,5%,1/8W,AA,TP,1.8X3.2MM   |          | ...3     | GT13                        | AA60-40012D                              | PIN-GT,ASSY;4P,T1.6,6-12.5-14MM,NYLON66  |
| ....4    | RY06        | 2001-000924                              | R-CARBON;680OHM,5%,1/8W,AA,TP,1.8X3.2MM   |          | ...3     |                             | AA61-01197A                              | HOLDER-PCB,DY;COMANDO,ABS V0,BLK         |
| ....4    | RY07        | 2001-000020                              | R-CARBON(S);220HM,5%,1/2W,AA,TP,2.4X6.4M  |          | ...3     |                             | AA97-07230N                              | ASSY AUTO;COMMANDO                       |
| ....4    | RY08        | 2001-001108                              | R-CARBON(S);22KOHM,5%,1/2W,AA,TP,2.4X6.4  |          | ....4    | PCB                         | AA41-00632A                              | PCB-DY CONNECTION;-FR-1,1LA,1.6T,245X24  |
| ....4    | RY09        | 2001-000109                              | R-CARBON(S);470OHM,5%,1/2W,AA,TP,2.4X6.4  |          | ....4    | R301                        | 2001-001107                              | R-CARBON(S);220ohm,5%,1/2W,AA,TP,2.4x6.4 |
| ..2      |             | AA61-01127A                              | HOLDER-CHASSIS;COMMANDO,HIPS V0,G4309     | S.N.A    | ....4    | R302                        | 2001-001107                              | R-CARBON(S);220ohm,5%,1/2W,AA,TP,2.4x6.4 |
| ..2      |             | AA94-08268A                              | ASSY PCB MISC-VM;COMMANDO                 | S.N.A    | ....4    | R303                        | 2001-001107                              | R-CARBON(S);220ohm,5%,1/2W,AA,TP,2.4x6.4 |
| ...3     | CNZ101      | AA39-20055C                              | LEAD CONNECTOR-ASSY;6PYBNH025-06,67096    |          | ...3     |                             | 0202-000187                              | SOLDER-WIRE FLUX;-RS60S,D1.2.63Sn/37Pb   |
| ...3     | QZ101       | AA96-00243M                              | ASSY H/S;-AMP;AA62-000450A,2SA1011,HERC   | S.N.A    | ..2      |                             | AA94-08380A                              | ASSY PCB MISC-SENSOR;SVP-55W9HD,P54A     |
| ....4    |             | 0205-000129                              | GREASE-SILICON;SC102,JAPAN                | S.N.A    | ...3     | CN01                        | 3711-000447                              | CONNECTOR-HEADER;3WALL,3P,1R,2.5mm,ANGLE |
| ....4    |             | 0502-000131                              | TR-POWER;2SA1011-D,PNP,1.2W,TO-220,-.60   |          | ...3     | Q01                         | 0603-001098                              | PHOTO TR;NPN,20V,5V,20MA,50MWT,ST        |
| ....4    |             | 6003-000335                              | SCREW-TAPTITE;RH,+,2S,M3,L8,ZP(YEL),SWR   | S.N.A    | ...3     |                             | 0202-000187                              | SOLDER-WIRE FLUX;-RS60S,D1.2.63Sn/37Pb   |
| ....4    |             | AA62-00045A                              | HEAT SINK-PS;-T1.0,-.DREAM,-.,-,-,-.      | S.N.A    | ...3     |                             | AA97-07428A                              | ASSY AUTO;0000                           |
| ...3     | QZ102       | AA96-00243I                              | ASSY H/S;-CRT;AA62-000450A,2SC2344,HERC   | S.N.A    | ....4    | PCB                         | AA41-00741A                              | PCB-SENSOR;SVP-55W9HD,FR-4,2LA,1.6T,245  |
| ....4    |             | 0205-000129                              | GREASE-SILICON;SC102,JAPAN                | S.N.A    | ....4    | R01                         | 2001-000522                              | R-CARBON;22KOHM,5%,1/8W,AA,TP,1.8X3.2MM  |
| ....4    |             | 0502-000153                              | TR-POWER;2SC2344-D,NPN,1.2W,TO-220,-.60   |          | ..2      |                             | AA94-08574A                              | ASSY PCB MISC-PWR-DEF;-HCM4215W,P55A     |
| ....4    |             | 6003-000335                              | SCREW-TAPTITE;RH,+,2S,M3,L8,ZP(YEL),SWR   | S.N.A    | ...3     | C432                        | 2303-000002                              | PEF CAPACITOR;8.2nF,5%,400V,TP,19x18X7,7 |
| ....4    |             | AA62-00045A                              | HEAT SINK-PS;-T1.0,-.DREAM,-.,-,-,-.      | S.N.A    | ...3     | C438                        | 2303-000002                              | PEF CAPACITOR;8.2nF,5%,400V,TP,19x18X7,7 |
| ...3     | RZ120       | 2008-001097                              | R-FUSIBLE(S);330HM,5%,1/2W,AC,BK,2.5X6.5  |          | ...3     | C491                        | 2306-000322                              | C-FILM,MPPF;12nF,5%,1.6KV,TP,29x20.5x13, |
| ...3     |             | AA33-00017A                              | MAGNET CONVERGENCE;JH 92LT - 29G,-.29.1M  |          | ...3     | C814                        | 2301-001041                              | C-FILM,PPF;15nF,5%,1.6KV,TP,29x14x21,5,2 |
| ...3     |             | 3301-001201                              | CORE-FERRITE;AE,21x11x32mm,1500,280G      |          | ...3     | C815                        | 2401-000701                              | C-AL;2200uF,20%,250V,GP,-,35x70mm,1,     |
| ...3     |             | 0202-000187                              | SOLDER-WIRE FLUX;-RS60S,D1.2.63Sn/37Pb    | S.N.A    | ...3     | C816                        | 2401-000701                              | C-AL;2200uF,20%,250V,GP,-,35x70mm,1,     |
| ...3     |             | AA97-07230M                              | ASSY AUTO;COMMANDO                        | S.N.A    | ...3     | C832                        | 2306-000323                              | C-FILM,MPPF;2.2nF,5%,1.6KV,TP,28.5x15.5x |
| ....4    | CNZ102      | 3711-002642                              | CONNECTOR-HEADER;BOX,3P,1R,2.5mm,STRAIGH  |          | ...3     | C850                        | 2401-003076                              | C-AL;3300uF,20%,50V,W/P,BK,18x35.5mm     |
| ....4    | CNZ103      | 3711-002642                              | CONNECTOR-HEADER;BOX,3P,1R,2.5mm,STRAIGH  |          | ...3     | C852                        | 2401-003076                              | C-AL;3300uF,20%,50V,W/P,BK,18x35.5mm     |
| ....4    | CNZ104      | 3711-002642                              | CONNECTOR-HEADER;BOX,3P,1R,2.5mm,STRAIGH  |          | ...3     | C856                        | 2401-003076                              | C-AL;3300uF,20%,50V,W/P,BK,18x35.5mm     |
| ....4    | CZ101       | 2401-002144                              | C-AL;47uF,20%,16V,GP,TP,5x11,5            |          | ...3     | C858                        | 2401-000698                              | C-AL;2200uF,20%,16V,WT,TP,12.5x25,5,     |
| ....4    | CZ102       | 2401-001157                              | C-AL;33uF,20%,160V,GP,TP,12.5x20,5        |          | ...3     | C863                        | 2401-002251                              | C-AL;470uF,20%,200V,GP,BK,25x40mm,1      |
| ....4    | CZ103       | 2201-000516                              | C-CERAMIC,DISC;4.7nF,+100-0%,500V,Y5U,TP  |          | ...3     | C864                        | 2401-000787                              | C-AL;220uF,20%,160V,GP,TP,16x31,5mm      |
| ....4    | CZ104       | 2201-000193                              | C-CERAMIC,DISC;0.01nF,0.25pF,50V,NP0,TP   |          | ...3     | C870                        | 2401-000142                              | C-AL;1000uF,20%,16V,WT,TP,10x20,5,       |
| ....4    | CZ105       | 2201-000516                              | C-CERAMIC,DISC;4.7nF,+100-0%,500V,Y5U,TP  |          | ...3     | CN801                       | AA39-00180A                              | LEAD CONNECTOR ASSY;14PYBNH250-14,3515   |
| ....4    | CZ106       | 2201-000193                              | C-CERAMIC,DISC;0.01nF,0.25pF,50V,NP0,TP   |          | ...3     | CN802                       | BP39-00014A                              | LEAD CONNECTOR ASSY;P55A/HCM4215W,UL1007 |
| ....4    | CZ107       | 2401-001513                              | C-AL;47uF,20%,16V,WT,TP,5x11,5            |          | ...3     | CN803                       | 3711-003043                              | CONNECTOR-HEADER;BOX,4P,1R,2.5mm,STRAIGH |
| ....4    | CZ108       | 2401-001220                              | C-AL;4.7uF,20%,160V,GP,TP,8x11.5,5        |          | ...3     | CR430S                      | 2301-001343                              | C-FILM,MPPF;3.9nF,5%,2kV,TP,29x9.5x16mm, |
| ....4    | CZ109       | 2401-001220                              | C-AL;4.7uF,20%,160V,GP,TP,8x11.5,5        |          | △...3    | CR431S                      | 2301-001343                              | C-FILM,MPPF;3.9nF,5%,2kV,TP,29x9.5x16mm, |

| Loc. No. | Code No.    | Description ; Specification                | Remark                                     | Loc. No. | Code No.    | Description ; Specification              | Remark                                     |  |  |
|----------|-------------|--|--|----------|-------------|--|--|--|--|
| △ ...3   | CR436S      | 2306-000235                                | C-FILM,MPPF;560nF,5%,400V,TP,26*22.5*14,   | ...4     | AA62-00045A | HEAT SINK-PS,-,-,T1.0,-,-,DREAM,-,-,-,-  | S.N.A                                      |  |  |
| △ ...3   | CR471S      | 2301-001091                                | C-FILM,MPPF;470nF,5%,400V,TP,26x21.5x14,   | ...3     | Q472        | 0505-000156                              | FET-SILICON;IRF620,N,200V,5A,0.8ohm,50W,   |  |  |
| △ ...3   | CR473S      | 2306-000322                                | C-FILM,MPPF;12nF,5%,1.6KV,TP,29x20.5x13,   | ...3     | Q473        | BP96-00006A                              | ASSY HEAT SINK P;BP62-00001A,SCREW,2SC41   | S.N.A                                    |  |
| △ ...3   | CR474S      | 2306-000326                                | C-FILM,MPPF;4.7nF,5%,1.6KV,TP,28.5x16x9mm  | ...4     | BP62-00001A | HEAT SINK;COMMANDO,A1050P,T2.0,W62.0,H50 | S.N.A                                      |  |  |
| △ ...3   | CX801S      | 2306-000112                                | C-FILM,MPPF;100nF,20%,250V,BK,-,15mm       | ...4     | 6003-000335 | SCREW-TAPTITE;RH,+2S,M3,L8,ZPC(YEL),SWR  | S.N.A                                      |  |  |
| △ ...3   | CX802S      | 2306-000112                                | C-FILM,MPPF;100nF,20%,250V,BK,-,15mm       | ...4     | 0505-001202 | FET-SILICON;IRFS640A,N,200V,9.8A,0.18ohm |  |  |  |
| △ ...3   | CY801S      | 2201-000987                                | C-CERAMIC,DISC;2.2nF,20%,400V,Y5U,TP,12.   | ...4     | 0502-001100 | TR-POWER;2SC4115,NPN,70W,TO-3PML,BK,8-   |  |  |  |
| △ ...3   | CY802S      | 2201-000987                                | C-CERAMIC,DISC;2.2nF,20%,400V,Y5U,TP,12.   | ...4     | 0205-000129 | GREASE-SILICON;SC102,JAPAN               | S.N.A                                      |  |  |
| △ ...3   | CY803S      | 2201-000963                                | C-CERAMIC,DISC;1nF,20%,400V,Y5U,TP,9.5x6   | ...3     | R424        | 2008-000289                              | R-FUSIBLE(S);1ohm,5%,1W,AA,TP,3.9x10mm     |  |  |
| △ ...3   | CY804S      | 2201-000963                                | C-CERAMIC,DISC;1nF,20%,400V,Y5U,TP,9.5x6   | ...3     | R425        | 2003-000417                              | R-METAL OXIDE(S);1.2Kohm,5%,3W,AA,TP,6x1   |  |  |
| △ ...3   | CY811S      | 2201-000446                                | C-CERAMIC,DISC;3.3nF,20%,400V,Y5U,TP,15x   | ...3     | R440        | 2008-000282                              | R-FUSIBLE;0.47ohm,5%,1W,AA,TP,3.9x12mm     |  |  |
| △ ...3   | CY812S      | 2201-000446                                | C-CERAMIC,DISC;3.3nF,20%,400V,Y5U,TP,15x   | ...3     | R831        | 2003-000512                              | R-METAL OXIDE(S);15Kohm,5%,3W,AA,TP,6x16   |  |  |
| △ ...3   | D431        | 0402-000546                                | DIODE-RECTIFIER;TVR10G,400V,1.0A,DO-41,T   | ...3     | R832        | 2003-000512                              | R-METAL OXIDE(S);15Kohm,5%,3W,AA,TP,6x16   |  |  |
| △ ...3   | D464        | 0402-000236                                | DIODE-RECTIFIER;GI824,400V,5A,-,TP         | △ ...3   | T431        | AA26-50001U                              | TRANS-HORIZ.DRIVE,-,-,28mH,-,-,105uH-      |  |  |
| △ ...3   | D811S       | AA96-00276A                                | ASSY H/S;-,-,BRIDGE,AA62-00052A,RBV606,WAS | S.N.A    | △ ...3      | T432                                     | AA26-00053A                                | TRANS;-,-,1.2mH,-,-,-,-,-,31.5KHz,-,-    |  |
| ...4     | AA62-00052A | HEAT SINK-PS,-,-,-,SILVER,HOLE 18.5mm,2,-  | S.N.A                                      | △ ...3   | T444S       | AA26-00100A                              | TRANS FBT;FFA97513L,CT29A,VDR,0.3mH,-,-,-  |  |  |
| ...4     | AA60-30003A | WASHER,-,-,-,T1.5,-,-,SBHG-1,-             | S.N.A                                      | △ ...3   | T461        | AA26-50001V                              | TRANS-HORIZ.DRIVE,-,-,6.0mH,-,-,113uH,     |  |  |
| ...4     | 6003-000335 | SCREW-TAPTITE;RH,+2S,M3,L8,ZPC(YEL),SWR    | S.N.A                                      | △ ...3   | T481        | AA26-00091A                              | TRANS-HV STORAGE;4mH,-,-,14P,830uH,180V,10 |  |  |
| ...4     | 0402-000549 | DIODE-BRIDGE;RBV606,600V,6A,-,BK           |  | △ ...3   | T801S       | BP26-00002A                              | TRANS SWITCHING;EER5345,P55A,160V-280V,P   |  |  |
| ...4     | 0205-000129 | GREASE-SILICON;SC102,JAPAN                 | S.N.A                                      | △ ...3   | TS801S      | BP26-00001A                              | TRANS-POWER SW (DPMS);19B012,P55A,HCM42    |  |  |
| △ ...3   | D831        | 0402-000250                                | DIODE-RECTIFIER;RG4C,1000V,1A,-            | △ ...3   | VX801S      | 1405-000187                              | VARISTOR;750V,1250A,12.5x7mm,TP            |  |  |
| △ ...3   | D855        | AA96-00243E                                | ASSY H/S;-,-,SOUND,AA62-00045A,FMG-G26S    | S.N.A    | ...3        | 0202-000187                              | SOLDER-WIRE FLUX;-,-,RS60S,D1.2,63Sn/37Pb  | S.N.A                                    |  |
| △ ...3   | D856        | AA96-00243E                                | ASSY H/S;-,-,SOUND,AA62-00045A,FMG-G26S    | S.N.A    | ...3        | 3301-001201                              | CORE-FERRITE;AE,21x11x32mm,1500,280G       |  |  |
| ...4     | 0205-000129 | GREASE-SILICON;SC102,JAPAN                 | S.N.A                                      | ...3     | BP39-00017A | LEAD CONNECTOR;P55A/HCM4215W,UL1617#22,U |  |  |  |
| ...4     | 0402-000231 | DIODE-RECTIFIER;FMG-G26S,600V,4A,TO-220F   |  | ...4     | 3301-001201 | CORE-FERRITE;AE,21x11x32mm,1500,280G     |  |  |  |
| ...4     | 6003-000335 | SCREW-TAPTITE;RH,+2S,M3,L8,ZPC(YEL),SWR    | S.N.A                                      | ...3     | AA97-07506Z | ASSY AUTO-PWR DEF;HCM4215W               | S.N.A                                      |  |  |
| ...4     | AA62-00045A | HEAT SINK-PS,-,-,T1.0,-,-,DREAM,-,-,-,-    | S.N.A                                      | ...4     | C301        | 2305-000427                              | C-FILM,MPEF;47nF,5%,100V,TP,7.5x12.5x3.5   |  |  |
| ...3     | DZS801      | 0406-001007                                | DIODE-TVS;PK6180A,171/180/189V,600V,CAS    | ...4     | C302        | 2201-000292                              | C-CERAMIC,DISC;1nF,10%,50V,Y5P,TP,5x3.5,   |  |  |
| △ ...3   | FP801S      | 3601-000300                                | FUSE-CARTRIDGE;250V,6.3A,SLOW-BLOW,GLASS   | ...4     | C303        | 2305-000427                              | C-FILM,MPEF;47nF,5%,100V,TP,7.5x12.5x3.5   |  |  |
| ...3     | GT01        | AA60-00012D                                | PIN-GT,ASSY;APT1.6,6-12.5-14MM,NYLON66     | S.N.A    | ...4        | C304                                     | 2201-000292                                | C-CERAMIC,DISC;1nF,10%,50V,Y5P,TP,5x3.5, |  |
| ...3     | IC301       | AA96-00623A                                | ASSY H/S;-,-,POWER,AA62-00056A,LA7845      | S.N.A    | ...4        | C307                                     | 2401-000365                                | C-AL;100uF,20%,50V,WT,TP,10x12.5mm,      |  |
| ...4     | 0205-000129 | GREASE-SILICON;SC102,JAPAN                 | S.N.A                                      | ...4     | C308        | 2401-000365                              | C-AL;100uF,20%,50V,WT,TP,10x12.5mm,        |  |  |
| ...4     | 1204-000517 | IC-VERTICAL DEF;LA7845,SIP,7P,-,PLASTIC    |  | ...4     | C309        | 2305-000285                              | C-FILM,MPEF;220nF,5%,100V,TP,10.5x5.5x15   |  |  |
| ...4     | 6003-000334 | SCREW-TAPTITE;RH,+2S,M3,L6,ZPC(YEL),SWR    | S.N.A                                      | ...4     | C311        | 2305-000149                              | C-FILM,MPEF;100nF,5%,100V,TP,12x12.5x6.5   |  |  |
| ...4     | AA62-00056A | HEAT SINK-PS,-,-,T1.0,-,-,41*35*70,D2,-,-, | S.N.A                                      | ...4     | C405        | 2201-000558                              | C-CERAMIC,DISC;0.47nF,10%,50V,Y5P,TP,5x3   |  |  |
| △ ...3   | IC421       | AA96-00475B                                | ASSY H/S;SILICON-OIL,FMLG-12S(4),AA62-00   | S.N.A    | ...4        | C406                                     | 2201-000370                                | C-CERAMIC,DISC;0.22nF,10%,50V,Y5P,TP,4x3 |  |
| ...4     | AA62-00066B | HEAT SINK;D2,D3,AL,T1.0,89,70,-,AA62-00    | S.N.A                                      | ...4     | C412        | 2301-000383                              | C-FILM,PEF;10nF,5%,50V,TP,6x7x3.2mm,5mm    |  |  |
| ...4     | 6003-000334 | SCREW-TAPTITE;RH,+2S,M3,L6,ZPC(YEL),SWR    | S.N.A                                      | ...4     | C413        | 2401-000360                              | C-AL;100uF,20%,50V,GPT,TP,8x11.5,5         |  |  |
| ...4     | 1203-000165 | IC-POS1.ADJ.UST REG.;78R12,TO-220,4P,-,PL  |  | ...4     | C426        | 2401-000302                              | C-AL;100uF,20%,25V,GPT,TP,6.3x11,5         |  |  |
| ...4     | 0402-000233 | DIODE-RECTIFIER;FML-G12S,200V,5A,-,-       |  | ...4     | C427        | 2401-002300                              | C-AL;47uF,20%,50V,GPT,TP,6.3x11,5          |  |  |
| ...4     | 0205-000129 | GREASE-SILICON;SC102,JAPAN                 | S.N.A                                      | ...4     | C428        | 2306-000122                              | C-FILM,MPPF;100nF,5%,50V,TP,7.3x4.0x5.0m   |  |  |
| △ ...3   | IC430       | 1203-000162                                | IC-POS1.ADJ.UST REG.;317,TO-220,3P,-,PLAS  | ...4     | C429        | 2305-000704                              | C-FILM,MPEF;100nF,5%,250V,TP,16.5x10.3x5   |  |  |
| △ ...3   | IC431       | 1201-000191                                | IC-OP AMP;4558,DIP,8P,300MIL,DUAL,20V/mV   | ...4     | C437        | 2401-003114                              | C-AL;4.7uF,20%,250V,WT,TP,10x16,5          |  |  |
| △ ...3   | IC471       | 1203-000610                                | IC-PWM CONTROLLER;494,DIP,16P,300MIL,PLA   | ...4     | C445        | 2401-001622                              | C-AL;6.8uF,20%,50V,BP,TP,16x25mm,7.        |  |  |
| △ ...3   | IC831S      | AA96-00275J                                | ASSY H/S;SCREW,SILICON-OIL,AA62-00051A,S   | S.N.A    | ...4        | C449                                     | 2201-000406                                | C-CERAMIC,DISC;0.27nF,10%,2KV,Y5P,TP,6.3 |  |
| ...4     | CIS         | 0205-000129                                | GREASE-SILICON;SC102,JAPAN                 | S.N.A    | ...4        | C450                                     | 2401-001486                                | C-AL;47uF,20%,160V,HR,TP,13x20mm,5m      |  |
| ...4     | CIS         | 6003-000333                                | SCREW-TAPTITE;RH,+2S,M3,L10,ZPC(YEL),SW    | S.N.A    | ...4        | C451                                     | 2401-000262                                | C-AL;100uF,20%,160V,HR,TP,16x25,7.5      |  |
| ...4     | CIS         | AA13-00105A                                | IC HYBRID;STR-X6456,7,-20TO+125,DIP,21A,   |          | ...4        | C452                                     | 2201-000132                                | C-CERAMIC,DISC;0.1nF,10%,500V,Y5P,TP,6.5 |  |
| ...4     | CIS         | AA62-00051A                                | HEAT SINK-PS,-,-,SILVER,HOLE 31mm,ALL,     | S.N.A    | ...4        | C453                                     | 2401-002288                                | C-AL;470uF,20%,25V,WT,TP,10x20,5         |  |
| △ ...3   | IC851       | 1203-001400                                | IC-POWER PRESCALER;SE110N,TO-220(SIP),3P   | ...4     | C454        | 2401-001428                              | C-AL;470uF,20%,50V,GPT,TP,10x20,5          |  |  |
| ...3     | ICS801      | 1203-002177                                | IC-PWM CONTROLLER;VIPER12ADIP,DIP,8P,300   | ...4     | C455        | 2201-000132                              | C-CERAMIC,DISC;0.1nF,10%,500V,Y5P,TP,6.5   |  |  |
| ...3     | ICS802      | 1203-001006                                | IC-VOLTAGE REGULATOR;78R05,TO-220F,4P,-,   | ...4     | C456        | 2401-001527                              | C-AL;47uF,20%,250V,HR,TP,13x25mm,5m        |  |  |
| ...3     | L432        | AA27-00095A                                | COIL HORIZ. WIDTH;-,-,600uH,YL9N 15x27.5 C | ...4     | C457        | 2201-000132                              | C-CERAMIC,DISC;0.1nF,10%,500V,Y5P,TP,6.5   |  |  |
| ...3     | L862        | AA27-10001C                                | COIL-CHOKE;-,-,100uH,K,-,5.0A,ST,700UH-KIR | ...4     | C458        | 2401-002288                              | C-AL;470uF,20%,25V,WT,TP,10x20,5           |  |  |
| ...3     | L863        | AA27-10001C                                | COIL-CHOKE;-,-,100uH,K,-,5.0A,ST,700UH-KIR | ...4     | C459        | 2201-000132                              | C-CERAMIC,DISC;0.1nF,10%,500V,Y5P,TP,6.5   |  |  |
| ...3     | L864        | AA27-10002L                                | COIL-CHOKE;-,-,24uH,K,-,2A,-,24UH-K,10x10m | ...4     | C460        | 2303-000331                              | C-FILM,PPF;4.7nF,5%,630V,TP,19.5x12x7,7.   |  |  |
| △ ...3   | LR401S      | AA27-30003M                                | COIL-LINEARLITY;-,-,5uH,OWA14x15,USRC0.1x6 | ...4     | C466        | 2401-002619                              | C-AL;47uF,20%,25V,GPT,TP,5x11,5            |  |  |
| △ ...3   | LX801S      | AA29-30002L                                | FILTER-LINE NOISE;-,-,10mHMIN,5A,AC90-260V | ...4     | C467        | 2401-000360                              | C-AL;100uF,20%,50V,GPT,TP,8x11.5,5         |  |  |
| △ ...3   | LX802S      | AA29-30002M                                | FILTER-LINE NOISE;-,-,1mHMIN,5A,AC90-260V, | ...4     | C468        | 2201-000119                              | C-CERAMIC,DISC;100nF,+80-20%,50V,Y5V,TP,   |  |  |
| △ ...3   | LX803S      | AA29-30002M                                | FILTER-LINE NOISE;-,-,1mHMIN,5A,AC90-260V, | ...4     | C469        | 2201-000180                              | C-CERAMIC,DISC;10nF,10%,50V,Y5V,TP,7x3,5   |  |  |
| △ ...3   | LX804S      | AA29-30002M                                | FILTER-LINE NOISE;-,-,1mHMIN,5A,AC90-260V, | ...4     | C472        | 2401-000262                              | C-AL;100uF,20%,160V,HR,TP,16x25,7.5        |  |  |
| △ ...3   | NT801S      | 1404-001195                                | THERMISTOR-NTC;5.1ohm,15%,2900,27mW/C,BK   | ...4     | C476        | 2401-001989                              | C-AL;4.7uF,20%,50V,BP,TP,5x11,5            |  |  |
| △ ...3   | PC801S      | 0604-001032                                | PHOTO-COUPLER;TR,170-260%,300mW,DIP-4,ST   | ...4     | C477        | 2301-000213                              | C-FILM,PEF;220nF,5%,250V,TP,21.5x11,7.5    |  |  |
| △ ...3   | PC811S      | 0604-001032                                | PHOTO-COUPLER;TR,170-260%,300mW,DIP-4,ST   | ...4     | C478        | 2301-000020                              | C-FILM,PEF;27nF,5%,100V,TP,7.3x4x12.5mm,   |  |  |
| ...3     | Q422        | 0505-000156                                | FET-SILICON;IRF620,N,200V,5A,0.8ohm,50W,   | ...4     | C479        | 2301-000200                              | C-FILM,PEF;2.2nF,5%,200V,TP,11.0x6.0x9.0   |  |  |
| ...3     | Q423        | 0502-000405                                | TR-POWER;-,-,NPN,70W,TO-220,BK,10          | ...4     | C480        | 2306-000122                              | C-FILM,MPPF;100nF,5%,50V,TP,7.3x4.0x5.0m   |  |  |
| ...3     | Q431        | BH99-00033H                                | ASSY HEAT/SINK;BH62-00038A,SPRING,2SC544   | S.N.A    | ...4        | C481                                     | 2401-002235                                | C-AL;10uF,20%,16V,GPT,TP,5x11mm,5mm      |  |
| ...4     | CIS         | 0502-001230                                | TR-POWER;FJL6920YDTU,N,200000MW,TO-264 F   | ...4     | C483        | 2401-000660                              | C-AL;2.2uF,20%,50V,GPT,TP,5x11,5           |  |  |
| ...4     | CIS         | 0205-001027                                | OIL-SILICON;G746,-,-                       | S.N.A    | ...4        | C484                                     | 2201-000132                                | C-CERAMIC,DISC;0.1nF,10%,500V,Y5P,TP,6.5 |  |
| ...4     | CIS         | BH73-00028A                                | SILICON/RUBBER-HS;CDT ALL,SILICON,26*33*   | S.N.A    | ...4        | C487                                     | 2305-000178                                | C-FILM,MPEF;10nF,5%,100V,TP,-,5mm        |  |
| ...4     | CIS         | BH62-00038A                                | HEAT SINK-FBT;TS17JS,A1050S,T2.0,-,-,-     | S.N.A    | ...4        | C488                                     | 2401-002144                                | C-AL;47uF,20%,16V,GPT,TP,5x11,5          |  |
| ...4     | CIS         | BH61-70003A                                | SPRING ETC;CVT4857,STS304-1W/2H,W3.8,-,L   | S.N.A    | ...4        | C489                                     | 2401-001840                                | C-AL;100uF,20%,16V,GPT,TP,6.3x11,5       |  |
| ...4     | CIS         | 0402-001296                                | DIODE-RECTIFIER;FMP-3FU,1.5KV,5A,TO-3PF,   | S.N.A    | ...4        | C490                                     | 2201-000119                                | C-CERAMIC,DISC;10nF,10%,50V,Y5V,TP,6.5   |  |
| ...3     | Q433        | AA96-00243H                                | ASSY H/S;-,-,POWER,AA62-00045A,KSD73Y,C17A | S.N.A    | ...4        | C492                                     | 2401-001026                                | C-AL;3.3UF,20%,50V,GPT,TP,5x11,5         |  |
| ...4     | 0205-000129 | GREASE-SILICON;SC102,JAPAN                 | S.N.A                                      | ...4     | C811        | 2201-000332                              | C-CERAMIC,DISC;2.2nF,20%,250V,Y5U,TP,9x4   |  |  |
| ...4     | 0502-000298 | TR-POWER;KSD73,NPN,30000mW,TO-220,TP,120   | S.N.A                                      | ...4     | C812        | 2201-000332                              | C-CERAMIC,DISC;2.2nF,20%,250V,Y5U,TP,9x4   |  |  |
| ...4     | 6003-000335 | SCREW-TAPTITE;RH,+2S,M3,L8,ZPC(YEL),SWR    | S.N.A                                      | ...4     | C813        | 2201-000332                              | C-CERAMIC,DISC;2.2nF,20%,250V,Y5U,TP,9x4   |  |  |



| Loc. No. | Code No. | Description ; Specification | Remark                                   | Loc. No. | Code No. | Description ; Specification | Remark                                    |
|----------|----------|-----------------------------|--|----------|----------|-----------------------------|---|
| ...4     | C831     | 2301-001216                 | C-FILM,PPF;47nF,5%,630V,TP,20x14.5x22,7  | ...4     | DZ483    | 0403-000720                 | DIODE-ZENER;MTZJ9.1B,9.1V,8.57-9.01V,500  |
| ...4     | C833     | 2201-000292                 | C-CERAMIC,DISC;1nF,10%,50V,Y5P,TP,5x3.5  | ...4     | DZ804    | 0403-001167                 | DIODE-ZENER;MTZJ30D,30V,29.02-30.51V,500  |
| ...4     | C834     | 2401-001625                 | C-AL;6.8uF,20%,50V,GP,TP,5x11,5          | ...4     | DZ831    | 0403-000716                 | DIODE-ZENER;MTZJ4.7B,4.7V,4.55-4.8V,500mW |
| ...4     | C835     | 2401-002144                 | C-AL;47uF,20%,16V,GP,TP,5x11,5           | ...4     | DZ851    | 0403-001325                 | DIODE-ZENER;MTZJ15C,14.35-15.09V,500mW,D  |
| ...4     | C837     | 2201-000138                 | C-CERAMIC,DISC;100pF,10%,50V,Y5P,TP,4.0X | ...4     | DZS802   | 0403-000704                 | DIODE-ZENER;TZP7.5B,7.5V,7.5-8.4V,1W,DO-  |
| ...4     | C838     | 2305-000412                 | C-FILM,MPEF;470nF,5%,63V,TP,-,5mm        | ...4     | DZS803   | 0403-001328                 | DIODE-ZENER;MTZJ22A,20.15-21.20V,500mW,D  |
| ...4     | C849     | 2401-002216                 | C-AL;2200uF,20%,35V,GP,TP,16x25,7,5      | ...4     | DZS804   | 0403-001330                 | DIODE-ZENER;MTZJ30A,26.99-28.39V,500mW,D  |
| ...4     | C851     | 2201-000551                 | C-CERAMIC,DISC;0.47nF,10%,1kV,Y5P,TP,6.3 | ...4     | EL01     | AA60-40011B                 | EYELET;ID2.0,OD3.2,-,BSP,                 |
| ...4     | C853     | 2201-000551                 | C-CERAMIC,DISC;0.47nF,10%,1kV,Y5P,TP,6.3 | ...4     | EL02     | AA60-40011B                 | EYELET;ID2.0,OD3.2,-,BSP,                 |
| ...4     | C854     | 2401-002216                 | C-AL;2200uF,20%,35V,GP,TP,16x25,7,5      | ...4     | EL03     | AA60-40011B                 | EYELET;ID2.0,OD3.2,-,BSP,                 |
| ...4     | C855     | 2201-000551                 | C-CERAMIC,DISC;0.47nF,10%,1kV,Y5P,TP,6.3 | ...4     | EL04     | AA60-40011B                 | EYELET;ID2.0,OD3.2,-,BSP,                 |
| ...4     | C857     | 2201-000551                 | C-CERAMIC,DISC;0.47nF,10%,1kV,Y5P,TP,6.3 | ...4     | EL05     | AA60-40011B                 | EYELET;ID2.0,OD3.2,-,BSP,                 |
| ...4     | C859     | 2201-000551                 | C-CERAMIC,DISC;0.47nF,10%,1kV,Y5P,TP,6.3 | ...4     | EL06     | AA60-40011B                 | EYELET;ID2.0,OD3.2,-,BSP,                 |
| ...4     | C860     | 2401-000703                 | C-AL;2200uF,20%,25V,GP,-,12.5x25mm,      | ...4     | EL07     | AA60-40011B                 | EYELET;ID2.0,OD3.2,-,BSP,                 |
| ...4     | C861     | 2401-000603                 | C-AL;1uF,20%,50V,GP,TP,5x11,5            | ...4     | EL08     | AA60-40011B                 | EYELET;ID2.0,OD3.2,-,BSP,                 |
| ...4     | C862     | 2201-000551                 | C-CERAMIC,DISC;0.47nF,10%,1kV,Y5P,TP,6.3 | ...4     | EL10     | AA60-40011B                 | EYELET;ID2.0,OD3.2,-,BSP,                 |
| ...4     | C865     | 2305-000427                 | C-FILM,MPEF;47nF,5%,100V,TP,7.5x12.5x3.5 | ...4     | EL11     | AA60-40011B                 | EYELET;ID2.0,OD3.2,-,BSP,                 |
| ...4     | C866     | 2401-001397                 | C-AL;470uF,20%,25V,GP,TP,10x16,5         | ...4     | EL12     | AA60-40011B                 | EYELET;ID2.0,OD3.2,-,BSP,                 |
| ...4     | C867     | 2201-000180                 | C-CERAMIC,DISC;10nF,10%,50V,Y5V,TP,7x3,5 | ...4     | EL13     | AA60-40011B                 | EYELET;ID2.0,OD3.2,-,BSP,                 |
| ...4     | C868     | 2401-000302                 | C-AL;100uF,20%,25V,GP,TP,6.3x11,5        | ...4     | EL14     | AA60-40011B                 | EYELET;ID2.0,OD3.2,-,BSP,                 |
| ...4     | C869     | 2401-000164                 | C-AL;1000uF,20%,25V,WT,TP,12.5x20,5      | ...4     | EL15     | AA60-40011B                 | EYELET;ID2.0,OD3.2,-,BSP,                 |
| ...4     | C871     | 2305-000289                 | C-FILM,MPEF;220nF,5%,63V,TP,-,5mm        | ...4     | EL16     | AA60-40011B                 | EYELET;ID2.0,OD3.2,-,BSP,                 |
| ...4     | CN401    | 3711-002645                 | CONNECTOR-HEADER;BOX,6P,1R,2.5mm,STRAIGH | ...4     | EY01     | AA60-40011A                 | EYELET;ID2.0,OD2.8,-,BST,                 |
| △        | CR401S   | 2401-001026                 | C-AL;3.3UF,20%,50V,GP,TP,5X11,5          | ...4     | EY02     | AA60-40011A                 | EYELET;ID2.0,OD2.8,-,BST,                 |
| △        | CR402S   | 2201-000146                 | C-CERAMIC,DISC;0.1nF,5%,50V,SL,TP,5x3.5  | ...4     | EY03     | AA60-40011A                 | EYELET;ID2.0,OD2.8,-,BST,                 |
| △        | CR403S   | 2201-000146                 | C-CERAMIC,DISC;0.1nF,5%,50V,SL,TP,5x3.5  | ...4     | EY04     | AA60-40011A                 | EYELET;ID2.0,OD2.8,-,BST,                 |
| ...4     | CS801    | 2301-000356                 | C-FILM,PEF;47nF,5%,50V,TP,7.5x4.0x6.5,5m | ...4     | EY05     | AA60-40011A                 | EYELET;ID2.0,OD2.8,-,BST,                 |
| ...4     | CS802    | 2401-000480                 | C-AL;10uF,20%,50V,GP,TP,5x11,5           | ...4     | EY06     | AA60-40011A                 | EYELET;ID2.0,OD2.8,-,BST,                 |
| ...4     | CS803    | 2401-001192                 | C-AL;33uF,20%,50V,GP,TP,6.3x11,5         | ...4     | EY07     | AA60-40011A                 | EYELET;ID2.0,OD2.8,-,BST,                 |
| ...4     | CS804    | 2201-000119                 | C-CERAMIC,DISC;100nF,+80-20%,50V,Y5V,TP, | ...4     | EY08     | AA60-40011A                 | EYELET;ID2.0,OD2.8,-,BST,                 |
| ...4     | CS807    | 2401-001655                 | C-AL;680uF,20%,25V,GP,TP,10x20,5         | ...4     | EY09     | AA60-40011A                 | EYELET;ID2.0,OD2.8,-,BST,                 |
| ...4     | CS808    | 2401-002463                 | C-AL;470uF,20%,16V,GP,TP,8x11.5,5        | ...4     | EY10     | AA60-40011A                 | EYELET;ID2.0,OD2.8,-,BST,                 |
| ...4     | CS809    | 2201-000119                 | C-CERAMIC,DISC;100nF,+80-20%,50V,Y5V,TP, | ...4     | EY100    | AA60-40011A                 | EYELET;ID2.0,OD2.8,-,BST,                 |
| ...4     | D301     | 0401-000005                 | DIODE-SWITCHING;1N4148,100V,200mA,DO-35, | ...4     | EY101    | AA60-40011A                 | EYELET;ID2.0,OD2.8,-,BST,                 |
| ...4     | D302     | 0402-000546                 | DIODE-RECTIFIER;TVR10G,400V,1.0A,DO-41,T | ...4     | EY102    | AA60-40011A                 | EYELET;ID2.0,OD2.8,-,BST,                 |
| ...4     | D384     | 0402-000132                 | DIODE-RECTIFIER;1N4004,400V,1A,DO-41,TP  | ...4     | EY103    | AA60-40011A                 | EYELET;ID2.0,OD2.8,-,BST,                 |
| ...4     | D385     | 0401-000005                 | DIODE-SWITCHING;1N4148,100V,200mA,DO-35, | ...4     | EY104    | AA60-40011A                 | EYELET;ID2.0,OD2.8,-,BST,                 |
| ...4     | D433     | 0402-000537                 | DIODE-RECTIFIER;RH1A,600V,0.6A,DO-204AC  | ...4     | EY105    | AA60-40011A                 | EYELET;ID2.0,OD2.8,-,BST,                 |
| ...4     | D435     | 0402-000132                 | DIODE-RECTIFIER;1N4004,400V,1A,DO-41,TP  | ...4     | EY106    | AA60-40011A                 | EYELET;ID2.0,OD2.8,-,BST,                 |
| ...4     | D436     | 0401-000005                 | DIODE-SWITCHING;1N4148,100V,200mA,DO-35, | ...4     | EY107    | AA60-40011A                 | EYELET;ID2.0,OD2.8,-,BST,                 |
| ...4     | D440     | 0402-000534                 | DIODE-RECTIFIER;RG10V,400V,1.2A,DO-201,T | ...4     | EY108    | AA60-40011A                 | EYELET;ID2.0,OD2.8,-,BST,                 |
| ...4     | D441     | 0402-000534                 | DIODE-RECTIFIER;RG10V,400V,1.2A,DO-201,T | ...4     | EY109    | AA60-40011A                 | EYELET;ID2.0,OD2.8,-,BST,                 |
| ...4     | D442     | 0401-000005                 | DIODE-SWITCHING;1N4148,100V,200mA,DO-35, | ...4     | EY11     | AA60-40011A                 | EYELET;ID2.0,OD2.8,-,BST,                 |
| ...4     | D443     | 0401-000005                 | DIODE-SWITCHING;1N4148,100V,200mA,DO-35, | ...4     | EY111    | AA60-40011A                 | EYELET;ID2.0,OD2.8,-,BST,                 |
| ...4     | D445     | 0402-000534                 | DIODE-RECTIFIER;RG10V,400V,1.2A,DO-201,T | ...4     | EY113    | AA60-40011A                 | EYELET;ID2.0,OD2.8,-,BST,                 |
| ...4     | D451     | 0402-000534                 | DIODE-RECTIFIER;RG10V,400V,1.2A,DO-201,T | ...4     | EY114    | AA60-40011A                 | EYELET;ID2.0,OD2.8,-,BST,                 |
| ...4     | D453     | 0402-001286                 | DIODE-RECTIFIER;RP1H,2000V,-1A,-,TP      | ...4     | EY115    | AA60-40011A                 | EYELET;ID2.0,OD2.8,-,BST,                 |
| ...4     | D472     | 0402-000546                 | DIODE-RECTIFIER;TVR10G,400V,1.0A,DO-41,T | ...4     | EY116    | AA60-40011A                 | EYELET;ID2.0,OD2.8,-,BST,                 |
| ...4     | D474     | 0402-000546                 | DIODE-RECTIFIER;TVR10G,400V,1.0A,DO-41,T | ...4     | EY117    | AA60-40011A                 | EYELET;ID2.0,OD2.8,-,BST,                 |
| ...4     | D477     | 0401-000005                 | DIODE-SWITCHING;1N4148,100V,200mA,DO-35, | ...4     | EY118    | AA60-40011A                 | EYELET;ID2.0,OD2.8,-,BST,                 |
| ...4     | D478     | 0401-000005                 | DIODE-SWITCHING;1N4148,100V,200mA,DO-35, | ...4     | EY119    | AA60-40011A                 | EYELET;ID2.0,OD2.8,-,BST,                 |
| ...4     | D479     | 0401-000005                 | DIODE-SWITCHING;1N4148,100V,200mA,DO-35, | ...4     | EY12     | AA60-40011A                 | EYELET;ID2.0,OD2.8,-,BST,                 |
| ...4     | D480     | 0402-000132                 | DIODE-RECTIFIER;1N4004,400V,1A,DO-41,TP  | ...4     | EY120    | AA60-40011A                 | EYELET;ID2.0,OD2.8,-,BST,                 |
| ...4     | D484     | 0402-000132                 | DIODE-RECTIFIER;1N4004,400V,1A,DO-41,TP  | ...4     | EY121    | AA60-40011A                 | EYELET;ID2.0,OD2.8,-,BST,                 |
| ...4     | D501     | 0402-000132                 | DIODE-RECTIFIER;1N4004,400V,1A,DO-41,TP  | ...4     | EY122    | AA60-40011A                 | EYELET;ID2.0,OD2.8,-,BST,                 |
| △        | D843     | 0402-000546                 | DIODE-RECTIFIER;TVR10G,400V,1.0A,DO-41,T | ...4     | EY123    | AA60-40011A                 | EYELET;ID2.0,OD2.8,-,BST,                 |
| △        | D857     | 0402-000132                 | DIODE-RECTIFIER;1N4004,400V,1A,DO-41,TP  | ...4     | EY124    | AA60-40011A                 | EYELET;ID2.0,OD2.8,-,BST,                 |
| △        | DR401S   | 0401-000005                 | DIODE-SWITCHING;1N4148,100V,200mA,DO-35, | ...4     | EY125    | AA60-40011A                 | EYELET;ID2.0,OD2.8,-,BST,                 |
| △        | DR402S   | 0401-000005                 | DIODE-SWITCHING;1N4148,100V,200mA,DO-35, | ...4     | EY126    | AA60-40011A                 | EYELET;ID2.0,OD2.8,-,BST,                 |
| △        | DR404S   | 0403-001325                 | DIODE-ZENER;MTZJ15C,14.35-15.09V,500mW,D | ...4     | EY127    | AA60-40011A                 | EYELET;ID2.0,OD2.8,-,BST,                 |
| ...4     | DS801    | 0402-000254                 | DIODE-RECTIFIER;RGP10J,600V,1A,DO-41,TP  | ...4     | EY128    | AA60-40011A                 | EYELET;ID2.0,OD2.8,-,BST,                 |
| ...4     | DS802    | 0401-000006                 | DIODE-SWITCHING;BAV21,250V,250mA,DO-35,T | ...4     | EY129    | AA60-40011A                 | EYELET;ID2.0,OD2.8,-,BST,                 |
| ...4     | DS804    | 0401-000006                 | DIODE-SWITCHING;BAV21,250V,250mA,DO-35,T | ...4     | EY13     | AA60-40011A                 | EYELET;ID2.0,OD2.8,-,BST,                 |
| ...4     | DS805    | 0404-001056                 | DIODE-SCHOTTKY;RK16,60V,1.5A,DO-204AC,TP | ...4     | EY130    | AA60-40011A                 | EYELET;ID2.0,OD2.8,-,BST,                 |
| ...4     | DZ301    | 0403-001327                 | DIODE-ZENER;MTZJ18A,16.22-17.06V,500mW,D | ...4     | EY131    | AA60-40011A                 | EYELET;ID2.0,OD2.8,-,BST,                 |
| ...4     | DZ304    | 0403-001327                 | DIODE-ZENER;MTZJ18A,16.22-17.06V,500mW,D | ...4     | EY132    | AA60-40011A                 | EYELET;ID2.0,OD2.8,-,BST,                 |
| ...4     | DZ305    | 0403-001329                 | DIODE-ZENER;MTZJ24B,22.61-23.77V,500mW,D | ...4     | EY133    | AA60-40011A                 | EYELET;ID2.0,OD2.8,-,BST,                 |
| ...4     | DZ306    | 0403-001330                 | DIODE-ZENER;MTZJ30A,26.99-28.39V,500mW,D | ...4     | EY134    | AA60-40011A                 | EYELET;ID2.0,OD2.8,-,BST,                 |
| ...4     | DZ307    | 0403-001329                 | DIODE-ZENER;MTZJ24B,22.61-23.77V,500mW,D | ...4     | EY135    | AA60-40011A                 | EYELET;ID2.0,OD2.8,-,BST,                 |
| ...4     | DZ386    | 0403-001316                 | DIODE-ZENER;MTZJ3.0A,2.85-3.07V,500mW,DO | ...4     | EY136    | AA60-40011A                 | EYELET;ID2.0,OD2.8,-,BST,                 |
| ...4     | DZ395    | 0403-001319                 | DIODE-ZENER;MTZJ4.7C,4.68-4.93V,500mW,DO | ...4     | EY137    | AA60-40011A                 | EYELET;ID2.0,OD2.8,-,BST,                 |
| ...4     | DZ400    | 0403-001325                 | DIODE-ZENER;MTZJ15C,14.35-15.09V,500mW,D | ...4     | EY138    | AA60-40011A                 | EYELET;ID2.0,OD2.8,-,BST,                 |
| ...4     | DZ413    | 0403-001319                 | DIODE-ZENER;MTZJ4.7C,4.68-4.93V,500mW,DO | ...4     | EY139    | AA60-40011A                 | EYELET;ID2.0,OD2.8,-,BST,                 |
| ...4     | DZ473    | 0403-000720                 | DIODE-ZENER;MTZJ9.1B,9.1V,8.57-9.01V,500 | ...4     | EY14     | AA60-40011A                 | EYELET;ID2.0,OD2.8,-,BST,                 |
| ...4     | DZ474    | 0403-000734                 | DIODE-ZENER;TZP15B,15V,14.7-16.5V,1W,DO- | ...4     | EY140    | AA60-40011A                 | EYELET;ID2.0,OD2.8,-,BST,                 |
| ...4     | DZ481    | 0403-001327                 | DIODE-ZENER;MTZJ18A,16.22-17.06V,500mW,D | ...4     | EY141    | AA60-40011A                 | EYELET;ID2.0,OD2.8,-,BST,                 |
| △        | DZ482S   | 0403-000720                 | DIODE-ZENER;MTZJ9.1B,9.1V,8.57-9.01V,500 | ...4     | EY142    | AA60-40011A                 | EYELET;ID2.0,OD2.8,-,BST,                 |





| Loc. No. | Code No.          | Description ; Specification              | Remark |
|----------|-------------------|--|--------|
| ...      | AA67-00185A       | LENS-PLATE;SSM-65,SHADING PLATE          |        |
| ...      | AA61-00056B       | BRACKET-LENS;PROJECTION,SECC,T1.6,-,-,-  | S.N.A  |
| ...      | AA39-00018A       | LEAD CONNECTOR-ASSY;UL1015#22,UL/CSA,1P  |        |
| ...      | AA26-30006F       | TRANS-FLYBACK;-FWZ-50A001C,55',30KV      |        |
| ...      | AA03-00200A       | CDT MONO;P16LSG03RJA,FREE,3.30mH,2.20mH, |        |
| ...      | AA60-00127B       | SPACER-LENS;PROJ,SILICONE,D/GRAY         | S.N.A  |
| ...      | AA60-00126B       | SPACER-CAP;PROJ,EPDM,BLK                 | S.N.A  |
| ...      | AA60-00125B       | SPACER-CRT;PROJ,SILICONE,D/GRAY          | S.N.A  |
| ...      | AA60-00074A       | SPACER-DY;PJT,SILICON RUBBER,-,-,-,GRAY, | S.N.A  |
| ..2      | BP91-00257A       | ASSY CPT-G;HCM4215WX/XAA,P55A,DELTA71,GR |        |
| ...      | BC+AL AA60-10011A | SCREW-TAPTITE;-SWRCH18A,M4,L12,HH,+PC,   | S.N.A  |
| ...      | AA63-00076A       | SPACER-LENS;PROJECTION,FELT,-,-,-,BROWN  | S.N.A  |
| ...      | AA61-00810B       | HOLDER-CAP;PROJ,PC,CLR                   | S.N.A  |
| ...      | AA61-00809B       | HOLDER-CRT;PROJ,PC/ABS GF 20%,BLK        | S.N.A  |
| ...      | AA61-00807B       | CASE-COUPLER,G;PROJ,ALDC,T8,BLK          | S.N.A  |
| ...      | AA61-00056B       | BRACKET-LENS;PROJECTION,SECC,T1.6,-,-,-  | S.N.A  |
| ...      | AA27-00249A       | DEFLECTION YOKE;-DPD-5292AA,S/S,7,29.1   |        |
| ...      | AA91-00722A       | ASSY-BRKT,CRT;SECC T1.6,PROJ             |        |
| ...      | AA61-00473B       | BRACKET-CRT;53,SECC,T1.6,-,-,-           | S.N.A  |
| ...      | AA61-00615B       | BRACKET-EARTH;54J8,PBS,TO.5,-,-,-        | S.N.A  |
| ...      | AA61-00812A       | SPRING-WIRE;PROJ,STS,3.6                 | S.N.A  |
| ...      | AA67-00185A       | LENS-PLATE;SSM-65,SHADING PLATE          |        |
| ...      | AA67-00095A       | LENS;-SSM-65,GREEN,-,-,-,C ELEMENT       |        |
| ...      | AA67-00092A       | LENS-ASSY;-SSM-65,CLEAR A/B,-,-,-        |        |
| ...      | AA39-00018A       | LEAD CONNECTOR-ASSY;UL1015#22,UL/CSA,1P  |        |
| ...      | AA26-30006F       | TRANS-FLYBACK;-FWZ-50A001C,55',30KV      |        |
| ...      | AA03-00201A       | CDT MONO;P16LSG03HKA,FREE,3.30mH,2.20mH, |        |
| ...      | AA60-00127B       | SPACER-LENS;PROJ,SILICONE,D/GRAY         | S.N.A  |
| ...      | AA60-00126B       | SPACER-CAP;PROJ,EPDM,BLK                 | S.N.A  |
| ...      | AA60-00125B       | SPACER-CRT;PROJ,SILICONE,D/GRAY          | S.N.A  |
| ...      | AA60-00074A       | SPACER-DY;PJT,SILICON RUBBER,-,-,-,GRAY, | S.N.A  |
| ..2      | BP91-00258A       | ASSY CPT-B;HCM4215WX/XAA,P55A,DELTA71,BU |        |
| ...      | BC+AL AA60-10011A | SCREW-TAPTITE;-SWRCH18A,M4,L12,HH,+PC,   | S.N.A  |
| ...      | AA67-00093A       | LENS;-SSM-65,CLEAR,-,-,-,C ELEMENT       |        |
| ...      | AA67-00092A       | LENS-ASSY;-SSM-65,CLEAR A/B,-,-,-        |        |
| ...      | AA63-00076A       | SPACER-LENS;PROJECTION,FELT,-,-,-,BROWN  | S.N.A  |
| ...      | AA61-00810B       | HOLDER-CAP;PROJ,PC,CLR                   | S.N.A  |
| ...      | AA61-00808B       | CASE-COUPLER,B;PROJ,ALDC,T8,BLK          | S.N.A  |
| ...      | AA33-00018A       | MAGNET CONVERGENCE;JH 92LT - 36F,-29.1M  |        |
| ...      | AA27-00249A       | DEFLECTION YOKE;-DPD-5292AA,S/S,7,29.1   |        |
| ...      | BP61-00009A       | HOLDER-CRT;42W5,PC/ABS,BLK,GF20%         | S.N.A  |
| ...      | AA91-00722A       | ASSY-BRKT,CRT;SECC T1.6,PROJ             |        |
| ...      | AA61-00473B       | BRACKET-CRT;53,SECC,T1.6,-,-,-           | S.N.A  |
| ...      | AA61-00615B       | BRACKET-EARTH;54J8,PBS,TO.5,-,-,-        | S.N.A  |
| ...      | AA61-00812A       | SPRING-WIRE;PROJ,STS,3.6                 | S.N.A  |
| ...      | AA67-00185A       | LENS-PLATE;SSM-65,SHADING PLATE          |        |
| ...      | AA61-00056B       | BRACKET-LENS;PROJECTION,SECC,T1.6,-,-,-  | S.N.A  |
| ...      | AA39-00018A       | LEAD CONNECTOR-ASSY;UL1015#22,UL/CSA,1P  |        |
| ...      | AA26-30006F       | TRANS-FLYBACK;-FWZ-50A001C,55',30KV      |        |
| ...      | AA03-00202A       | CDT MONO;P16LSG03BMB,FREE,3.30mH,2.20mH, |        |
| ...      | AA60-00128B       | SPACER-CRT;PROJ(65),SILICONE,D/GRAY      | S.N.A  |
| ...      | AA60-00127B       | SPACER-LENS;PROJ,SILICONE,D/GRAY         | S.N.A  |
| ...      | AA60-00126B       | SPACER-CAP;PROJ,EPDM,BLK                 | S.N.A  |
| ...      | AA60-00074A       | SPACER-DY;PJT,SILICON RUBBER,-,-,-,GRAY, | S.N.A  |

**ASSY COVER FRONT**

|     |        |             |  |       |
|-----|--------|-------------|--|-------|
| 1   | *      | BP90-00007N | ASSY COVER FRONT;42W5,HCM422WX/XAA       |       |
| ..2 | AC+BCM | 6003-001339 | SCREW-TAPTITE;HH,+B,M4,L15,ZPC(BLK),SWR  | S.N.A |
| ..2 | BCM+CW | 6006-001094 | SCREW-ASS'Y WOOD;WWW,HH,+M7,L32,ZPC(YEL) | S.N.A |
| ..2 | BF+BCM | AA60-10011A | SCREW-TAPTITE;-SWRCH18A,M4,L12,HH,+PC,   | S.N.A |
| ..2 | BS+CF  | AA60-10011A | SCREW-TAPTITE;-SWRCH18A,M4,L12,HH,+PC,   | S.N.A |
| ..2 | CF+CW  | 6005-001003 | SCREW-WOOD;HH,+M4,L19,ZPC(BLK),SWRCH18A  |       |
| ..2 | CGH+BC | AA60-10011A | SCREW-TAPTITE;-SWRCH18A,M4,L12,HH,+PC,   | S.N.A |
| ..2 | CP+KC  | 6003-001023 | SCREW-TAPTITE,RWH,+B,M3,L10,ZPC(YEL),SW  | S.N.A |
| ..2 | CPC+CW | 6005-001003 | SCREW-WOOD;HH,+M4,L19,ZPC(BLK),SWRCH18A  |       |
| ..2 | HP+BCM | AA60-10011A | SCREW-TAPTITE;-SWRCH18A,M4,L12,HH,+PC,   | S.N.A |
| ..2 | HV+BCM | AA60-10011A | SCREW-TAPTITE;-SWRCH18A,M4,L12,HH,+PC,   | S.N.A |
| ..2 | IS+CW  | 6005-001003 | SCREW-WOOD;HH,+M4,L19,ZPC(BLK),SWRCH18A  |       |
| ..2 |        | BP61-00023B | BRACKET-SCREEN,ASSY(TOP);42W5,SECC,T1.0, | S.N.A |
| ... |        | AA61-01121A | BRACKET-SCREEN,TB;42W5,SECC,T1.0         | S.N.A |
| ... |        | BP61-00052A | HOLDER-WIRE;PJT,V,NYLON,66,NATURAL       | S.N.A |
| ... |        | BP61-00043A | HOLDER-SENSOR;W9,ABS ,HB,BLK             | S.N.A |
| ..2 |        | BP61-00024B | BRACKET-SCREEN,ASSY(BOT);42W5,SECC,T1.0, | S.N.A |

| Loc. No. | Code No.            | Description ; Specification               | Remark                                  |       |
|----------|---------------------|---|---|-------|
| ...      | AA61-01121A         | BRACKET-SCREEN,TB;42W5,SECC,T1.0          | S.N.A                                   |       |
| ...      | AA65-00020A         | CLAMP CORE-WIRE;55W9,NYLON 66             | S.N.A                                   |       |
| ...      | BP61-00043A         | HOLDER-SENSOR;W9,ABS ,HB,BLK              | S.N.A                                   |       |
| ...      | BP61-00052A         | HOLDER-WIRE;PJT,V,NYLON,66,NATURAL        | S.N.A                                   |       |
| ..2      | BP61-00025B         | BRACKET-SCREEN,ASSY(R);42W5,SECC,T1.0,NE  | S.N.A                                   |       |
| ...      | AA61-01121A         | BRACKET-SCREEN,TB;42W5,SECC,T1.0          | S.N.A                                   |       |
| ...      | BP61-00043A         | HOLDER-SENSOR;W9,ABS ,HB,BLK              | S.N.A                                   |       |
| ...      | BP61-00052A         | HOLDER-WIRE;PJT,V,NYLON,66,NATURAL        | S.N.A                                   |       |
| ..2      | BP61-00026B         | BRACKET-SCREEN,ASSY(L);42W5,SECC,T1.0,NE  | S.N.A                                   |       |
| ...      | AA61-01121A         | BRACKET-SCREEN,TB;42W5,SECC,T1.0          | S.N.A                                   |       |
| ...      | BP61-00043A         | HOLDER-SENSOR;W9,ABS ,HB,BLK              | S.N.A                                   |       |
| ...      | BP61-00052A         | HOLDER-WIRE;PJT,V,NYLON,66,NATURAL        | S.N.A                                   |       |
| ...      | BP64-00029A         | INLAY-SUPPORT;42W5,PS SHEET,TO.5,94V0     |   |       |
| ...      | BP91-00005D         | ASSY-CABINET,WOOD;WOOD,MIJU,42W5          | S.N.A                                   |       |
| ...      | SPK+CVW AA60-10051A | SCREW-WOOD;-SWRCH18A,M4,L16,PH,+,-,-,ZP   | S.N.A                                   |       |
| ...      | AA61-00508D         | HOLDER-JERSEY;W3,54,62J8,SECC-1 ,TO.5,-   | S.N.A                                   |       |
| ...      | AA61-00533B         | BRACKET-GRILLE;43,54,62J8,SECC-1 ,TO.5,-  | S.N.A                                   |       |
| ...      | AA64-02724A         | CABINET-WOOD;42W5,WOOD,SDE8336R           | S.N.A                                   |       |
| ...      | AA98-00049A         | ASSY-LEAD,CON;-LEAD-CON,CORE,AA39-20505   | S.N.A                                   |       |
| ...      | 3301-001201         | CORE-FERRITE;AE,21x11x32mm,1500,280G      |   |       |
| ...      | BP61-00019A         | HOLDER-PALLET;42W5,HIPS ,HB,BLK           | S.N.A                                   |       |
| ...      | BP61-00035A         | BRACKET-GRILLE;42W5,SECC-1,T1.0           | S.N.A                                   |       |
| ...      | AA61-00506B         | HOLDER-CRT,MAIN;43,54,62J8,HIPS,-,-,-,BL  | S.N.A                                   |       |
| ...      | 3001-000279         | SPEAKER;30W,8ohm,91dB,20Hz                |   |       |
| ...      | 3001-001107         | SPEAKER;20W,8ohm,95dB,1300Hz              |   |       |
| ...      | AA39-00086A         | LEAD CONNECTOR-ASSY;2,ZUF,REC,REC,200MM   |   |       |
| ...      | AA61-00094G         | HOLDER-RAIL;42W5,ABS ,HB,L480,BLK,2HOLE   | S.N.A                                   |       |
| ...      | AA61-00097A         | HOLDER-WIRE;-NYLON 6/6,-,-,-,NTR,-        | S.N.A                                   |       |
| ...      | BP91-00008D         | ASSY-PANNEL,CONTROL;HIPS ,HB,G4309,SVM11  |   |       |
| ...      | 6003-001026         | SCREW-TAPTITE;RH,+B,M4,L15,ZPC(BLK),SWR   |   |       |
| ...      | KC+CPC VC+CPC       | 6003-001019                               | SCREW-TAPTITE;RH,+B,M4,L12,ZPC(BLK),SWR | S.N.A |
| ...      | Z                   | 6003-001019                               | SCREW-TAPTITE;RH,+B,M4,L12,ZPC(BLK),SWR | S.N.A |
| ...      | AA64-02726A         | CABINET-PANEL,CONTROL;42W5,HIPS,HB,G4309  | S.N.A                                   |       |
| ...      | AA64-02739A         | KNOB-CONTROL;42W5,ABS,HB,G3676,COT        |   |       |
| ...      | AA64-02740A         | KNOB-POWVER;42W5,ABS,HB,G3676,COT         |   |       |
| ...      | AA64-02742A         | WINDOW-RMC,LED;42W5,PC,CLR                | S.N.A                                   |       |
| ...      | BP64-00035D         | INLAY-DECORATION;42W5,AL,TO.4,MIJU        |   |       |
| ...      | AA61-01130A         | GUIDE-KNOB,CONTROL;42W5,ABS ,HB,G3676,SVM | S.N.A                                   |       |
| ...      | AA61-01132A         | VELCRO-A;COMMANDO,BST1 1/4H               | S.N.A                                   |       |
| ...      | AA61-01133A         | VELCRO-B;COMMANDO,BST1 1/4H               | S.N.A                                   |       |
| ...      | AA61-20129A         | HOLDER-WIRE;-NYLON-66,-,-,-,NTR,DAFC-25   | S.N.A                                   |       |
| ...      | AA61-60003J         | SPRING-CS;-SUS304,-,-,OD6,N7,OD6,-,-,-    | S.N.A                                   |       |
| ..2      | BP91-00007F         | ASSY-FRONT,BOT;HIPS ,HB,G4309,SVM1132+SV  |   |       |
| ...      | VC+CFB              | 6003-001019                               | SCREW-TAPTITE;RH,+B,M4,L12,ZPC(BLK),SWR | S.N.A |
| ...      | BP73-00001A         | RUBBER-SHEET;42W5,NBB RUBBER,GRAY,10*20   |   |       |
| ...      | AA64-02743A         | BADGE-DECORATION;42W5,AL,NIRS             |   |       |
| ...      | AA64-02725F         | CABINET-FRONT,BOT;42W5,HIPS,V0,G4309,SVM  | S.N.A                                   |       |
| ...      | AA61-01132A         | VELCRO-A;COMMANDO,BST1 1/4H               | S.N.A                                   |       |
| ...      | BP91-00006F         | ASSY-FRONT,MASK;HIPS ,HB,G4309,SVM1132,T  |   |       |
| ...      | AA64-02727F         | CABINET-FRONT,MASK TOP;42W5,HIPS,HB,G430  |   |       |
| ...      | AA64-02211E         | BADGE-BRAND ;72MM,AL FORGING,SVM1132,SAMS | S.N.A                                   |       |
| ...      | AA61-01133A         | VELCRO-B;COMMANDO,BST1 1/4H               | S.N.A                                   |       |
| ...      | 6003-001019         | SCREW-TAPTITE;RH,+B,M4,L12,ZPC(BLK),SWR   | S.N.A                                   |       |
| ..2      | BP39-00009A         | LEAD CONNECTOR ASSY;P54A/SVP-42W5,UL2547  |   |       |
| ..2      | AA26-00101A         | TRANS FBT;FWZ50A001E/FFA97513B,12KV,5P-   |   |       |
| ..2      | AA60-00072B         | SPACER-COVER,DUST;43,54,62J9,SPONGE 94HF  | S.N.A                                   |       |
| ..2      | AA61-00475B         | BRACKET-CRT,MAIN;54,SECC,T1.6,-,-,-       | S.N.A                                   |       |
| ..2      | AA67-00193A         | SCREEN-TINT;42W,958*550,T=0.73,P=052      |   |       |
| ..2      | AA67-00193B         | SCREEN-FRESNEL;42W,960*552,T=2,0          |   |       |
| ..2      | AA67-00207A         | SCREEN-FILTER;T=82%,960*552*2,G=110,AG    |   |       |
| ..2      | AA73-00005B         | RUBBER-CAP;FLAT,PRJ,SILICONE RUBBER,WHIT  |   |       |

**ASSY COVER REAR**

|     |         |             |   |       |
|-----|---------|-------------|---|-------|
| 1   | *       | BP90-00008F | ASSY COVER REAR;42W5,MIJU,422W          |       |
| ..2 | BM+CBT  | 6003-001026 | SCREW-TAPTITE;RH,+B,M4,L15,ZPC(BLK),SWR | S.N.A |
| ..2 | CBB+CB  | 6003-001026 | SCREW-TAPTITE;RH,+B,M4,L15,ZPC(BLK),SWR | S.N.A |
| ..2 | CBT+CF  | 6003-001026 | SCREW-TAPTITE;RH,+B,M4,L15,ZPC(BLK),SWR | S.N.A |
| ..2 | CBT+CP  | 6003-001026 | SCREW-TAPTITE;RH,+B,M4,L15,ZPC(BLK),SWR | S.N.A |
| ..2 | CBT+CVW | 6005-001003 | SCREW-WOOD;HH,+M4,L19,ZPC(BLK),SWRCH18A |       |
| ..2 | HC+CW   | 6005-001003 | SCREW-WOOD;HH,+M4,L19,ZPC(BLK),SWRCH18A |       |
| ..2 | TB+RJK  | 6003-001026 | SCREW-TAPTITE;RH,+B,M4,L15,ZPC(BLK),SWR | S.N.A |
| ..2 | TB+TU   | 6003-001026 | SCREW-TAPTITE;RH,+B,M4,L15,ZPC(BLK),SWR | S.N.A |

| Loc. No.               | Code No.    | Description ; Specification              | Remark                                   | Loc. No. | Code No. | Description ; Specification | Remark |
|------------------------|-------------|--|--|----------|----------|-----------------------------|--------|
| ..2                    | AA65-30008A | CLAMP-CORD;-PE,HB,-,BLK,-                | S.N.A                                    |          |          |                             |        |
| ..2                    | AA67-00204A | MIRROR-FRONT;42W5,FSM,870*633*446        | S.N.A                                    |          |          |                             |        |
| ..2                    | BP61-00008A | BRACKET-MIRROR,ASSY;42W5,SECC,T1.0,01123 | S.N.A                                    |          |          |                             |        |
| ...3                   | AA61-01123A | BRACKET-MIRROR;42W5,SECC,T1.0            | S.N.A                                    |          |          |                             |        |
| ...3                   | BP60-00005A | SPACER-SPONGE;42W5,RUBBER-SPONGE,T3      | S.N.A                                    |          |          |                             |        |
| ..2                    | BP96-00038B | ASSY COVER P-TERMINAL,ANT;42W5,HIPS VO,B | S.N.A                                    |          |          |                             |        |
| ...3                   | AA64-02836A | INLAY-TERMINAL,NT;COMMANDO,PS SHEET,T0.5 | S.N.A                                    |          |          |                             |        |
| ...3                   | AA65-00023A | TERMINAL-BOARD,ANT;,HIPS VO,BLK          | S.N.A                                    |          |          |                             |        |
| ..2                    | AA64-60449B | INLAY-COVER;SP-434JMF,PS,T0.5,149.3X69.5 | S.N.A                                    |          |          |                             |        |
| ..2                    | AA64-60421C | INLAY-COVER;-;PS,T0.3,-,-,BLK,SEA        | S.N.A                                    |          |          |                             |        |
| ..2                    | AA64-02729B | CABINET-BACK,BOT;42W5,HIPS,VO,G4309      | S.N.A                                    |          |          |                             |        |
| ..2                    | AA64-02728A | CABINET-BACK,TOP;42W5,HIPS,HB,G4309      | S.N.A                                    |          |          |                             |        |
| <b>ASSY P/MATERIAL</b> |             |  |  |          |          |                             |        |
| 1                      | *           | BP92-00009A                              | ASSY P/MATERIAL;42W5,SVP-42W5HR          | S.N.A    |          |                             |        |
| ..2                    | AA61-20285A | HOLDER-BOX;3456,PP,-,-,WHT,VO            | S.N.A                                    |          |          |                             |        |
| ..2                    | AA60-40006A | PIN-STAPLE;-,-,H18,33X17.8X2.4,-,AUTO    | S.N.A                                    |          |          |                             |        |
| <b>ASSY LABEL</b>      |             |  |  |          |          |                             |        |
| 1                      | *           | BP92-00058A                              | ASSY LABEL;HCM422WX/XAA,P55A,LABEL,P55A, | S.N.A    |          |                             |        |

**ASSY BOX**

1 \* BP92-00008M ASSY BOX;42W5,HCM422WX/XAA

**ASSY ACCESSORY**

1 \* BP92-00012A ASSY ACCESSORY;HCM4215WX/MVT,P55A S.N.A

..2 BP68-00021A MANUAL USERS;HCM4215W,ENG,W/P100G,P55A,B

..2 AA59-00262A REMOCON;TM63,COMMONDO,48,G6671B,EX,S/S

..2 AA39-00006A CABLE-RCA;3000MM

# MEMO

## 8. Block Diagram

### 8-1 Current System

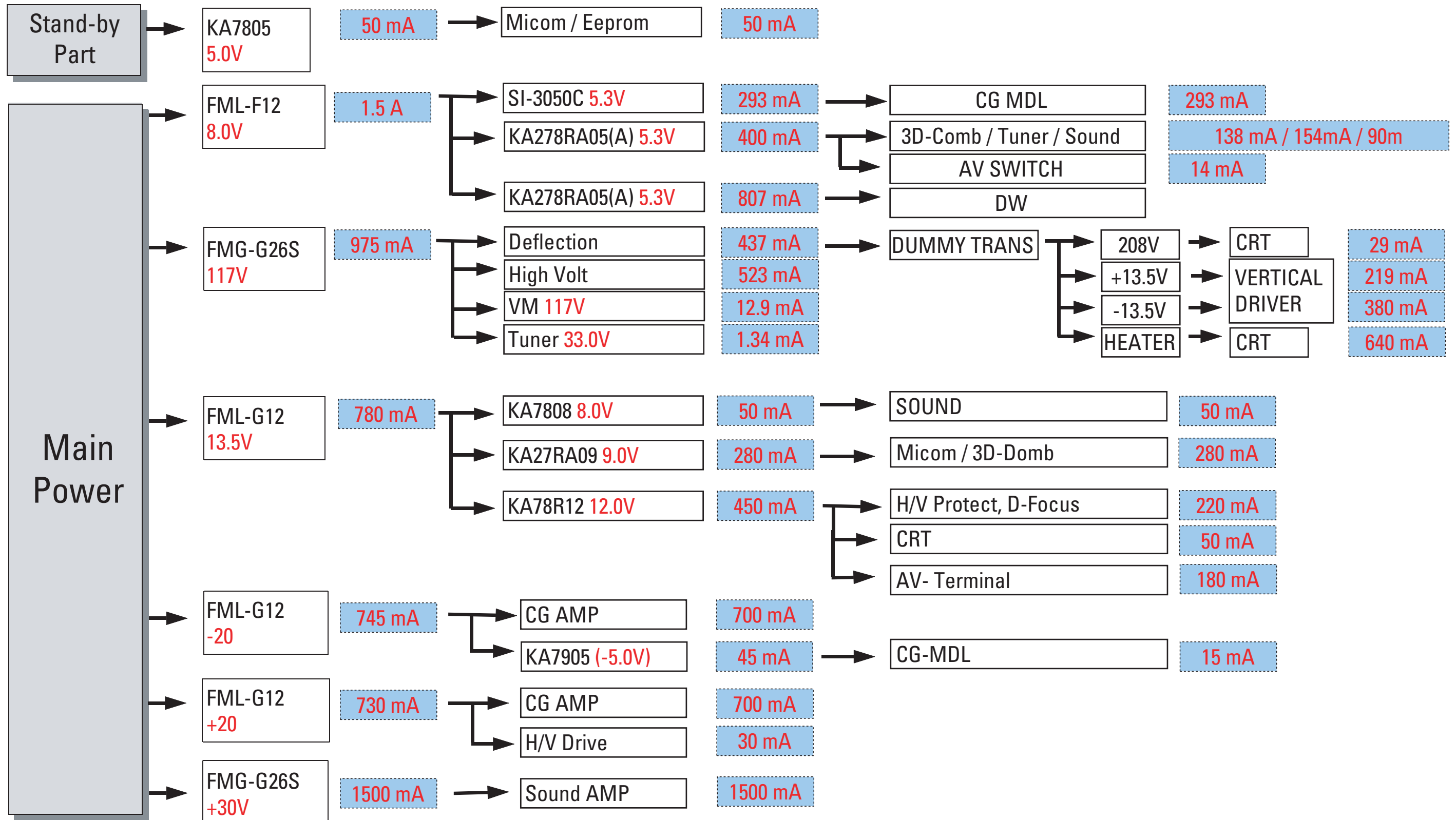

8-2 Power Supply System

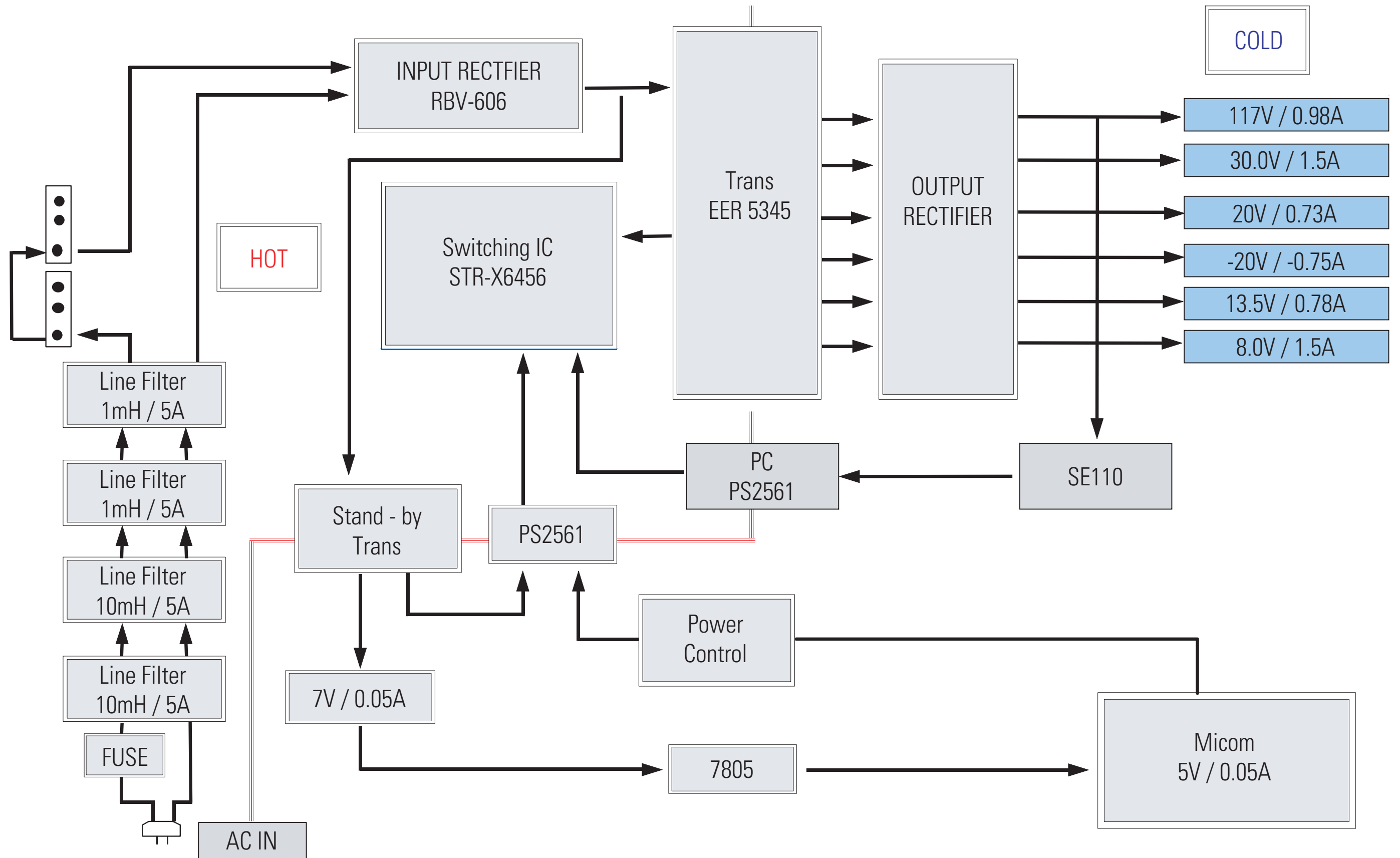



8-3 Deflection System

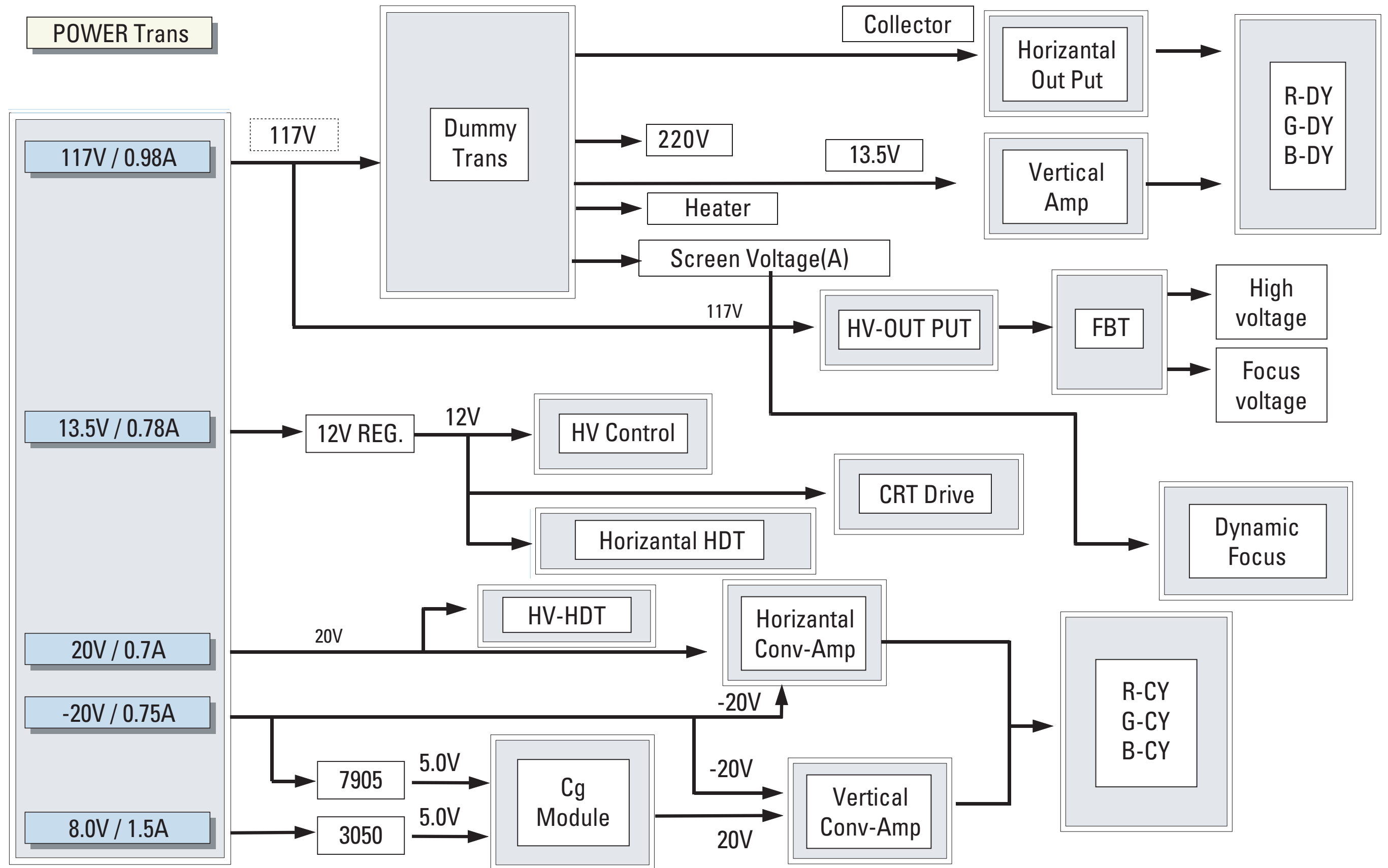

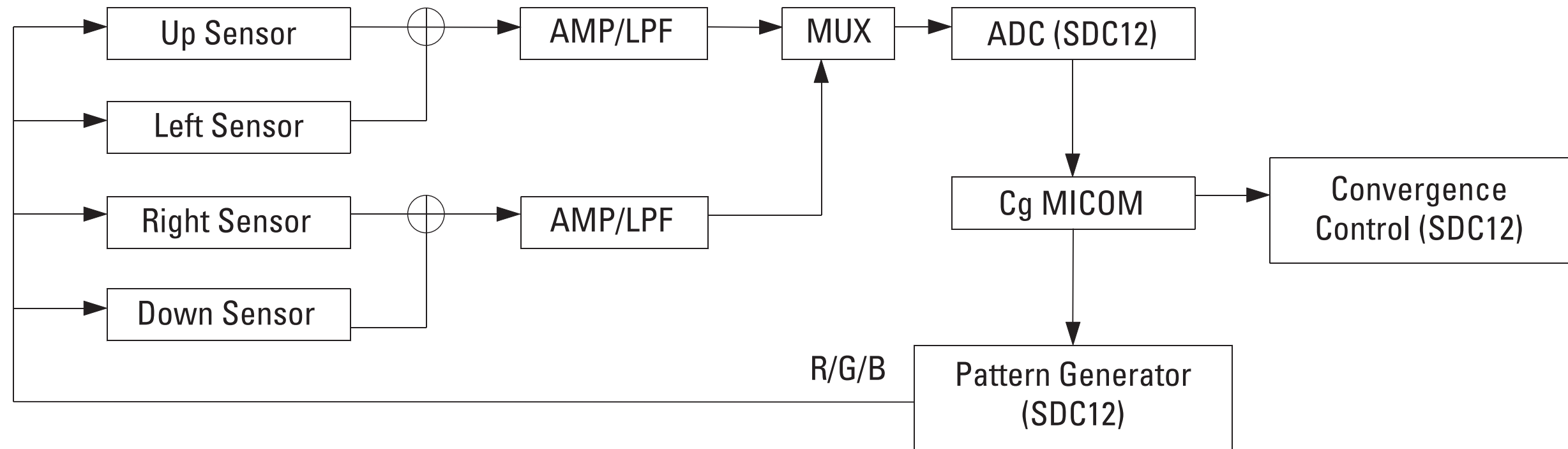
**8-4 SDC Perfect Focus Block Diagram**

8-5 Sound Switching Block Diagram -1

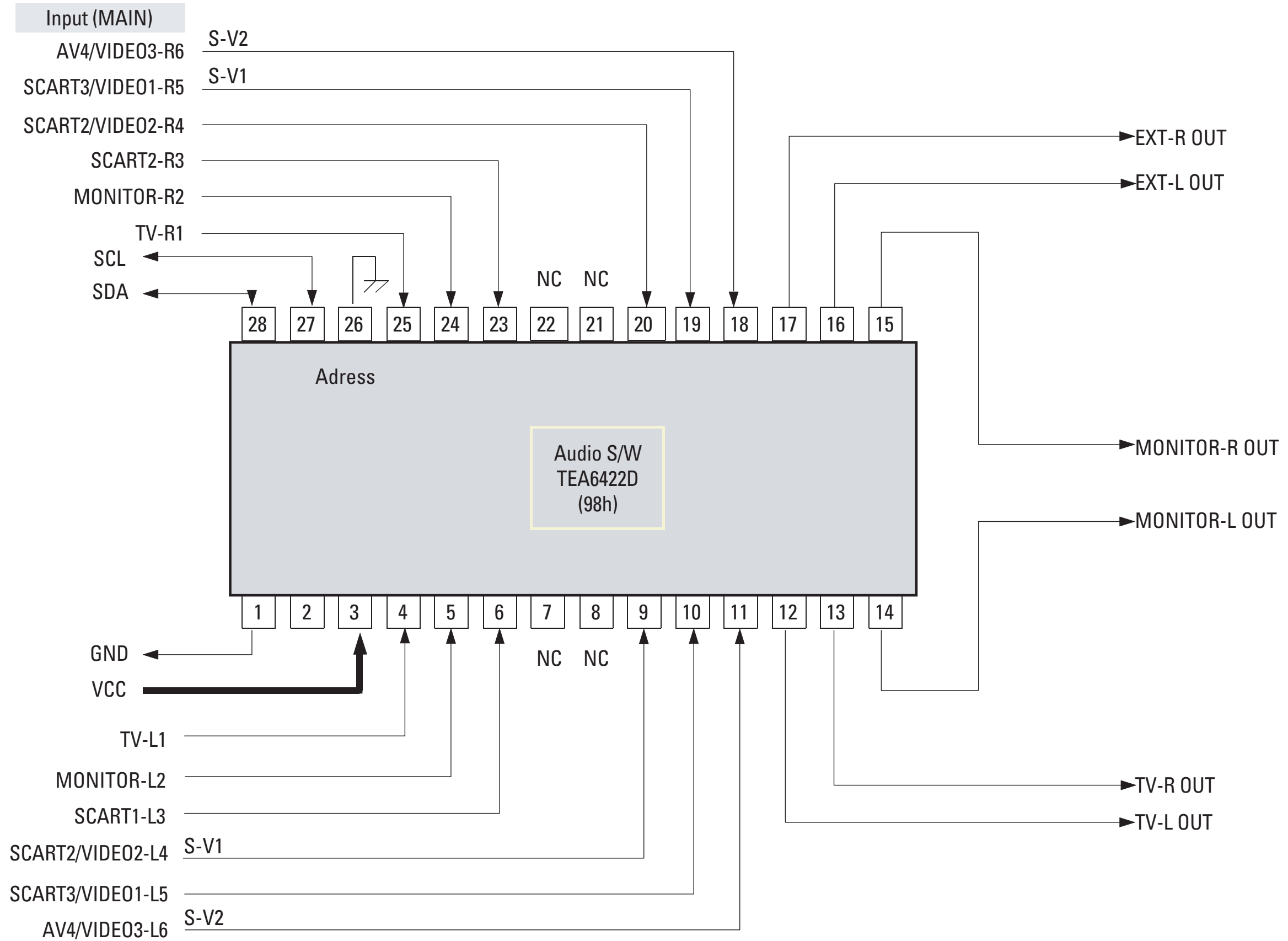

**8-6 Sound Switching Block Diagram -2**

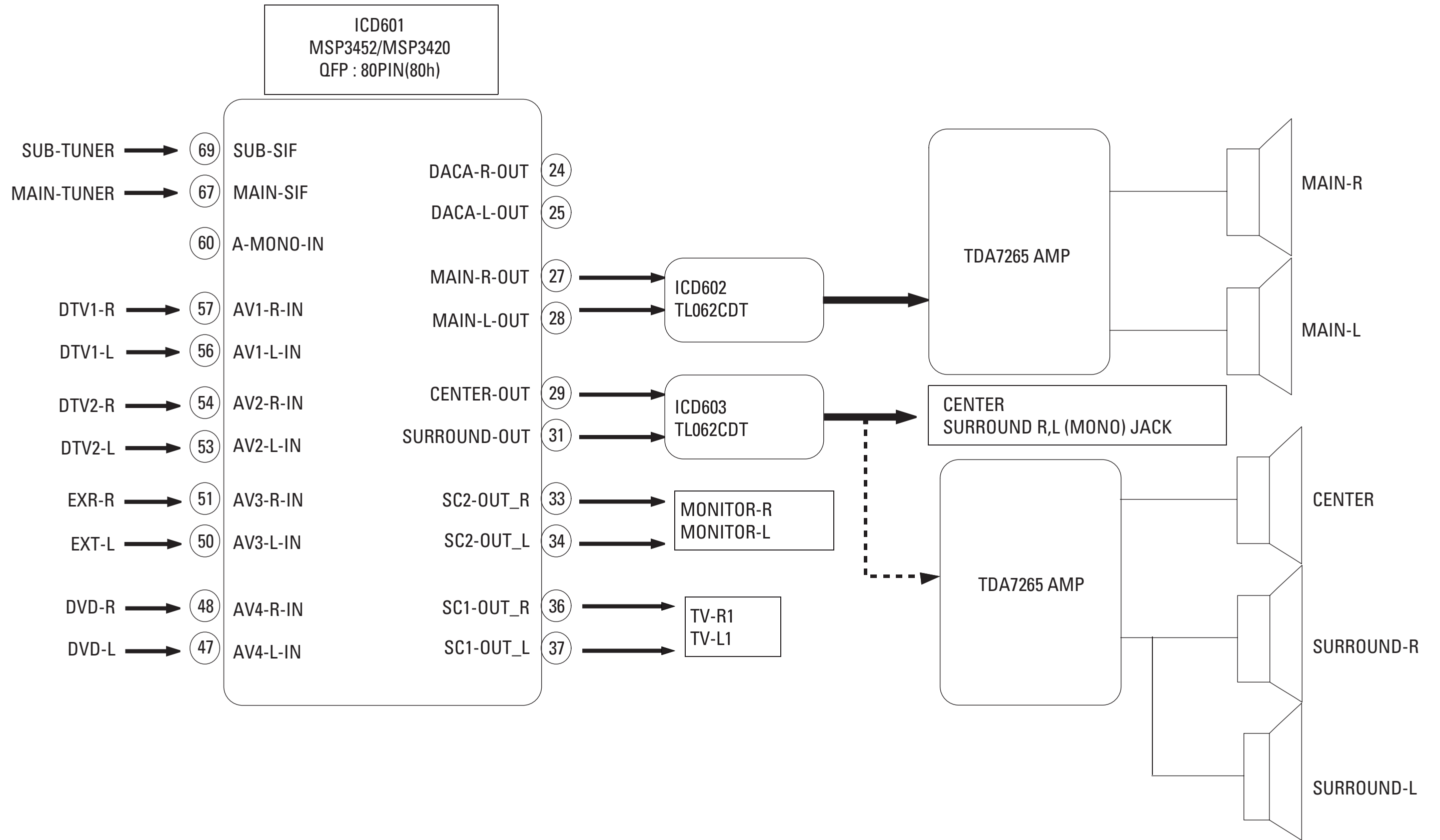

8-7 Video Signal Diagram

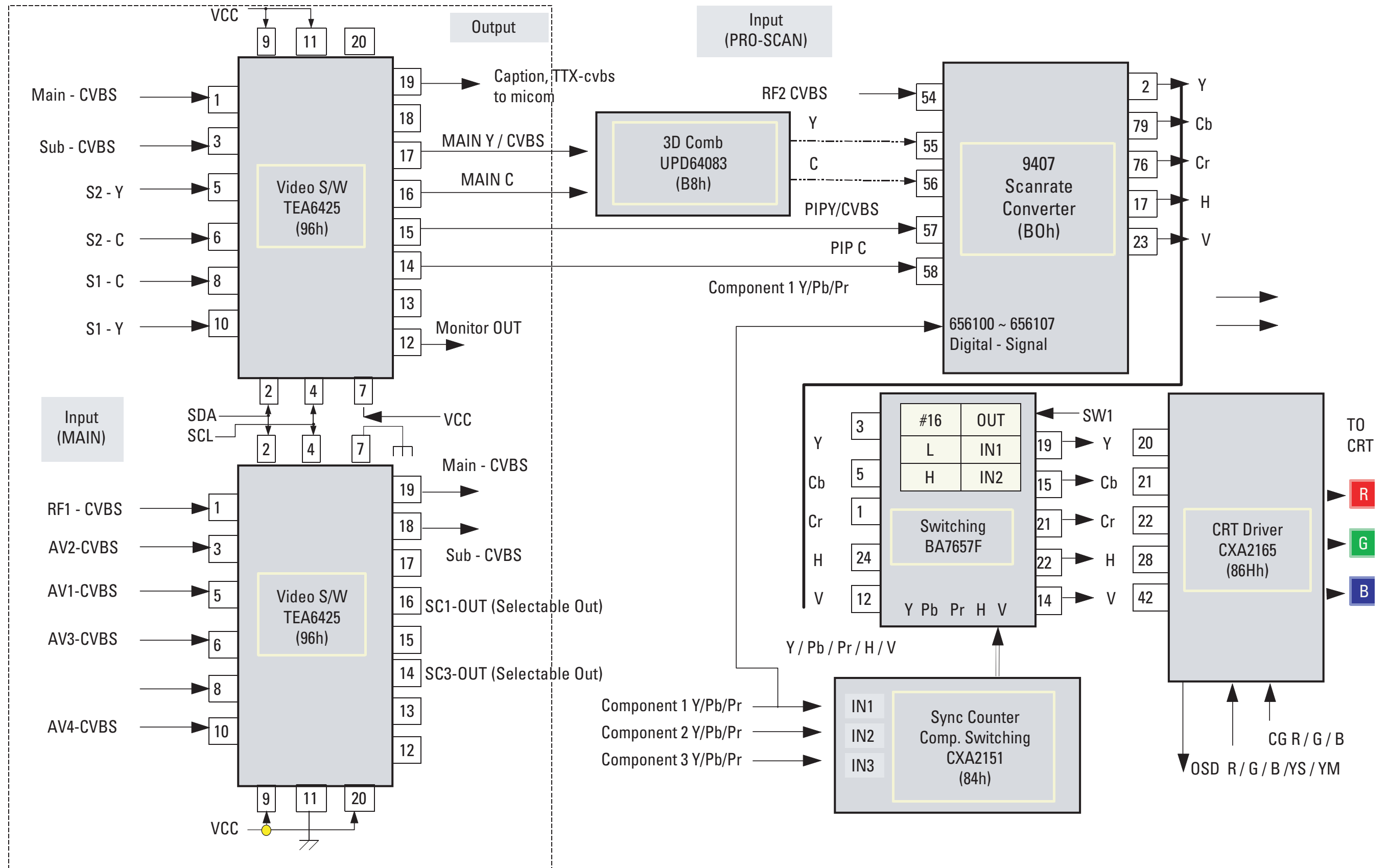

# 9. Wiring Diagram

## 9-1 Pcb Connection

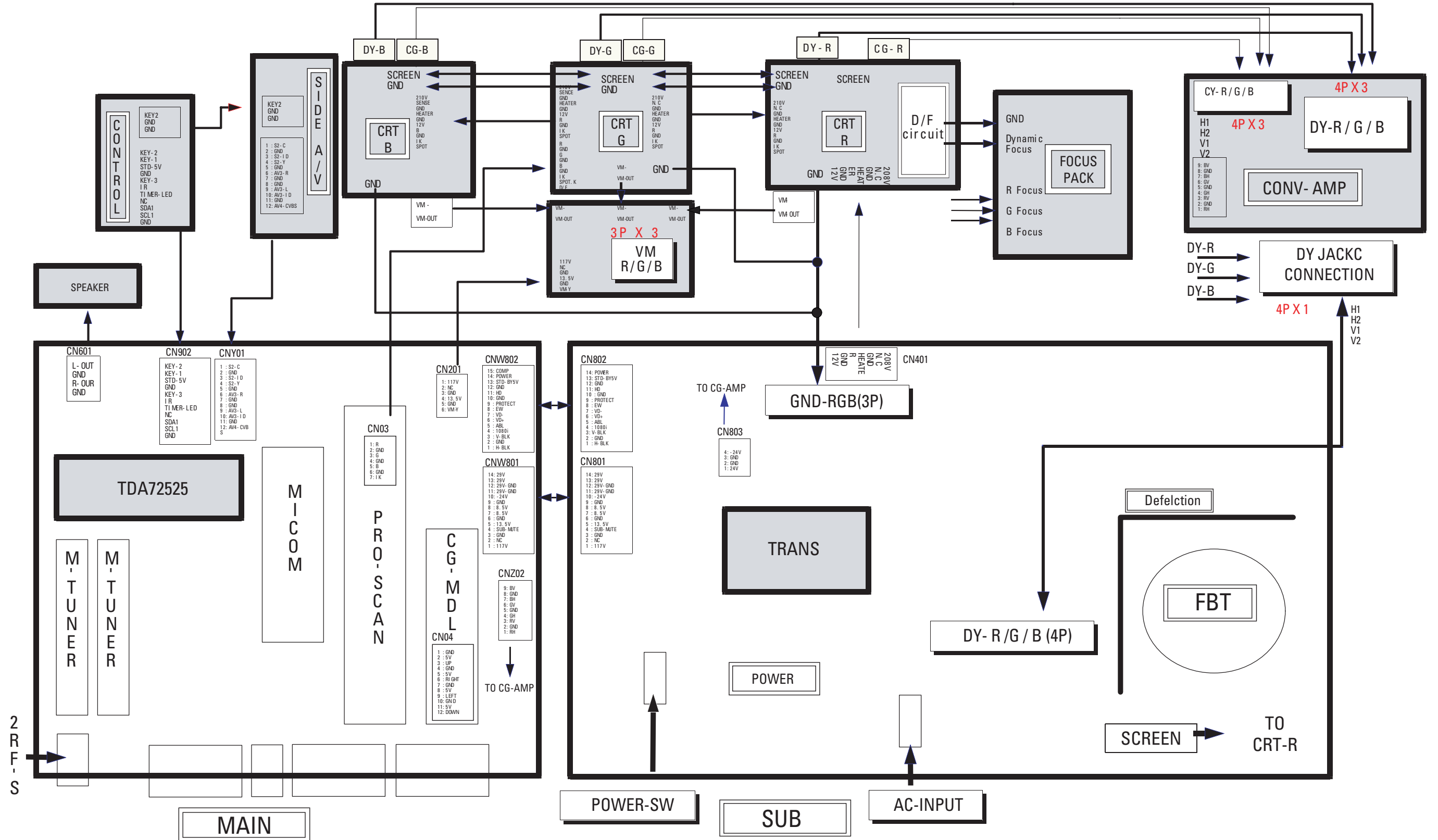

# 10. Schematic Diagrams

## 10-1 MAIN 1

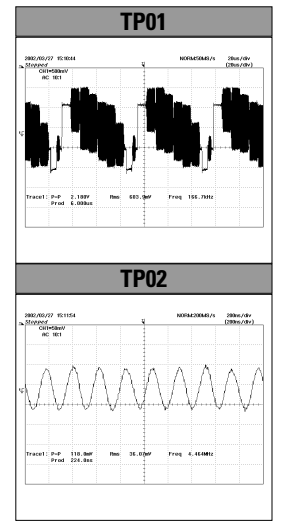
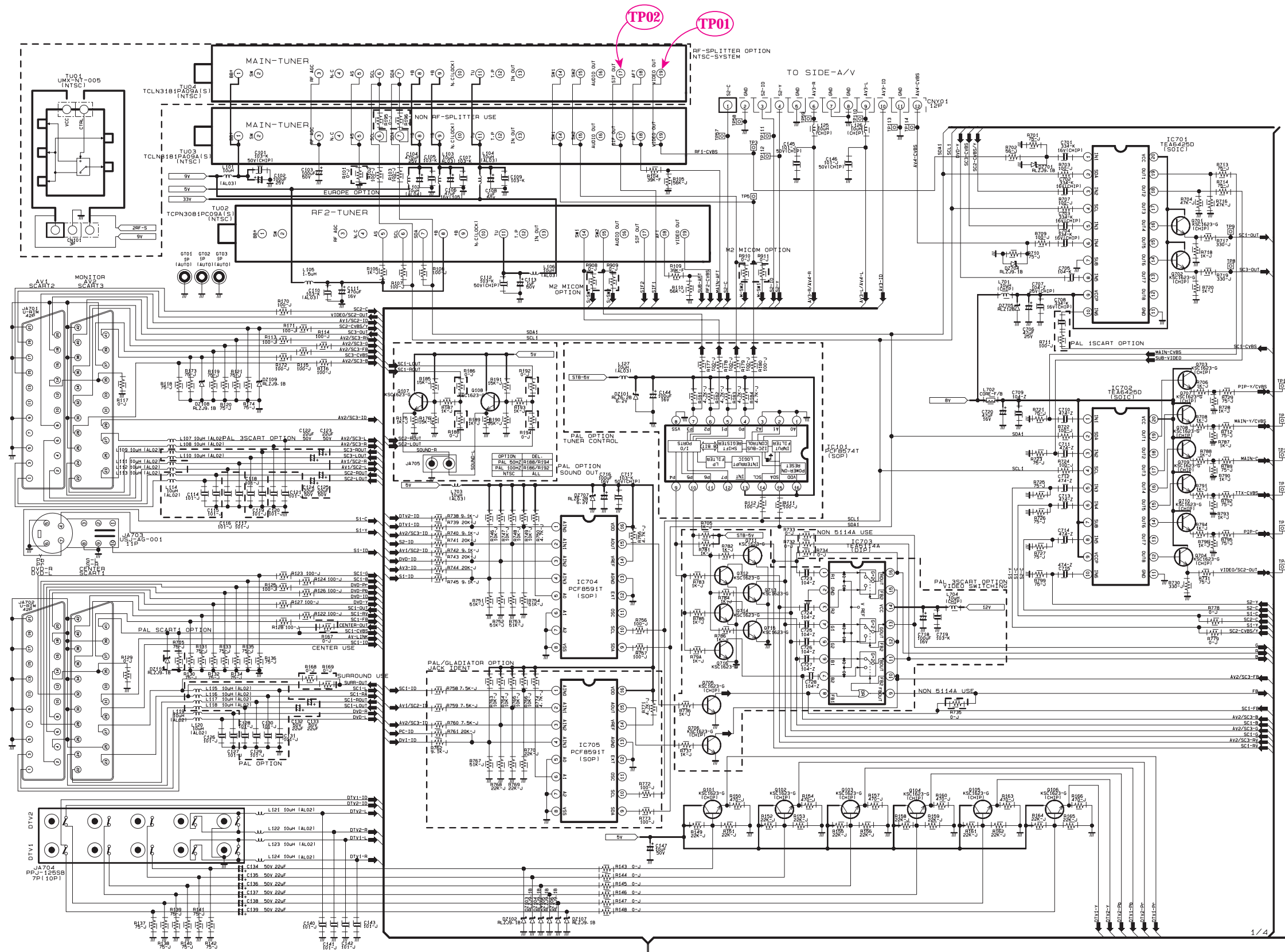

10-2 MAIN 2

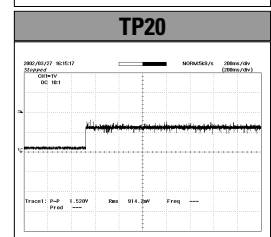
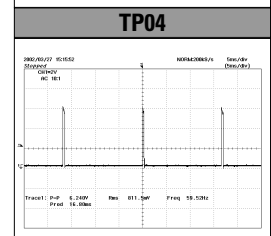
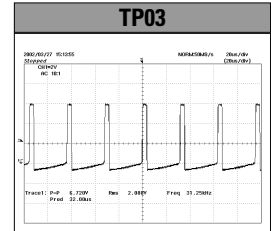
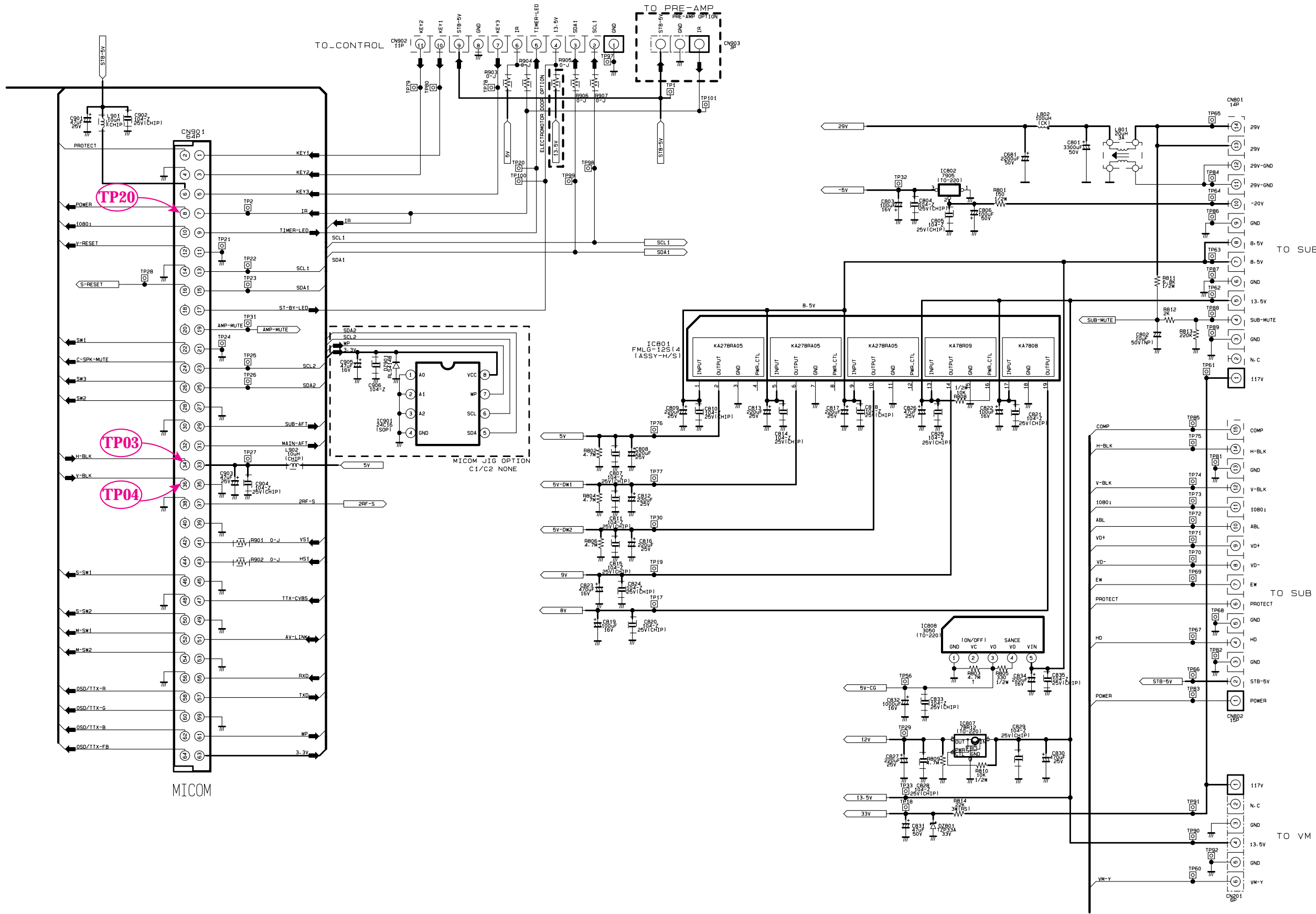



10-3 MAIN 3

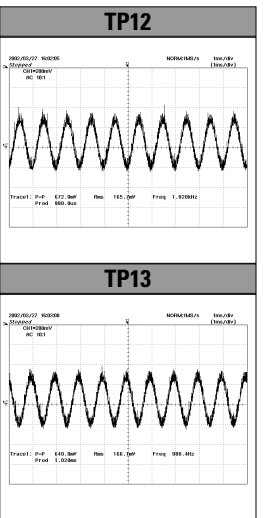
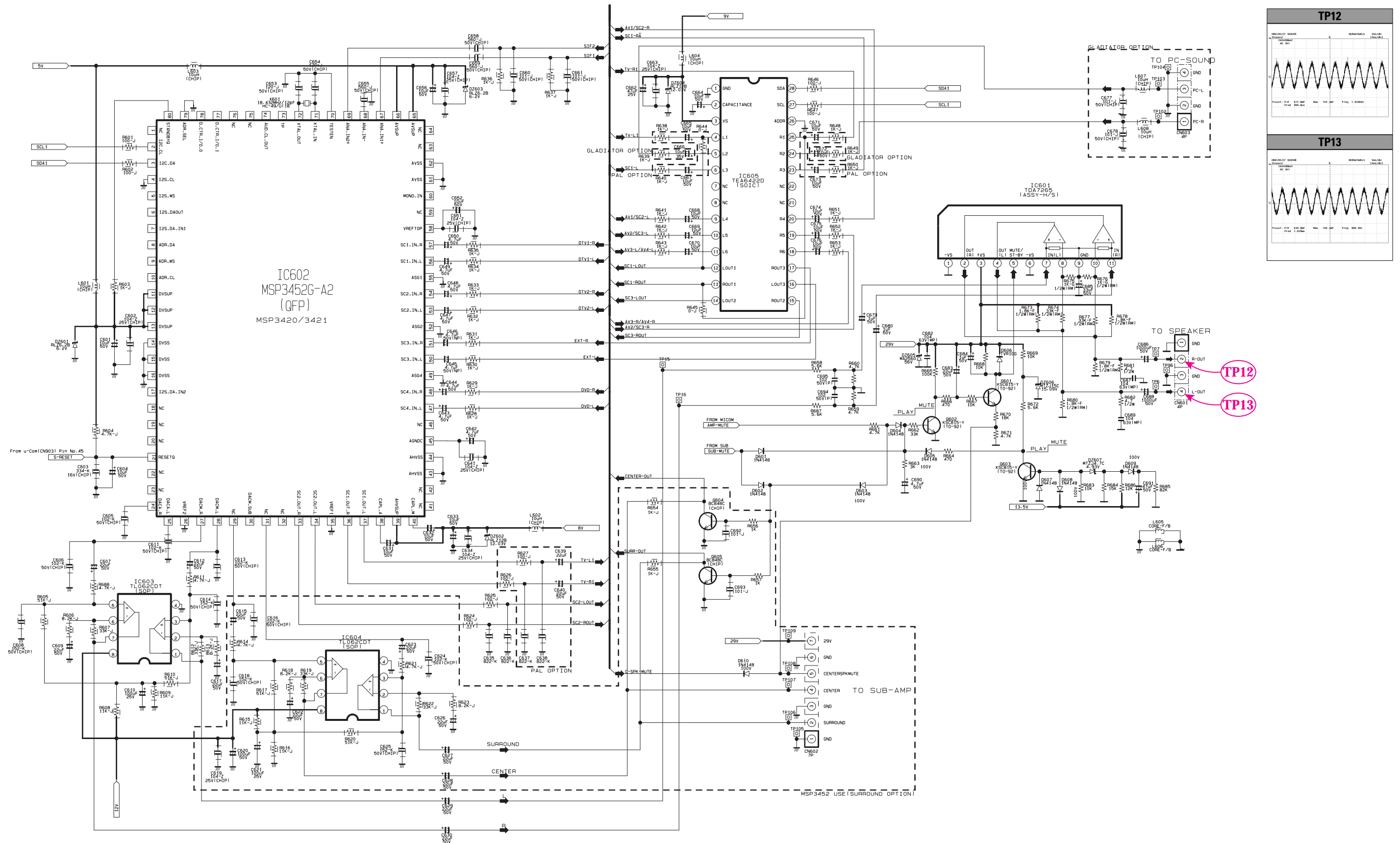

10-4 MAIN 4

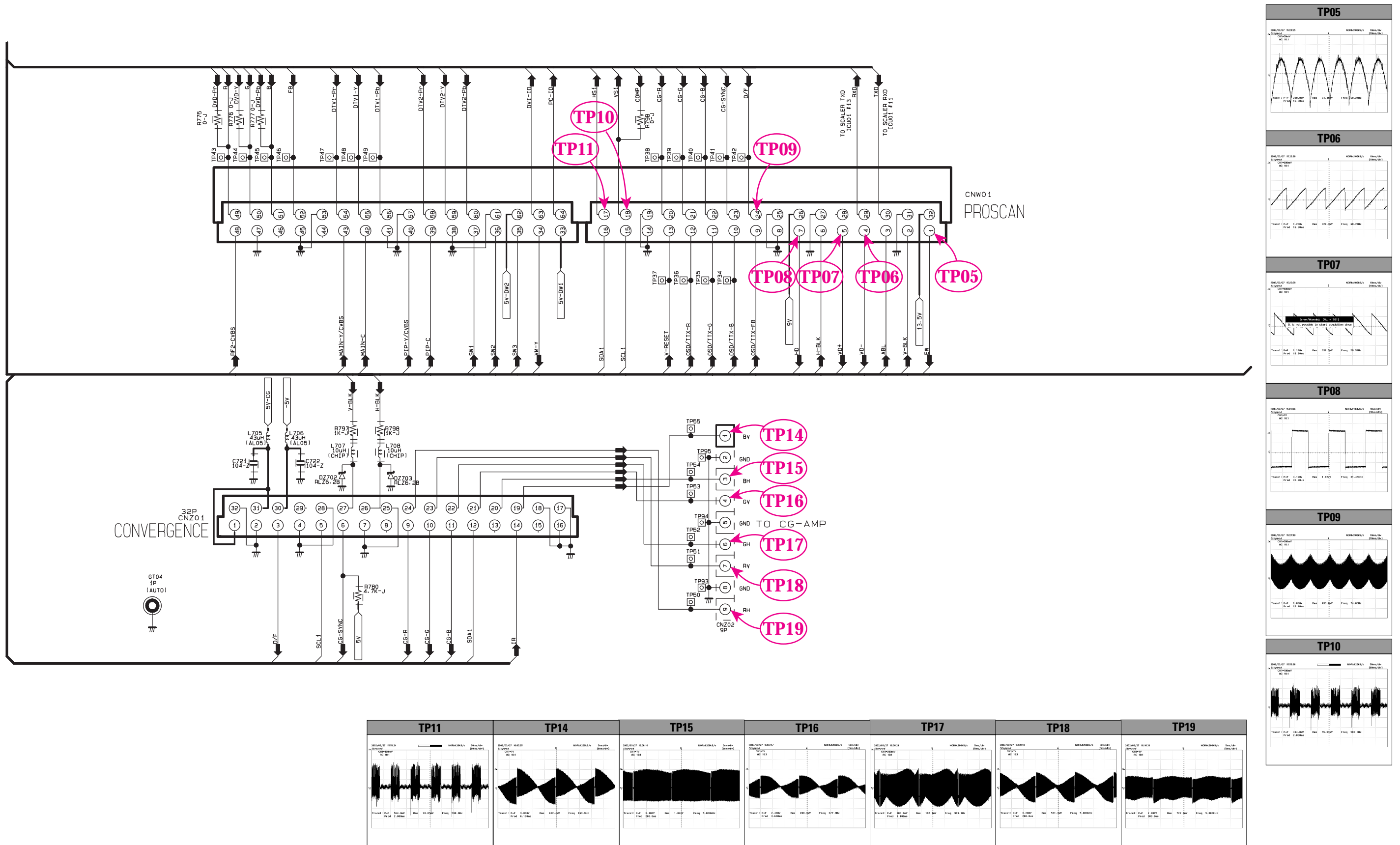

# 10-5 MICOM

CHASSIS : P55A & J54A  
MODEL :  
BOARD NAME : C2-MICOM  
COMMANDO-PJT  
2002/03/28

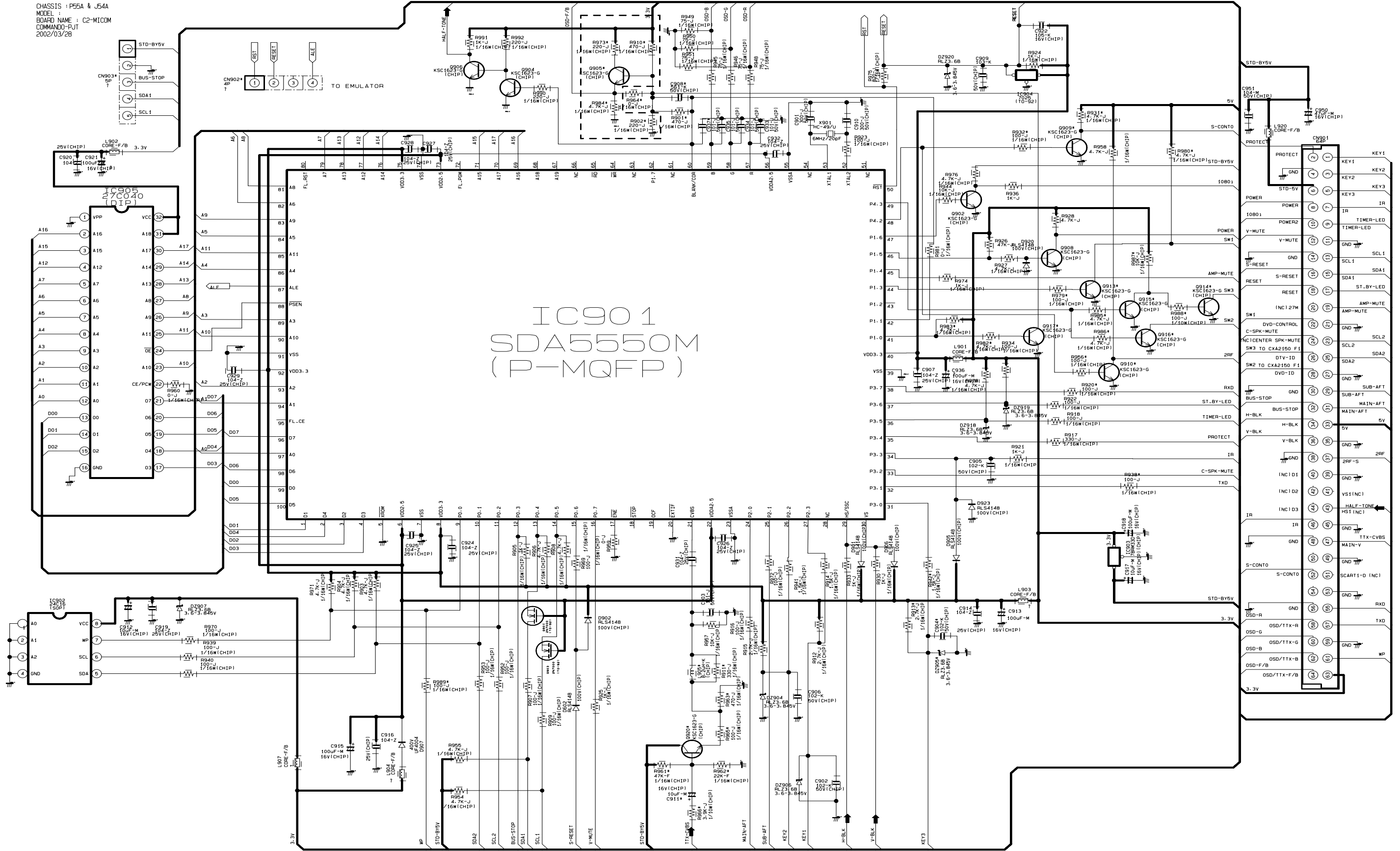

10-6 CRT

CHASSIS : P55A/J54B  
 MODEL : HCM4215W  
 PCB-CRT  
 2002/02/18

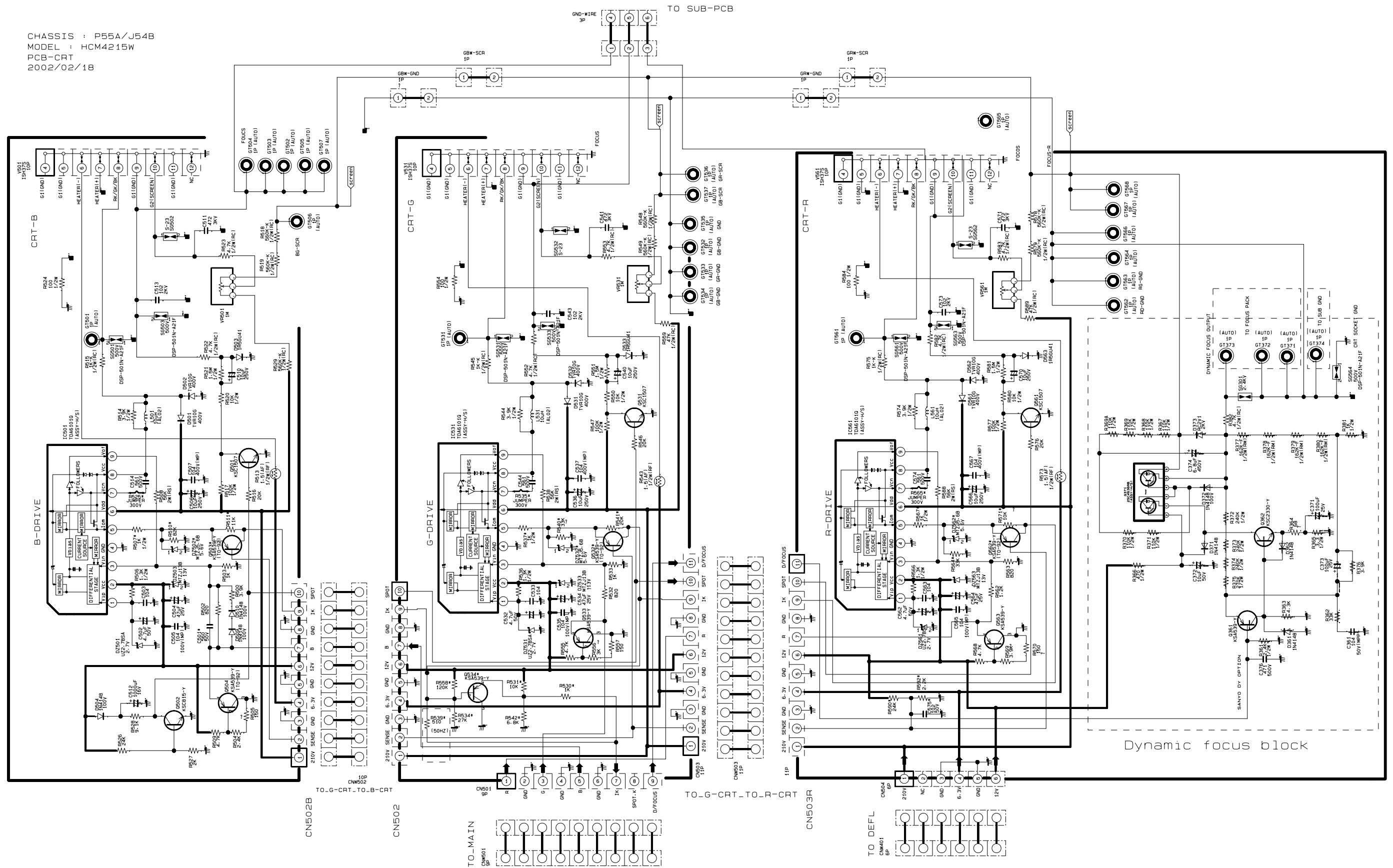

10-7 SUB 1

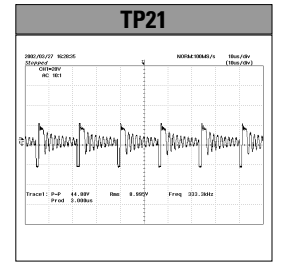
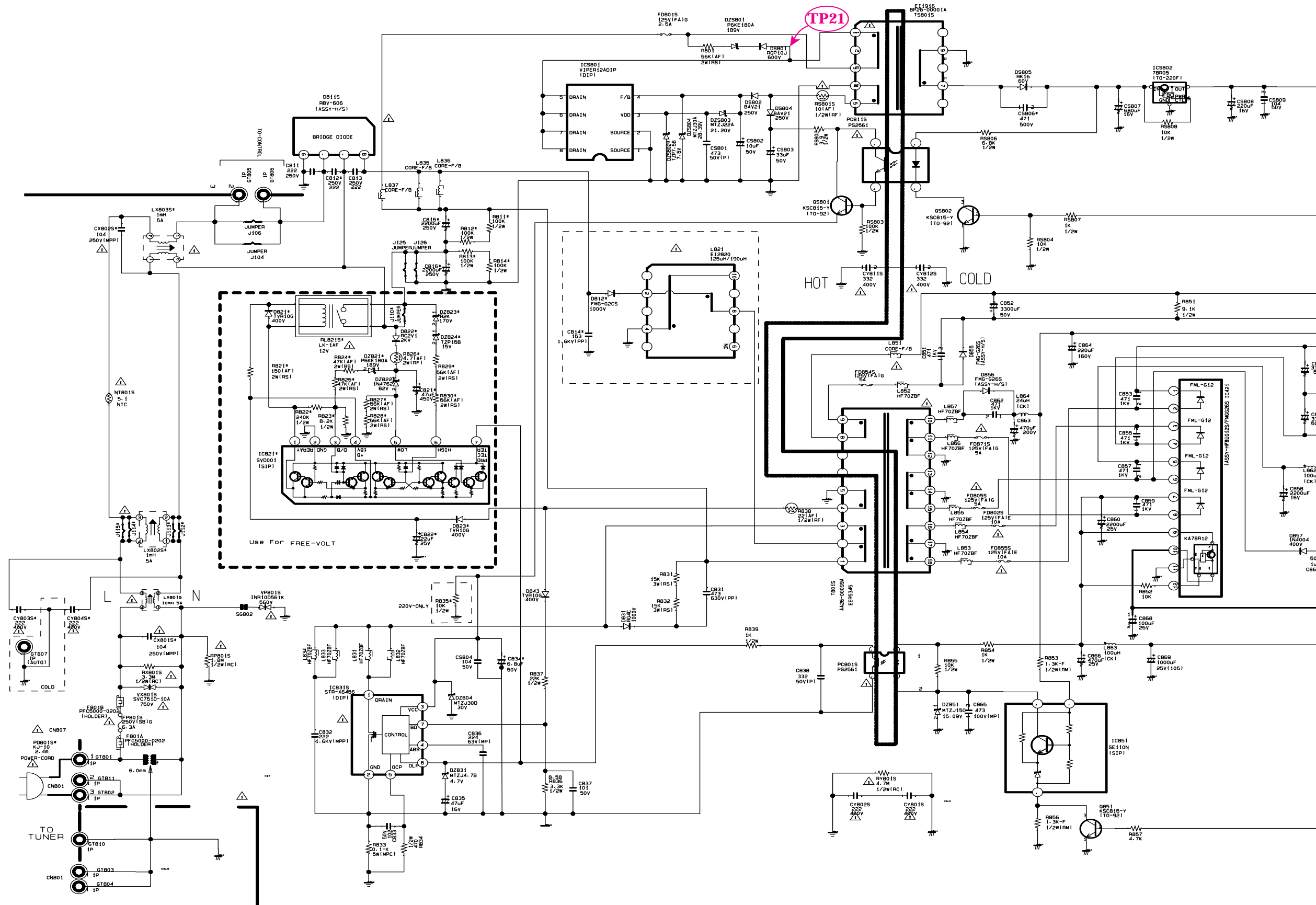

10-8 SUB 2

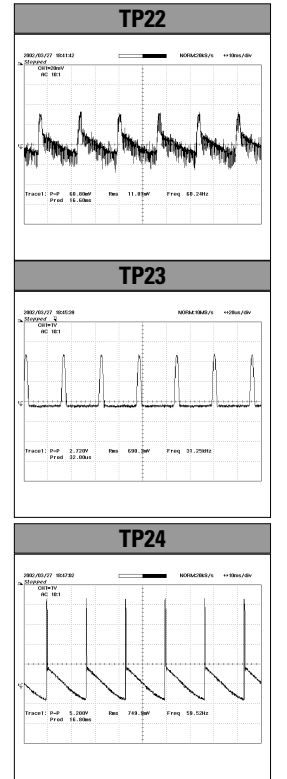
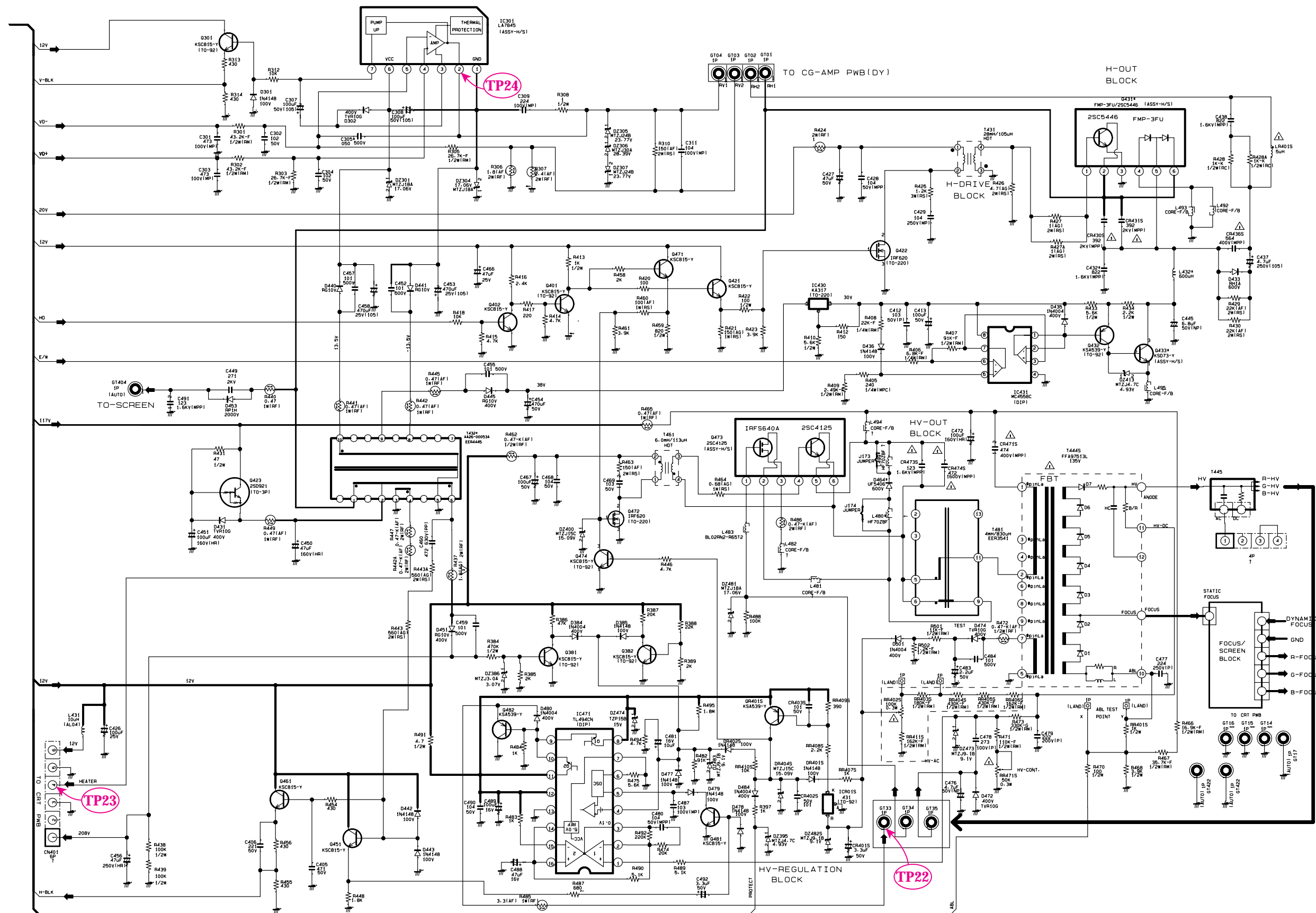

# 10-9 CONVERGENCE ( SDC11 - 1 )

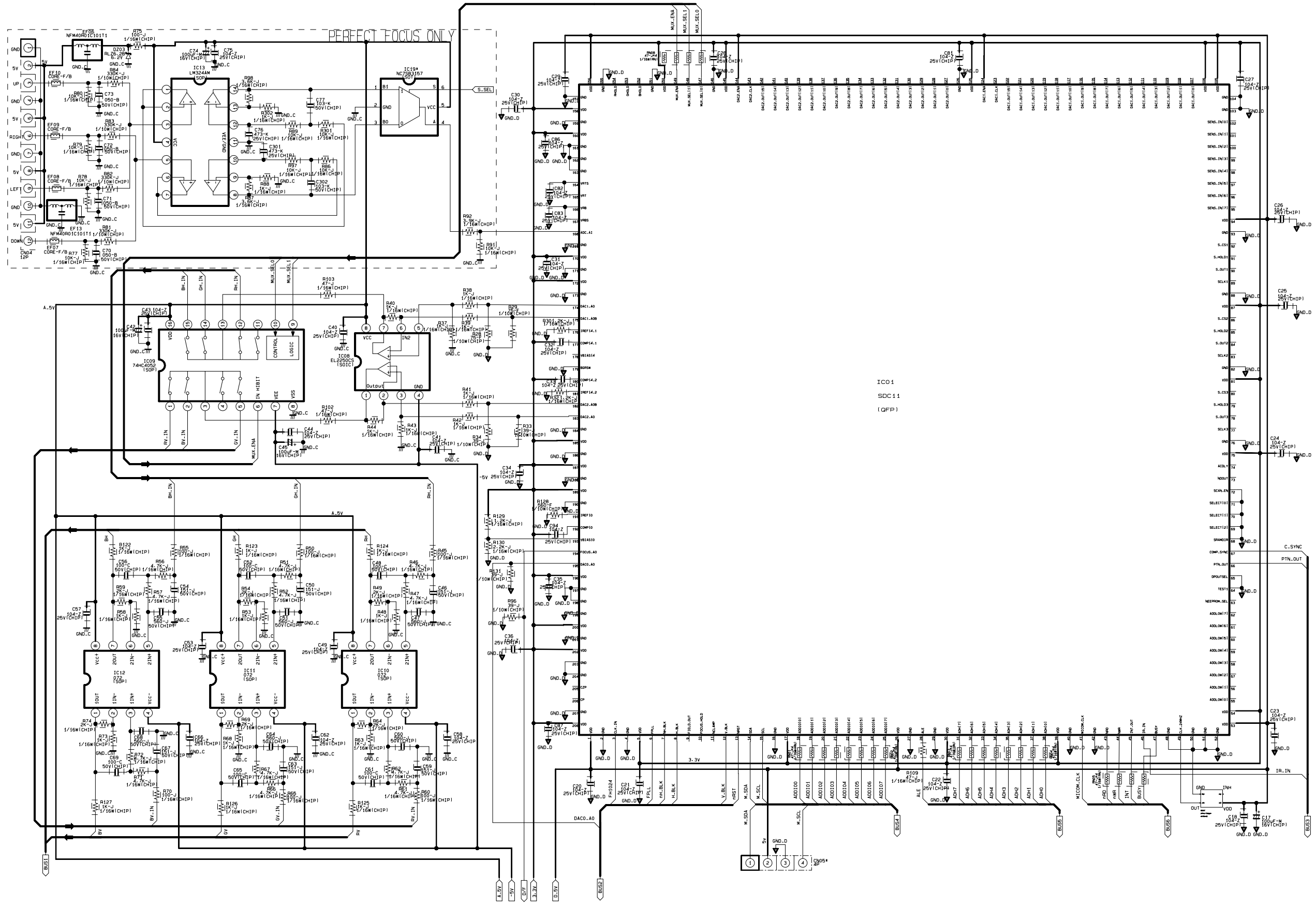

## 10-10 CONVERGENCE ( SDC11 - 2 )

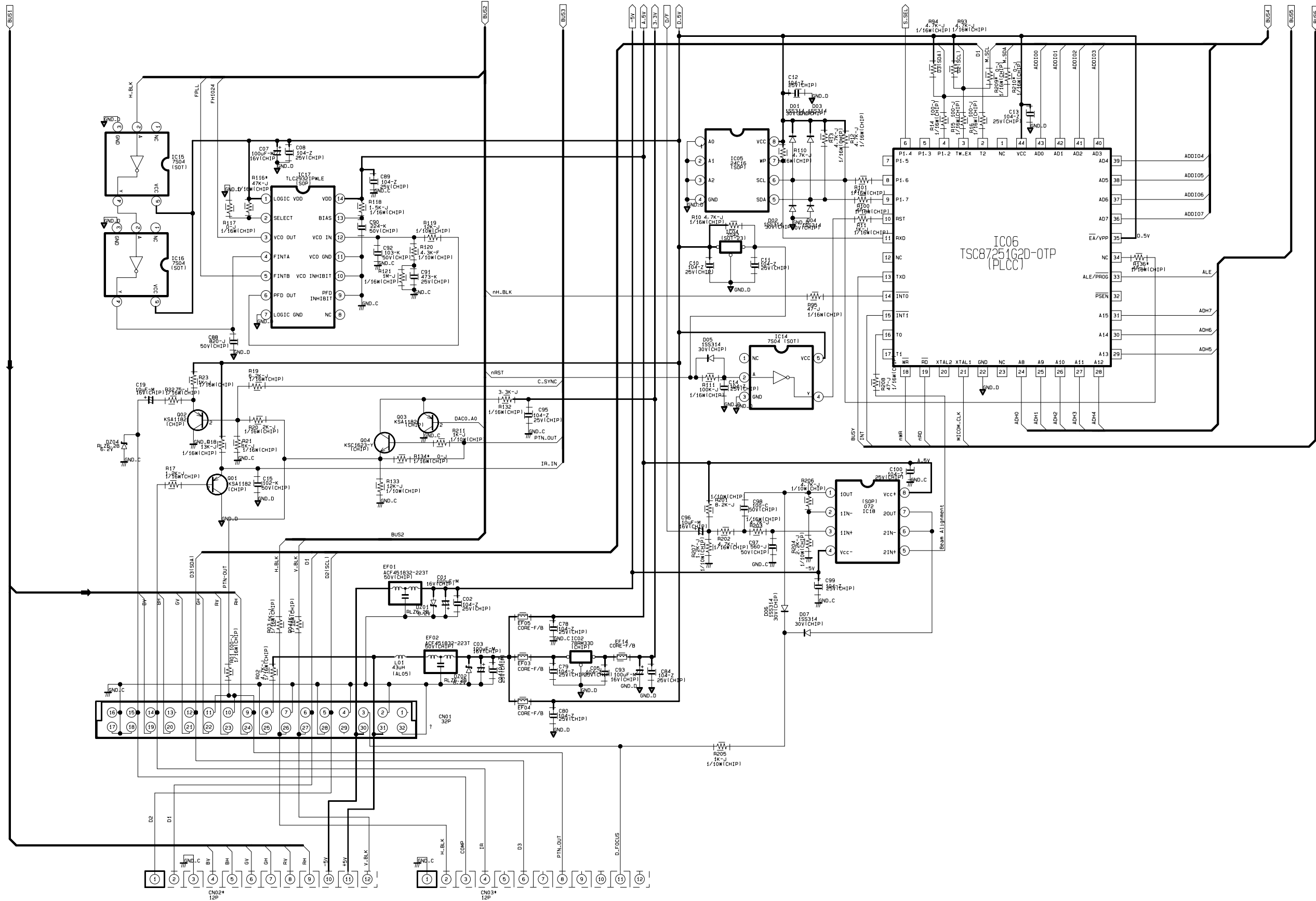



10-11 PRO SCAN 1

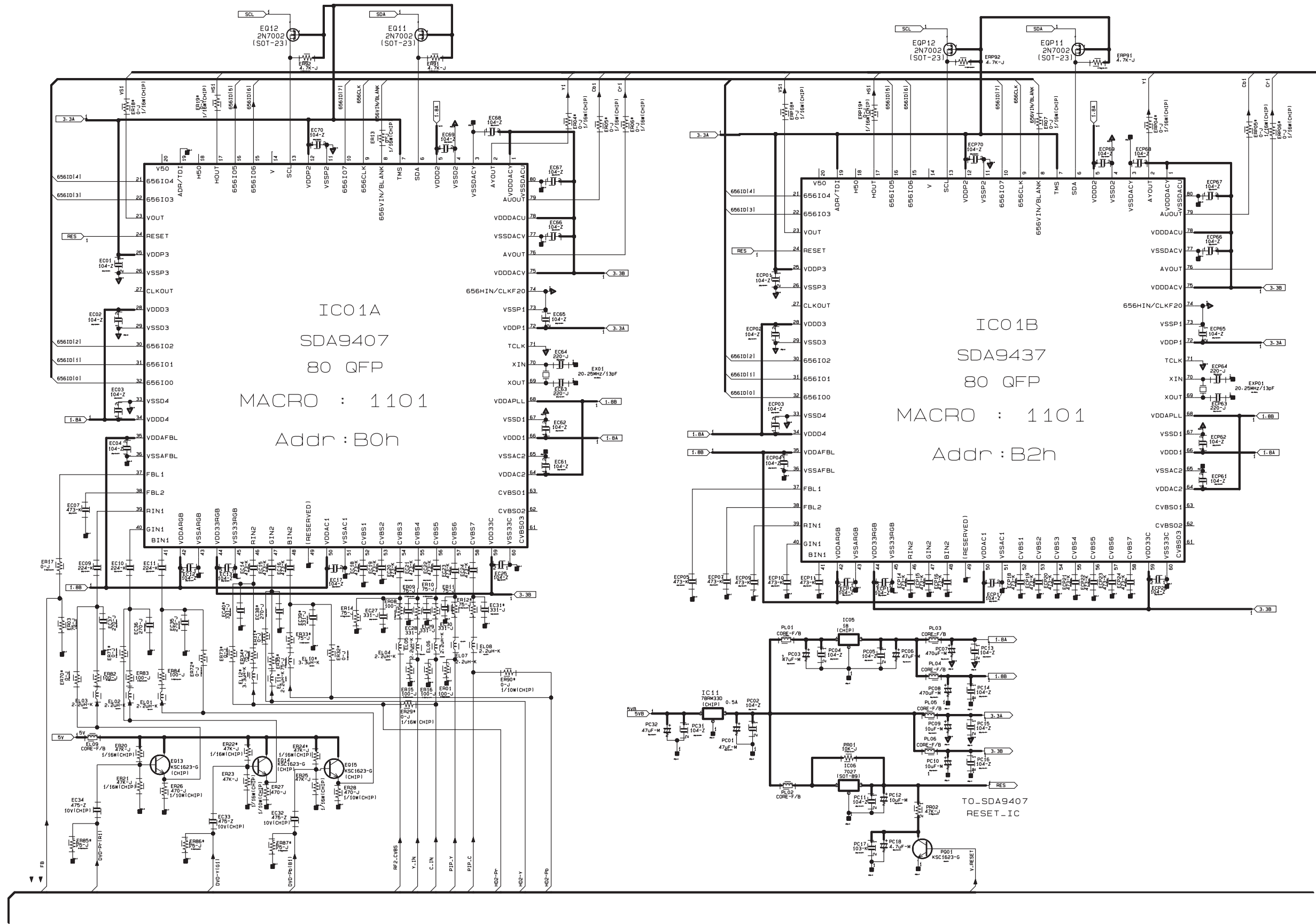



10-13 PRO SCAN 3

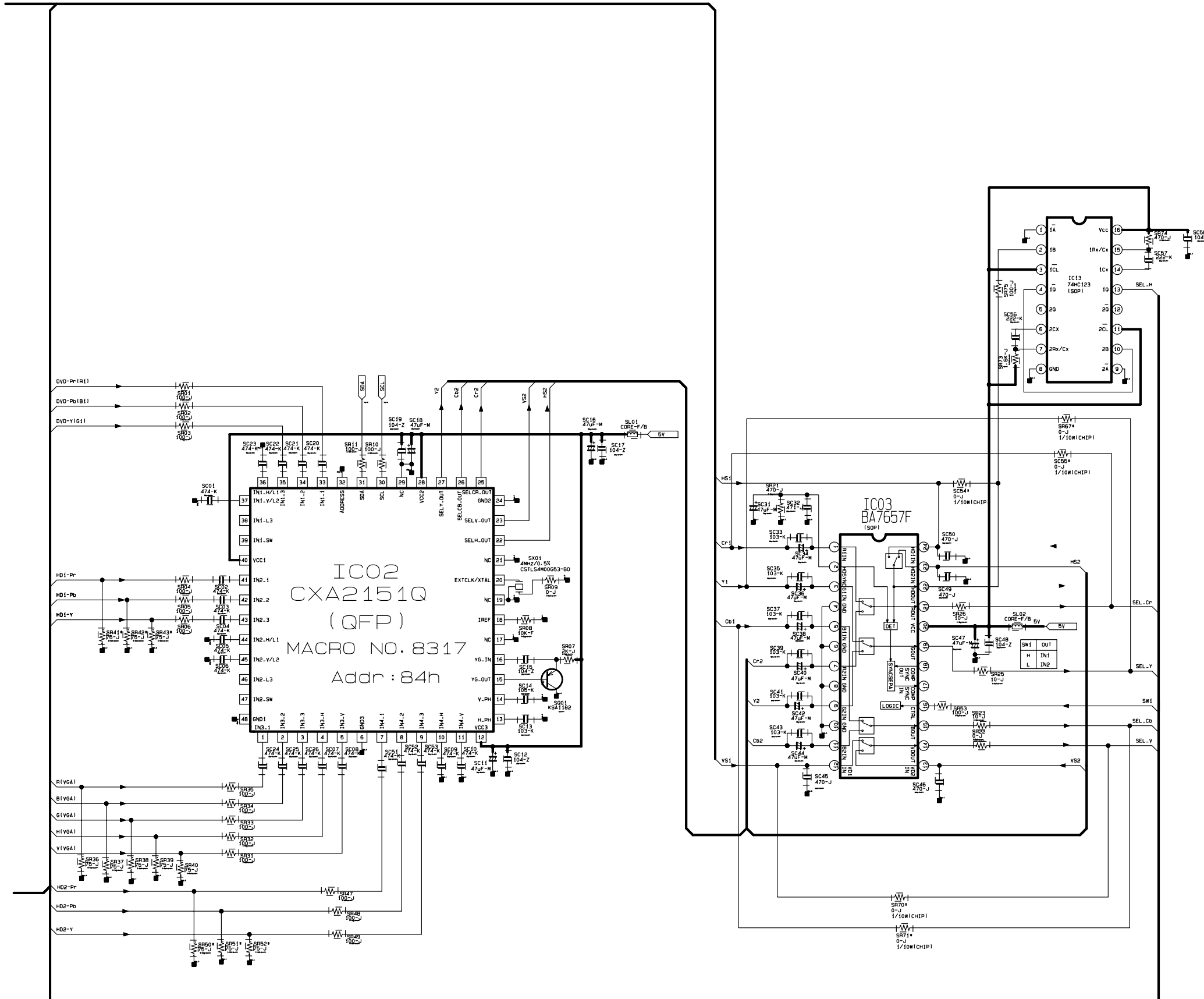

# 10-14 PRO SCAN 4

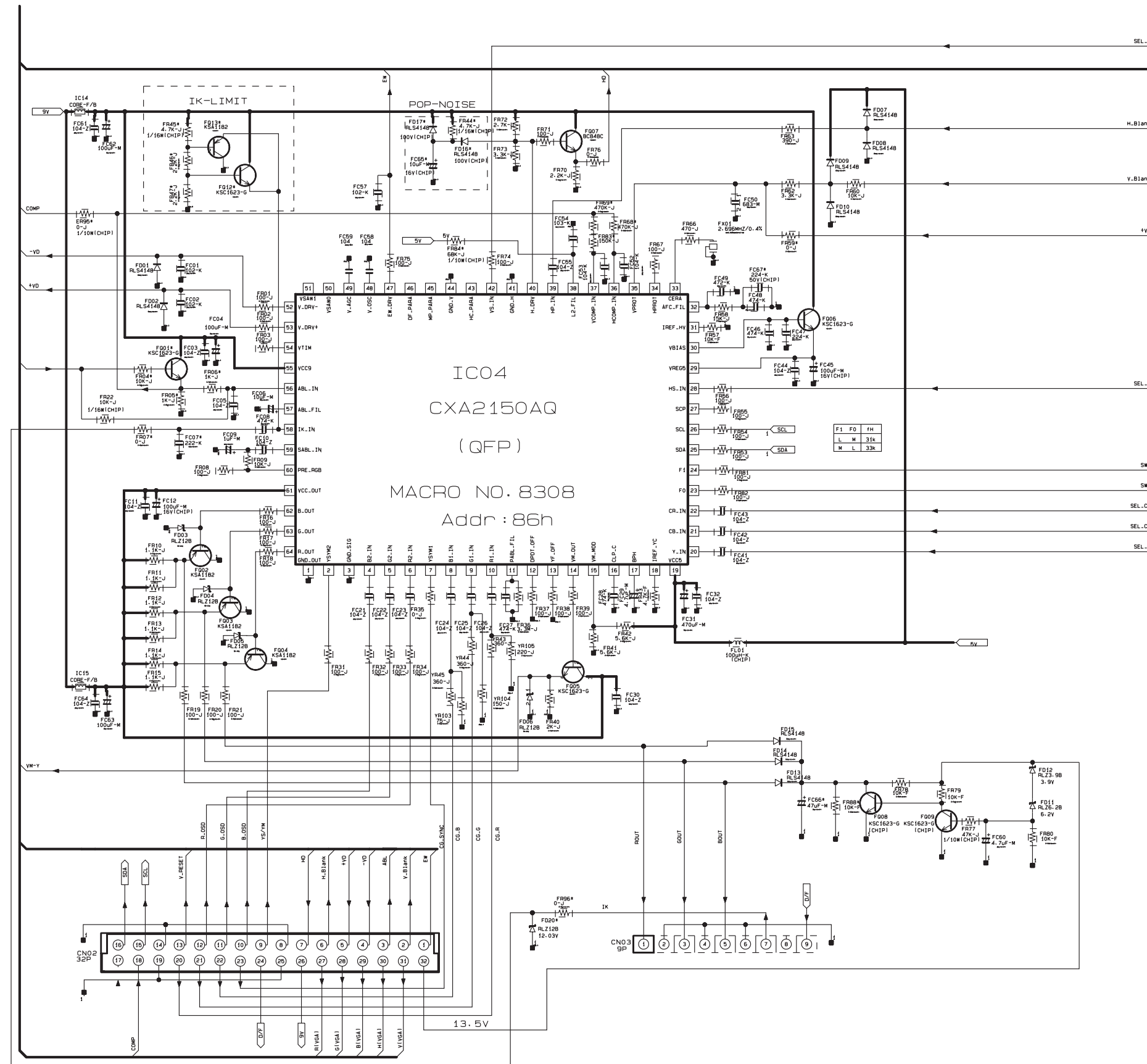

10-15 CG AMP

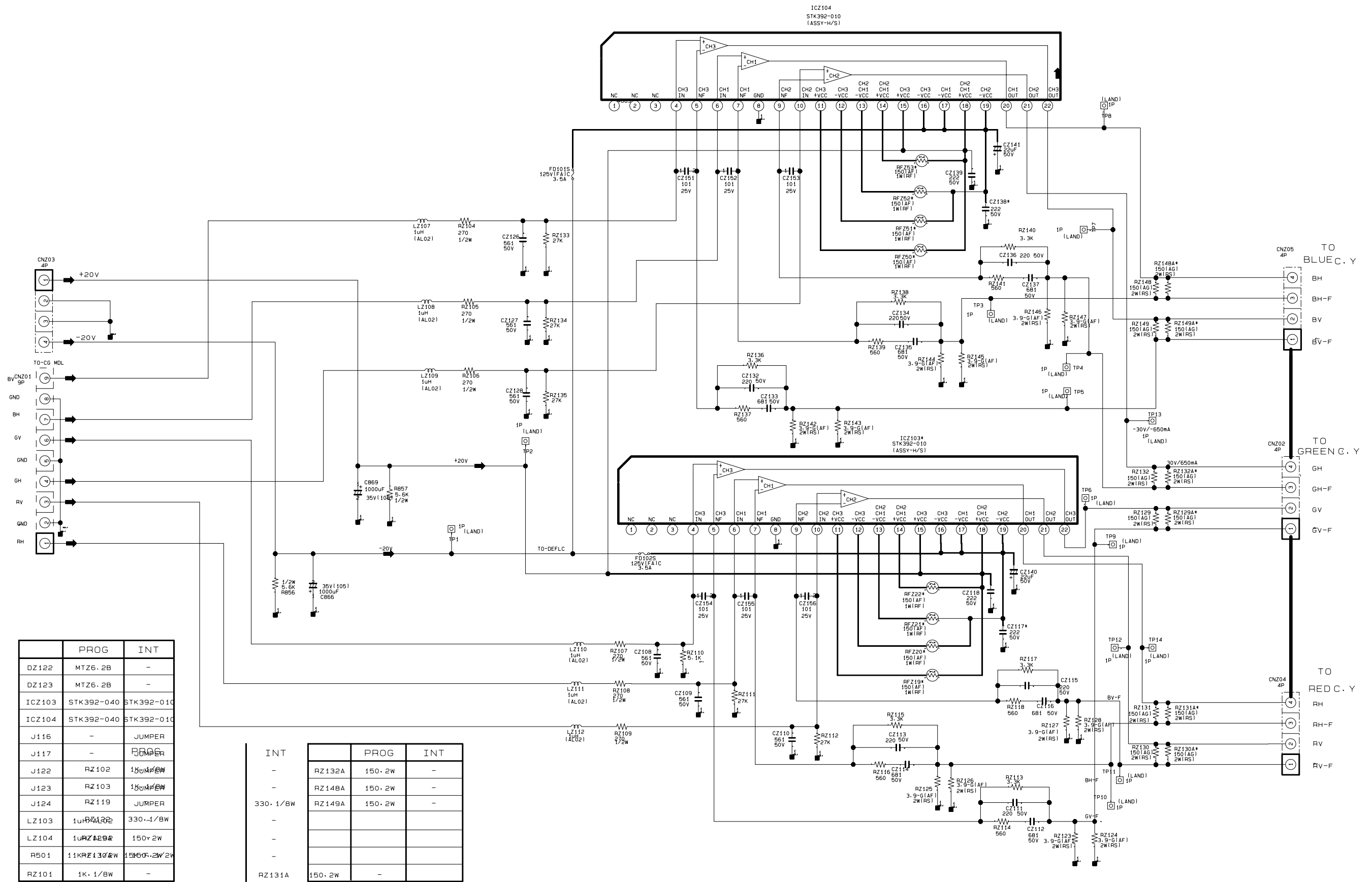

|        | PROG        | INT        |
|--------|-------------|------------|
| DZ122  | MTZ6-2B     | -          |
| DZ123  | MTZ6-2B     | -          |
| ICZ103 | STK392-040  | STK392-010 |
| ICZ104 | STK392-040  | STK392-010 |
| J116   | -           | JUMPER     |
| J117   | -           | JUMPER     |
| J122   | RZ102       | 150-1/2W   |
| J123   | RZ103       | 150-1/2W   |
| J124   | RZ119       | JUMPER     |
| LZ103  | 1uH AL02    | 330-1/2W   |
| LZ104  | 1uH AL02    | 150-2W     |
| R501   | 11K AF 1/2W | 150-2W     |
| RZ101  | 1K-1/2W     | -          |

| INT      | PROG   | INT    |
|----------|--------|--------|
| -        | RZ132A | 150-2W |
| -        | RZ148A | 150-2W |
| -        | RZ149A | 150-2W |
| 330-1/2W |        |        |
| -        |        |        |
| -        |        |        |
| -        |        |        |
| RZ131A   | 150-2W | -      |

10-16 AV FRONT

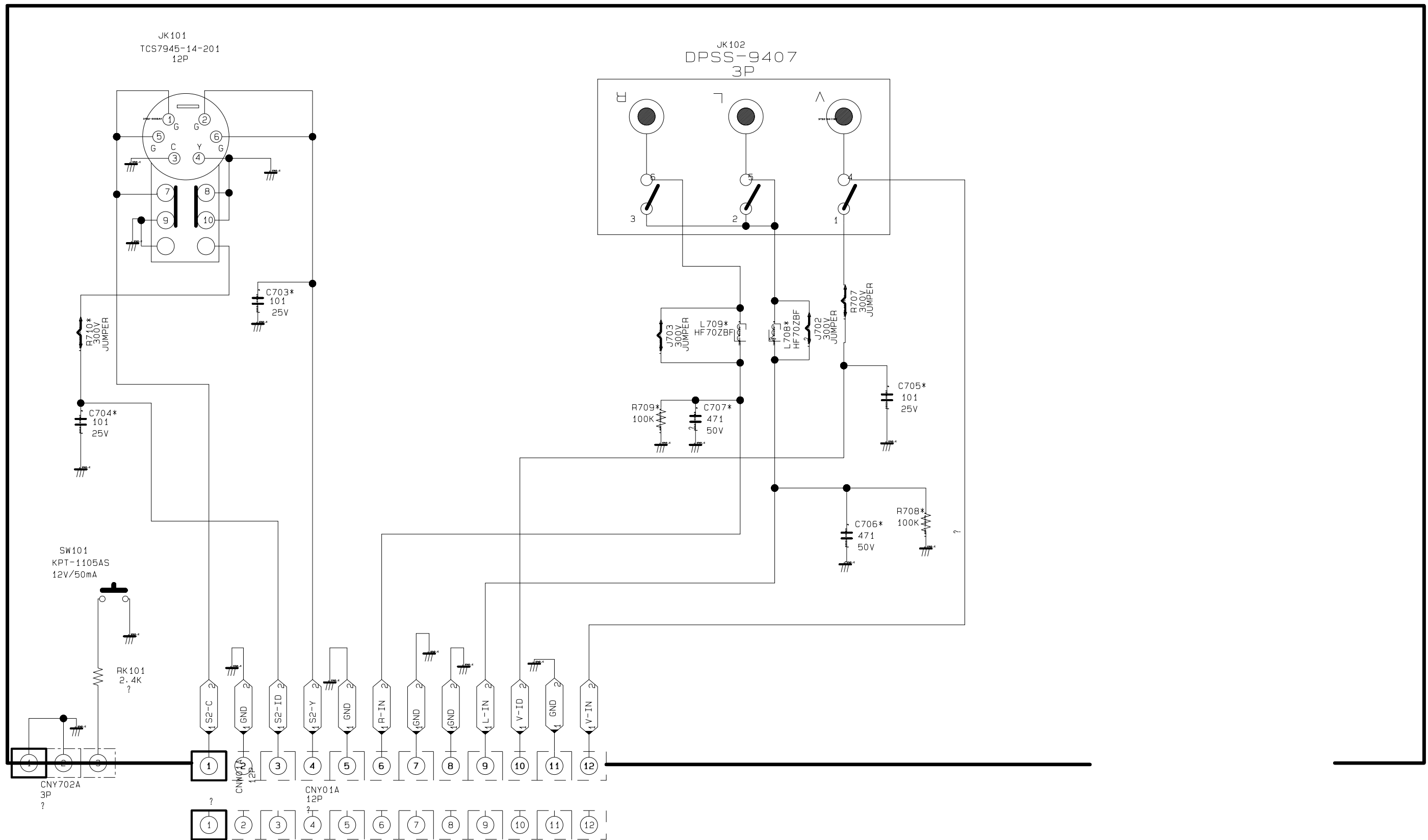

10-17 CONTROL

CHASSIS : W3  
 MODEL : P54A, P55A, P56A, J52A, J53A ALL MODEL  
 ASSY : PCB-CONTROL  
 PCB CODE : BP41-00001A  
 2002.01.16

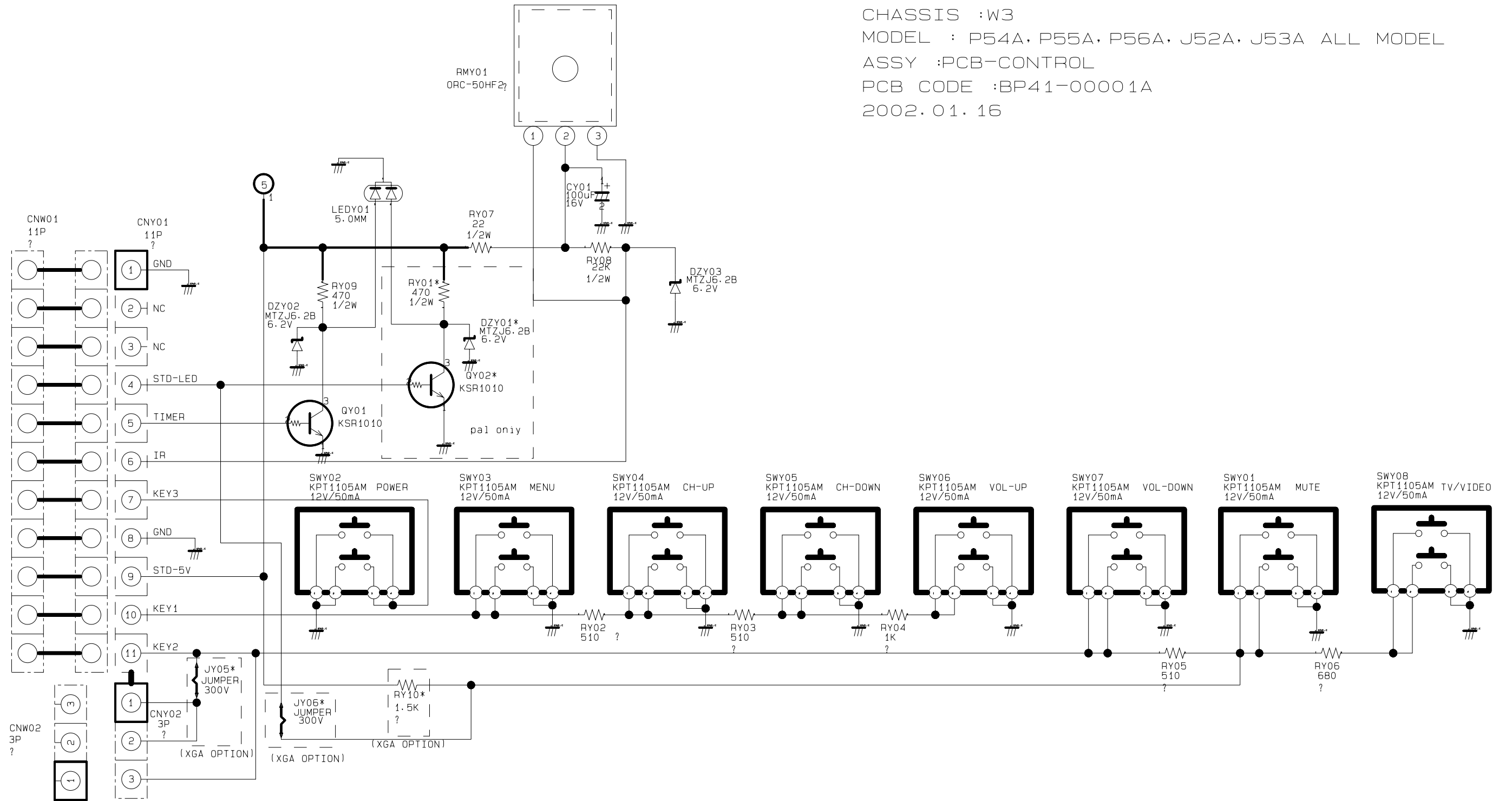

10-18 DY JACK, SENSOR

